

Owner's Manual

B093-00X-2E4U-X Resilience Gateway **B097-016/048 Console Server** **B098-016/048 and B098-016-V** **Infrastructure Manager**

WARRANTY REGISTRATION

Register your product today and be automatically entered to win an ISOBAR® surge protector in our monthly drawing!

[tripplite.com/warranty](https://www.tripplite.com/warranty)



1111 W. 35th Street, Chicago, IL 60609 USA • [tripplite.com/support](https://www.tripplite.com/support)

Copyright © 2022 Tripp Lite. All rights reserved.

Table of Contents

1. Introduction	7	4. Serial Port, Host, Device and User Configuration	34
2. Installation	8	4.1 Configure Serial Ports	34
2.1 Models	8	4.1.1 Common Settings	35
2.2 Power Connection	8	4.1.2 Console Server Mode	35
2.2.1 Models with Internal AC Power Supplies	8	4.1.3 SDT Mode	40
2.2.2 Models with External Power Supplies	9	4.1.4 Device (RPC, UPS, EMD) Mode	40
2.3 Network Connection	10	4.1.5 Terminal Server Mode	40
2.4 Serial Port Connection	10	4.1.6 Serial Bridging Mode	41
2.5 USB Port Connection	11	4.1.7. Syslog	41
2.6 Fitting Cellular SIM and Antennas	11	4.1.8 USB Consoles	42
2.6.1 B093-00X-2E4U-V Models	11	4.1.9 Link Layer Discovery Protocol (LLDP)	42
2.6.2 B098-016-V Models	11	4.2 Add and Edit Users	43
3. System Configuration	12	4.2.1 Set Up New Group	44
3.1 Management Console Connection	12	4.2.2 Set Up New Users	45
3.1.1 Connected Computer Setup	12	4.3 Authentication	46
3.1.2 Browser Connection	13	4.4 Network Hosts	46
3.2 Administrator Setup	14	4.5 Trusted Networks	48
3.2.1 Change Default Root System Password	14	4.6 Serial Port Cascading	49
3.2.2 Set Up New Administrator	14	4.6.1 Automatically Generate and Upload SSH keys	50
3.2.3 Name the System	15	4.6.2 Manually Generate and Upload SSH Keys	51
3.3 Network Configuration	16	4.6.3 Configure the Secondary Units and their Serial Ports	52
3.3.1 IPv6 Configuration	17	4.6.4 Managing the Secondary Serial Ports	53
3.3.2 Dynamic DNS (DDNS) Configuration	17	4.7 Managed Devices	53
3.4 Services and Service Access	19	4.8 IPsec VPN	55
3.4.1 Brute Force Protection	22	4.8.1 Enable the VPN Gateway	55
3.5 Communications Software	23	4.9 OpenVPN	57
3.5.1 SDT Connector	23	4.9.1 Enable the OpenVPN	58
3.5.2 PuTTY	24	4.9.2 Configure as Server or Client	59
3.5.3 SSHTerm	24	4.9.3 Set Up Windows OpenVPN Client and Server	62
3.6 Management Network Configuration	25	4.10 PPTP VPN	65
3.6.1 Enable the Management LAN	25	4.10.1 Enable the PPTP VPN Server	66
3.6.2 Configure the DHCP Server	27	4.10.2 Add a PPTP User	67
3.6.3 Select Failover or Broadband OOB	29	4.10.3 Set Up a Remote PPTP Client	68
3.6.4 Aggregating the Network Ports	30	4.11 IP Passthrough	69
3.6.5 Static Routes	31	4.11.1 Downstream Router Setup	69
3.7 Configuration over DHCP (ZTP)	31	4.11.2 IP Passthrough Pre-Configuration	69
		4.11.3 IP Passthrough Configuration	70
		4.11.4 Service Intercepts	70
		4.11.5 IP Passthrough Status	70
		4.11.6 Caveats	71

Table of Contents

5. Firewall, Failover and OOB Access	72	6.3 SDT Connector to Management Console	110
5.1 Dialup Modem Connection	72	6.4 SDT Connector: Telnet or SSH Connect to Serially Attached Devices	111
5.2 OOB Dial-In Access	72	6.5 Using SDT Connector for Out-of-Band (OOB) Connection to the Gateway	112
5.2.1 Configure Dial-In PPP	73	6.6 Importing (and Exporting) Preferences	113
5.2.2 Using SDT Connector Client	75	6.7 SDT Connector Public Key Authentication	113
5.2.3 Set Up Windows XP or Later Client	75	6.8 Setting up SDT for Remote Desktop Access	114
5.2.4 Set Up Earlier Windows Clients	76	6.8.1 Enable Remote Desktop on the Target Windows Computer to Be Accessed	114
5.2.5 Set Up Linux Clients	76	6.8.2 Configure the Remote Desktop Connection Client	115
5.3 Dial-Out Access	76	6.9 SDT SSH Tunnel for VNC	116
5.3.1 Always-On Dial-Out	77	6.9.1 Install and Configure the VNC Server on the Computer to be Accessed	116
5.3.2 Failover Dial-Out	78	6.9.2 Install, Configure and Connect the VNC Viewer	118
5.4 OOB Broadband Ethernet Access	79	6.10 Using SDT to IP Connect to Hosts that are Serially Attached to the Gateway	119
5.5 Broadband Ethernet Failover	80	6.10.1 Establish a PPP Connection between the Host COM Port and Console Server	120
5.6 Cellular Modem Connection	81	6.10.2 Set Up SDT Serial Ports on Console Server	122
5.6.1 Connecting to a 4G LTE Carrier Network	82	6.10.3 Set Up SDT Connector to SSH Port Forward over Console Server Serial Port	122
5.6.2 Verifying the Cellular Connection	83	6.11 SSH Tunneling Using Other SSH Clients (e.g. PuTTY)	122
5.6.3 Cellular Modem Watchdog	84	6.12. VNC Security	125
5.6.4 Dual SIM Failover	85		
5.6.5 Automatic SIM Slot Detection	85		
5.6.6 Multi-Carrier Cellular Support	86		
5.7 Cellular Operation	87		
5.7.1 Set Up OOB Access	88		
5.7.2 Set Up Cellular Failover	89		
5.7.3 Cellular Routing	90		
5.7.4 Set Up Cellular CSD Dial-In	91		
5.8 Firewall and Forwarding	92		
5.8.1 Configuring Network Forwarding and IP Masquerading	92		
5.8.2 Configuring Client Devices	94		
5.8.3 Port / Protocol Forwarding	96		
5.8.4 Firewall Rules	98		
5.8.5 Packet State Matching in Firewall Rules	100		
6. SSH Tunnels and SDT Connector	102		
6.1 Configuring for SSH Tunneling to Hosts	102		
6.2 SDT Connector Client Configuration	102		
6.2.1 SDT Connector Client Installation	103		
6.2.2 Configuring a New Gateway in the SDT Connector Client	103		
6.2.3 Auto-Configure SDT Connector Client with the User's Access Privileges	104		
6.2.4 Make an SDT Connection Through the Gateway to a Host	105		
6.2.5 Manually Adding Hosts to the SDT Connector Gateway	105		
6.2.6 Manually Adding New Services to the New Hosts	106		
6.2.7 Adding a Client Program to Be Started for the New Service	108		
6.2.8 Dial-In Configuration	109		

Table of Contents

7. Alerts, Auto-Response and Logging	126	8. Power, Environment and Digital I/O	147
7.1 Configure Auto-Response	126	8.1 Remote Power Control (RPC)	147
7.2 Check Conditions	128	8.1.1 RPC Connection	147
7.2.1 Environmental	128	8.1.2 RPC Access, Privileges and Alerts	151
7.2.2 Alarms and Digital Inputs	128	8.1.3 User Power Management	151
7.2.3 UPS/Power Supply	129	8.1.4 RPC Status	152
7.2.4 UPS Status	129	8.2 Uninterruptible Power Supply (UPS) Control	153
7.2.5 Serial Login, Signal or Pattern	130	8.2.1 Managed UPS Connections	153
7.2.6 USB Console Status	130	8.2.2 Remote UPS Management	156
7.2.7 ICMP Ping	131	8.2.3 Controlling UPS Powered Computers	157
7.2.8 Link Layer Discovery Protocol (LLDP)	132	8.2.4 UPS Alerts	157
7.2.9 Cellular Data	132	8.2.5 UPS Status	158
7.2.10 Custom Check	133	8.2.6 Overview of Network UPS Tools (NUT)	159
7.2.11 SMS Command	133	8.3 Environmental Monitoring	160
7.2.12 Log In/Out Check	133	8.3.1 Connecting the EMD and its Sensors	161
7.2.13 Network Interface Event	135	8.3.2 Adding EMDs and Configuring the Sensors	162
7.2.14 Routed Data Usage Check	136	8.3.3 Environmental Alerts	163
7.3 Trigger Actions	136	8.3.4 Environmental Status	164
7.3.1 Send Email	137	9. Authentication	165
7.3.2 Send SMS	137	9.1 Authentication Configuration	165
7.3.3 Perform RPC Action	137	9.1.1 Local Authentication	165
7.3.4 Run Custom Script	137	9.1.2 TACACS Authentication	166
7.3.5 Send SNMP Trap	137	9.1.3 RADIUS Authentication	167
7.3.6 Send Nagios Event	138	9.1.4 LDAP Authentication	168
7.3.7 Perform Interface Action	138	9.1.5 RADIUS/TACACS User Configuration	171
7.4 Resolve Actions	138	9.1.6 Group Support with Remote Authentication	172
7.5 Configure SMTP, SMS, SNMP and/or Nagios Service for Alert Notifications	139	9.1.7 Remote Groups with RADIUS Authentication	172
7.5.1 Send Email Alerts	139	9.1.8 Remote Groups with LDAP Authentication	174
7.5.2 Send SMS Alerts	140	9.1.9 Remote Groups with TACACS+ Authentication	175
7.5.3 Send SNMP Trap Alerts	141	9.1.10 Idle Timeout	176
7.5.4 Send Nagios Event Alerts	143	9.1.11 Kerberos Authentication	176
7.6 Logging	143	9.1.12 Authentication Testing	177
7.6.1 Log Storage	144	9.2 PAM (Pluggable Authentication Modules)	177
7.6.2 Serial Port Logging	145	9.3 SSL Certificate	178
7.6.3 Network TCP and UDP Port Logging	145		
7.6.4 Auto-Response Event Logging	146		
7.6.5 Power Device Logging	146		

Table of Contents

10. Nagios Integration	181	14. Configuration from the Command Line	212
10.1 Nagios Overview	181	14.1 Accessing Config from the Command Line	212
10.2 Configuring Nagios Distributed Monitoring	181	14.1.1 Serial Port Configuration	215
10.2.1 Enable Nagios on the Console Server	182	14.1.2 Adding and Removing Users	216
10.2.2 Enable NRPE Monitoring	183	14.1.3 Adding and Removing User Groups	217
10.2.3 Enable NSCA Monitoring	184	14.1.4 Authentication	218
10.2.4 Configure Selected Serial Ports for Nagios Monitoring	185	14.1.5 Network Hosts	219
10.2.5 Configure Selected Network Hosts for Nagios Monitoring	185	14.1.6 Trusted Networks	220
10.2.6 Configure the Upstream Nagios Monitoring Host	186	14.1.7 Cascaded Ports	220
10.3 Advanced Distributed Monitoring Configuration	187	14.1.8 UPS Connections	221
10.3.1 Sample Nagios Configuration	187	14.1.9 RPC Connections	222
10.3.2 Basic Nagios Plug-Ins	189	14.1.10 Environmental	223
10.3.3 Additional Plug-Ins	190	14.1.11 Managed Devices	223
10.3.4 Number of Supported Devices	191	14.1.12 Port Log	224
10.3.5 Distributed Monitoring Usage Scenarios	192	14.1.13 Alerts	224
11. System Management	194	14.1.14 SMTP and SMS	226
11.1 System Administration and Reset	194	14.1.15 SNMP	227
11.2 Upgrade Firmware	195	14.1.16 Administration	227
11.3 Configure Date and Time	195	14.1.17 IP Settings	227
11.4 Configuration Backup	297	14.1.18 Date and Time Settings	228
11.5 Delayed Configuration Commit	298	14.1.19 Dial-In Settings	229
11.6 FIPS Mode	201	14.1.20 DHCP Server	229
12. Status Reports	202	14.1.21 Services	230
12.1 Port Access and Active Users	202	14.1.22 NAGIOS	231
12.2 Statistics	203	15. Advanced Configuration	232
12.3 Support Reports	203	15.1 Custom Scripting	232
12.4 Syslog	204	15.1.1 Custom Script to Run when Booting	232
12.5 Dashboard	205	15.1.2 Running Custom Scripts when Alerts are Triggered	232
12.5.1 Configuring the Dashboard	205	15.1.3 Sample Script - Power Cycling on Pattern Match	233
12.5.2 Creating Custom Widgets for the Dashboard	207	15.1.4 Sample Script - Multiple Email Notifications on Each Alert	233
13. Management	208	15.1.5 Deleting Configuration Values from the CLI	234
13.1 Device Management	208	15.1.6 Power Cycle Any Device upon a Ping Request Failure	236
13.2 Port and Host Logs	208	15.1.7 Running Custom Scripts when a Configurator is Invoked	237
13.3 Terminal Connection	209	15.1.8 Backing-Up the Configuration and Restoring Using a Local USB Drive	237
13.3.1 Web Terminal	209	15.1.9 Backing Up the Configuration Off-Box	238
13.3.2 SDT Connector Access	211	15.2 Advanced Portmanager	239
13.4 Power Management	211	15.2.1 Portmanager Commands	239
		15.2.2 External Scripts and Alerts	242

Table of Contents

15.3 Raw Access to Serial Ports	243	15.16 Internal Storage	267
15.3.1 Access to Serial Ports	243	15.16.1 Filesystem Location of FTP/TFTP Directory	267
15.3.2 Accessing the Console/ Modem Port	243	15.16.2 Filesystem Location of Portmanager Logs	267
15.4 IP Filtering	244	15.16.3 Configuring FTP/TFTP Directory	268
15.5 SNMP Status Reporting	244	15.16.4 Mounting a Preferred USB Disk by Label	268
15.5.1 Retrieving Status Information using SNMP	244	APPENDIX A: Linux Commands and Source Code	269
15.5.2 Check Firewall Rules	245	APPENDIX B: Hardware Specification	273
15.5.3 Enable SNMP Service	245	APPENDIX C: Safety and Certifications	273
15.5.4 Adding Multiple Remote SNMP Managers	247	APPENDIX D: Connectivity, TCP Ports and Serial I/O	274
15.6 Secure Shell (SSH) Public Key Authentication	248	APPENDIX E: Terminology	277
15.6.1 SSH Overview	248	APPENDIX F: End User License Agreements	280
15.6.2 Generating Public Keys (Linux)	249	APPENDIX G: Service and Limited Warranty	885
15.6.3 Installing the SSH Public/Private Keys (Clustering)	250		
15.6.4 Installing SSH Public Key Authentication (Linux)	250		
15.6.5 Generating Public/Private Keys for SSH (Windows)	251		
15.6.6 Fingerprinting	253		
15.6.7 SSH Tunneled Serial Bridging	253		
15.6.8 SDT Connector Public Key Authentication	256		
15.7 Secure Sockets Layer (SSL) Support	256		
15.8 HTTPS	256		
15.8.1 Generating an Encryption Key	256		
15.8.2 Generating a Self-Signed Certificate with OpenSSL	257		
15.8.3 Installing the Key and Certificate	257		
15.8.4 Launching the HTTPS Server	257		
15.9 Power Strip Control	258		
15.9.1 PowerMan Tool	258		
15.9.2 Pmpower tool	259		
15.9.3 Adding New RPC Devices	260		
15.10 IPMItool	261		
15.11 Custom Development Kit (CDK)	263		
15.12 SMS Server Tools	264		
15.13 Multicast	264		
15.14 Bulk Provisioning	265		
15.15 Zero Touch Provisioning	265		
15.15.1 Preparation	265		
15.15.2 Example ISC DHCP Server Configuration	265		
15.15.3 Set Up an Untrusted LAN	266		
15.15.4 How it Works	266		

Important Safety Instructions

Please take care to follow the safety precautions below when installing and operating the console server:

- Do not remove the metal covers. There are no operator serviceable components inside. Opening or removing the cover may expose you to dangerous voltage that may cause fire or electric shock. Refer all service to Tripp Lite qualified personnel.
- To avoid electric shock the power cord protective grounding conductor must be connected through to ground.
- Always pull on the plug, not the cable, when disconnecting the power cord from the socket.

Do not connect or disconnect the console server during an electrical storm. Also, it is recommended you use a Tripp Lite surge protector or UPS to protect the equipment from transient power fluctuations.



Proper backup systems and necessary safety devices should be utilized to protect against injury, death or property damage due to system failure. Such protection is the responsibility of the user.

This console server device is not approved for use as a life-support or medical system.

Any changes or modifications made to this console server device without the explicit approval or consent of Tripp Lite will void Tripp Lite of any liability or responsibility of injury or loss caused by any malfunction.

This equipment is for indoor use and all the communication wirings are limited to inside of the building.

1. Introduction

Tripp Lite's B093-, B097- and B098-Series console / terminal servers are among the most advanced platform available today. In a secure, desktop/rack-mountable appliance, B093-, B097- and B098-console servers offer in-band, out-band and cellular management solutions for serial console ports, servers, virtual servers, service processors, UPS systems and PDUs, environmental monitoring and more. Available in 4- and 8-port models, B093-, B097- and B098- console / terminal servers allow system administrators to securely access and control their data centers and networks from anywhere in the world. These enterprise-grade units are equipped with a built-in cellular modem, dual Gigabit Ethernet NIC, 4 GB internal NAND flash, four USB 2.0 console ports, a digital I/O port, and run on Linux for scalability and reduced downtime.

B093-, B097- and B098- console servers also offer advanced software features surpassing the requirements of even the most demanding applications. These features include network UPS tools for UPS monitoring, PowerMan for integrated PDU and UPS functions with in-session hotkey support, pattern match alerting, open access to the Linux shell for scripting, heartbeat monitoring with automatic failover, Cisco pinouts and much more.

2. Installation

2.1 Models

Each model contains a different number of network/serial/USB ports, power supply type and wireless configuration:

Model	Serial	USB	10/100 Ethernet	10/100/1000 Ethernet	Flash	Console Port	V.92 Modem	Wireless	Cellular	Power
B093-004-2E4U	4	4	-	2	4GB	-	-	-	-	External DC Power Supply
B093-008-2E4U	8	4	-	2	4GB	-	-	-	-	External DC Power Supply
B093-004-2E4U-V	4	4	-	2	4GB	-	-	4G	Multi Carrier	External DC Power Supply
B093-008-2E4U-V	8	4	-	2	4GB	-	-	4G	Multi Carrier	External DC Power Supply
B093-008-2E4U-M	8	4	-	2	4GB	-	Y	-	-	External DC Power Supply
B097-016	16	2	-	2	4GB	1	-	-	-	Dual AC
B097-048	48	2	-	2	4GB	1	-	-	-	Dual AC
B098-016	16	2	-	2	16GB	1	Y	WAP, 4G opt	-	Dual AC
B098-048	48	2	-	2	16GB	1	Y	WAP, 4G opt	-	Dual AC
B098-016-V	48	2	-	2	16GB	1	Y	WAP, 4G opt	Multi Carrier	Dual AC

2.2 Power Connection



To avoid physical and electrical hazard, please read Appendix C: Safety & Certifications.

- Unpack your console server kit, verify you have all of the accessories and ensure all items appear to be in good working order.
- If you plan to install the console server in a rack, you will need to attach the rack-mount brackets supplied with the unit. See **Appendix C: Safety & Certifications** for more information.
- Connect your console server to the network, to the serial ports of the controlled devices, and to power supply.

2.2.1 Models with Internal AC Power Supplies

Some console server models use dual universal AC power supplies with built-in auto failover (see **2.1 Models** for model listing). These power supplies accept AC input voltage between 100 and 240V AC with a frequency of 50 or 60 Hz. The total power consumption per console server is less than 30W.



Two IEC AC power inlets are located at the rear of the unit. These power inlets use conventional IEC power cords. Power cords for various regions are available at www.tripplite.com, though a North American power cord is provided by default.



To avoid electrical shock, the power cord grounding conductor must be connected to ground.

2. Installation

2.2.2 Models with External Power Supplies

Some console servers use an external 12V wall-mount power supply (see **2.1 Models** for model listing). These models include a selection of wall socket adapters for each geographic region (North America, Europe, U.K., Japan and Australia). The power supply unit's 12V DC connector plugs into the 12V DC (PWR) power jack located on the side of the unit.

- Plug in the power supply AC power cable and the DC power cable.
- Turn on the unit and confirm the Power LED (PWR) is illuminated.

2.3 Network Connection

All console server models include Ethernet ports.

Network connections are made using Cat5e patch cables (Tripp Lite N001 and N002 Series Cables, sold separately). Connect the unit's LAN port to an Ethernet network. Upon first connecting and configuring the console server to a network, you must connect a computer to the console server's primary network port.

Ensure you only connect the LAN port to an Ethernet network that supports 10/100, or 10/100/1000 (B098, B097, B093 only).

The B098 has four physical input ports which are logically presented as two ports (NET1 & NET2). Each logical port consists of a copper 10/100/1000 port and a fiber-optic small form-factor pluggable (SFP) module slot.

On all devices with logically-paired SFP and RJ45 ports, you can use only one of the two physical ports at a time: either the SFP module port or the 10/100/1000 port. The fiber-optic medium (ie, the SFP module) has priority over the copper medium (ie the RJ45 port). Only if the SFP module is not plugged in, does the RJ45 copper link becomes active. This applies regardless of the connection order. If the SFP module is plugged in after the copper medium has established a link, the copper link is disconnected and the fiber-optic medium becomes active.

For the initial configuration of the console server you must connect a computer to the console server's principal network port. This port is labeled LAN1 on B093 and NET1 on B098 and B097.

2. Installation

2.4 Serial Port Connection

Tripp Lite console servers use the RJ45 pin-out standard used by Cisco. Use straight-through RJ45 cabling to connect to Cisco, Juniper, SUN equipment and more.

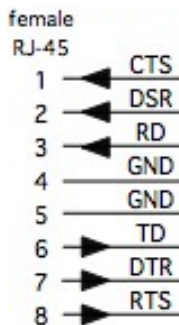
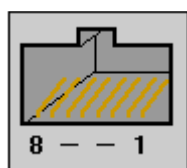

PIN	SIGNAL	DEFINITION	DIRECTION
1	CTS	Clear To Send	Input
2	DSR	Data Set Ready	Input
3	RXD	Receive Data	Input
4	GND	Signal Ground	NA
5	GND	Signal Ground	NA
6	TXD	Transmit Data	Output
7	DTR	Data Terminal Ready	Output
8	RTS	Request To Send	Output

The B098 console servers can select this pinout. This makes it easy to replace Avocent Cyclades products, and is convenient for use with rolled RJ45 cable:

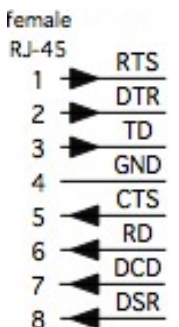
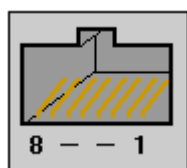

PIN	SIGNAL	DEFINITION	DIRECTION
1	CTS	Clear To Send	Input
2	DSR	Data Set Ready	Input
3	RXD	Receive Data	Input
4	GND	Signal Ground	NA
5	GND	Signal Ground	NA
6	TXD	Transmit Data	Output
7	DTR	Data Terminal Ready	Output
8	RTS	Request To Send	Output

Conventional Cat5 cabling with RJ45 jacks is used for serial connections. Before connecting the console port of an external device to the console server's serial port, confirm the device supports standard RS-232C (EIA-232).

Select console server models also have a DB9 LOCAL (Console/Modem) port.

2.5 USB Port Connection

- Tripp Lite console servers have one or more USB ports. B098 models have USB 3.0 ports. On other models these ports are mostly USB 2.0.
- Console servers ship with internal USB flash memory ranging from 2 GB to 16 GB, which can be used for extended log file storage.
- External USB devices (including USB hubs) can be plugged into any Console Server USB port.

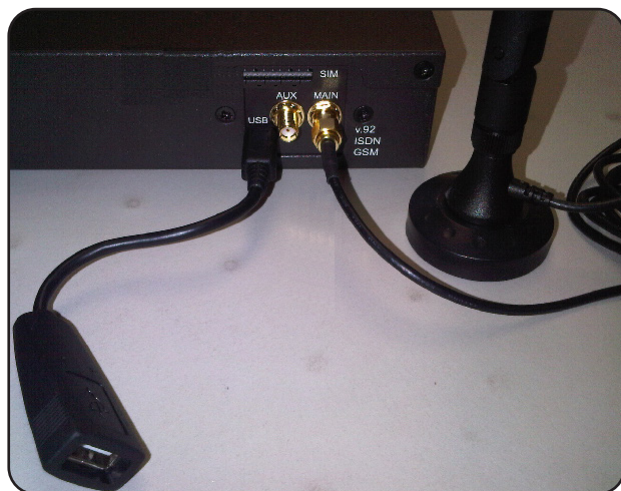

2. Installation

2.6 Fitting Cellular SIM and Antennas

The B093 -V models and the B098-016-V have internal 4G LTE cellular modems. Each cellular modem requires at least one SIM card to be installed and two external cellular antennas to be attached. For more detail:

2.6.1 B093-00X-2E4U-V Models

B093-008-2E4U-V models come with internal 4G LTE modems and dual mini-SIM card slots.

-V models work with Verizon USA by default but can be reconfigured to work with AT&T USA.

Whichever carrier you choose, their SIM card activates the data plan and must be installed before powering on the device.

On single-SIM models, slide the carrier's SIM card into the slot on the front of the device, making sure the contacts are facing upwards and the notch is pointing outwards as the card slides into place.

Dual-SIM models use a SIM cradle. The cradle holds the SIM card or cards and slides into the dual-SIM-card slot on the front of the device. The bottom slot is the default slot. If you have a dual-SIM model and only one SIM card, insert the card into the bottom slot of the SIM cradle. No matter the specific configuration, SIM cards go into the cradle with the contacts upwards and the notch inward and adjacent to the longer cradle arm.

B093 -V models come with two external 7-band cellular antennas. Screw the provided antennas on to the main Cell (M) and diversity Cell (A) SMA connectors on the rear panel. An external GPS passive antenna with magnetic base, SMA connector and 2-meter cable is available (Part #569008). It is screwed on to the GPS SMA connector on the rear panel.

2.6.2 B098-016-V Models

The B098-016-V models have a SIM card slot and three SMA cellular antenna connectors (for cellular with receive diversity and GPS).

-V models default to Verizon but are multicarrier in the United States and also work with AT&T.

Included in the kit are two cellular antennas (with one 10-foot coaxial cable and magnetic antenna screw mount base for mounting outside the rack). If cellular signal strength is an issue, higher gain and directional antennas can be sourced.



Before powering on the B098 -V:

- Screw one antenna (or antenna cable) onto the CELL (MAIN) screw mount (1) and the diversity antenna, onto the CELL (AUX) connector.

Note: If you have purchased a GPS antenna, screw it on to GPS

- Your carrier will provide you with a SIM card. Insert the card into the SIM CARD slot and it will lock into place (2)

Note: Insert SIM card with contacts facing downwards.

3. System Configuration

This chapter provides step-by-step instructions for the initial configuration of your console server and how to connect it to the Management or Operational LAN.

Notes:

- System configuration must be done by a person with Administrator access.
- For guidance on configuring large numbers of Tripp Lite console servers and/or automating provisioning, sections **15.15 Bulk Provisioning** and **15.16 Zero Touch Provisioning**.

3.1 Management Console Connection

Your console server ships configured with a default IP Address 192.168.0.1 Subnet Mask 255.255.255.0

Directly connect a computer to the console server.

Note: For initial configuration, it is recommended that the console server be directly connected to a single computer. However, if you choose to connect your LAN before completing the initial setup steps, it is important that you ensure there are no other devices on the LAN with an address of 192.168.0.1, and

the console server and the computer are on the same LAN segment, with no interposed router devices.

3.1.1 Connected Computer Setup

To configure the console server with a browser, the connected PC/workstation should have an IP address in the same range as the console server (for example, 192.168.0.100):

- To configure the IP Address of your Linux or UNIX computer, run **ifconfig**.
- For Windows PCs:
Click **Start** -> (**Settings** ->) **Control Panel** and double-click **Network Connections** (for 95/98/Me, double-click **Network**).
Right click on **Local Area Connection** and select **Properties**.
Select **Internet Protocol (TCP/IP)** and click **Properties**.

Select **Use the following IP address** and enter the following details:

IP address: **192.168.0.100**

Subnet mask: **255.255.255.0**

If you want to retain your existing IP settings for this network connection, click **Advanced** and **Add** the above as a secondary IP connection.

- If it is not convenient to change your computer network address, you can use the ARP-Ping command to reset the console server IP address. To do this from a Windows PC:

Click **Start** -> **Run** (or select **All Programs** -> **Accessories** -> **Run**).

Type **cmd** and click **OK** to bring up the command line.

Type **arp -d** to flush the ARP cache.

Type **arp -a** to view the current ARP cache (this should be empty).

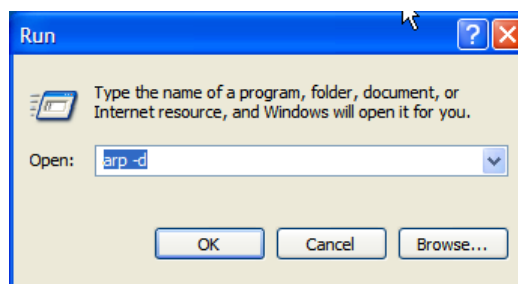

3. System Configuration

Now add a static entry to the ARP table and ping the console server to assign the IP address to the console server. In the example below, a console server has a MAC Address 00:06:67:12:DA:F1 (designated on the label on the bottom of the unit) and we are setting its IP address to 192.168.100.23. Also the computer issuing the arp command must be on the same network segment as the console server (that is, have an IP address of 192.168.100.xxx).

- Type **arp -s 192.168.100.23 00-06-67-12-DA-F1** (for UNIX, the syntax is: **arp -s 192.168.100.23 00:06:12:DA:F1**).
- Type **ping -t 192.18.100.23** to start a continuous ping to the new IP Address.
- Turn on the console server and wait for it to configure itself with the new IP address. It will start replying to the ping at this point.
- Type **arp -d** to flush the ARP cache again.

3.1.2 Browser Connection

Open a web browser on the connected PC / workstation and enter <https://192.168.0.1> . The management console supports all current versions of popular browsers (Internet Explorer, Mozilla Firefox, Google Chrome, Apple Safari, and more).

Note: Console servers are factory configured with HTTPS access enabled and HTTP access disabled.

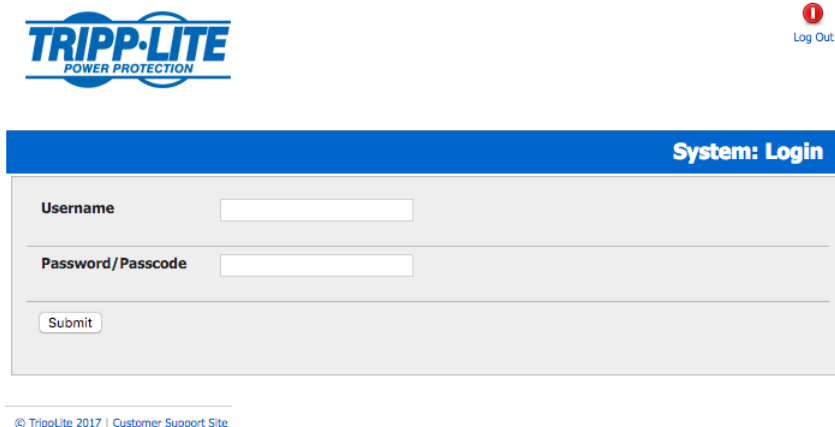

A login screen appears. Enter the default administration username **root** and administration password **default**.

Note: If you unable to connect to the management console at 192.168.0.1 or if the default Username / Password were not accepted, reset your console server (refer to **10. Nagios Integration**).

Click **Submit**. The Welcome screen listing the initial installation configuration steps will display. These steps are:

- Change default administration password (see **3.2 Administrator Setup**).
Configure the local network settings (see **3.3 Network Configuration**).
- To configure console server features:
Configure serial ports settings (see **4. Serial Port, Host, Device and User Configuration**).
Configure user port access (see **4. Serial Port, Host, Device and User Configuration**).
- If your system has a cellular modem, you will also be provided steps to configure the cellular router features:
Configure the cellular modem connection (see **5. Firewall, Failover & OOB Access**).
Allow forwarding to the cellular destination network (see **5. Firewall, Failover & OOB Access**).
Enable IP masquerading for cellular connection (see **5. Firewall, Failover & OOB Access**).

You can return to the configuration list at any time by clicking the logo in the top left corner of the screen.

3. System Configuration

3.2 Administrator Setup

3.2.1 Change Default Root System Password

For security reasons, only the Administrator user named root can initially log into your console server. Also, only users who know the root password can access and reconfigure the console server.

Since anyone who correctly guesses the root password could gain access (and the default root password is default), it is essential that you enter and confirm a new password before allow the console serve any access to, or control of, your computers and network devices.

Select **Change default administration password** from the Welcome page will take you to **Serial & Network: Users & Groups** where you can add a new confirmed Password for the user **root**.

Note: There are no restrictions on what types of characters can be used in the user password (each can contain up to 254 characters). However, only the first eight password characters are used to make the password hash.

Note: Because the console server uses flash memory, you will be given the option to save the password across firmware erases. Checking this will save the password hash in the non-volatile configuration partition, which is not erased on firmware reset. However, take care as if this password is lost, as the firmware will need to be recovered from the device.

Click **Apply**. As you have changed the password, you will be prompted to log in again. This time use the new password.

Note: If you are unsure whether your console server is operating with the most current firmware version, Firmware Upgrades are available. Refer to **11.2 Upgrade Firmware** for more information.

3.2.2 Set Up New Administrator

You should set up a new Administrator user as soon as possible for all ongoing administration functions (rather than **root**).

This Administrator can be configured in the admin group with full access privileges by selecting **Add a New User in the Serial & Network: Users & Groups** menu (refer **4.2 Add and Edit Users**).

The screenshot shows the Tripp-Lite web interface. At the top left is the Tripp-Lite logo with the tagline 'POWER PROTECTION'. To the right of the logo, system information is displayed: System Name: b093-008-2e4u-v, Model: B093-008-2E4U-V, Firmware: 4.0.0u1, Uptime: 0 days, 0 hours, 25 mins, 29 secs, and Current User: root. On the far right are navigation icons for Dashboard, Manage Devices, Backup, and Log Out. The main content area is titled 'Serial & Network: Users & Groups'. On the left, there are two expandable menu sections: 'Manage' (containing Devices, Port Logs, Host Logs, Power, and Terminal) and 'Status' (containing Port Access, Active Users, and Statistics). The main panel is titled 'Add a New user' and contains the following fields: 'Username' (with a text input field), 'Description' (with a text input field containing 'master admin'), and 'Groups' (with two radio button options: 'admin (Provides users with unlimited configuration and management privileges)' and 'pptpd (Group to allow access to the PPTP VPN server - Users in this group will have their...').

3. System Configuration

3.2.3 Name the System

Select **System: Administration**.

Enter a **System Name** and **System Description** for the console server to give it a unique ID and make it simple to identify.

System Name: b093-008-2e4u-v Model: B093-008-2E4U-V Firmware: 4.0.0u1
Uptime: 0 days, 0 hours, 28 mins, 3 secs Current User: root

Dashboard Manage Devices Backup Log Out

TRIPP-LITE
POWER PROTECTION

System: Adminis

Manage Status Serial & Network Alerts & Logging System

- » Administration
- » SSL Certificates
- » Configuration Backup
- » Firmware
- » IP
- » Date & Time
- » Dial
- » Firewall
- » Services
- » DHCP Server
- » Nagios
- » Configure Dashboard
- » Digital I/O

System Name b093-008-2e4u-v
An ID for this device.

System Description
The physical location of this device.

System Password
The system password can be changed by editing the *root* user on the [Users](#) form

MOTD Banner
 Clear this field.

Message of the day text banner to display to authenticating users.

Delayed Config Commits
 Config changes are queued, and must be explicitly applied.

Apply

Note: The System Name can contain from 1 to 64 alphanumeric characters (you can also use the special characters “-” “_” and “.”). There are no restrictions on the characters that can be used in the System Description (which can contain up to 254 characters).

The **MOTD Banner** can be used to display a “message of the day” text to users.

Click **Apply**.

Note: If you are unsure whether your console server is operating with the most current firmware version, Firmware Upgrades are available. Refer to 11.2 Upgrade Firmware for more information.

3. System Configuration

3.3 Network Configuration

Enter an IP address for the principal Ethernet (LAN/Network/Network1) port on the console server, or enable its DHCP client so that it automatically obtains an IP address from a DHCP server on the network it is to be connected to.

On the **System: IP** menu, select the **Network Interface** page, then check **DHCP** or **Static** for the Configuration Method.

If you selected **Static**, you must manually enter the new **IP Address**, **Subnet Mask**, **Gateway** and **DNS** server details. This selection automatically disables the DHCP client.

System Name: b093-008-2e4u-v Model: B093-008-2E4U-V Firmware: 4.0.0u1
Uptime: 0 days, 0 hours, 32 mins, 41 secs Current User: root

Dashboard Manage Devices Backup Log Out

System: IP

Manage Status Serial & Network Alerts & Logging System

Administration SSL Certificates Configuration Backup Firmware IP Date & Time Dial Firewall Services DHCP Server Nagios Configure Dashboard Digital I/O

Network Interface Management LAN Interface General Settings Route Settings

IP Settings: Network

Configuration Method DHCP Static
The mechanism to acquire IP settings.

IP Address
A statically assigned IP address.

Subnet Mask
A statically assigned network mask.

Gateway
Default gateway for the unit.

Primary DNS
A statically assigned primary name server.

Secondary DNS
A statically assigned secondary name server.

Media
 Auto
 100baseTx-FD
 100baseTx-HD
 100baseTx-FD
 100baseTx-HD
 10baseT-FD
 10baseT-HD

DHCP Server
Server for this interface.

IP Alias
Secondary address or comma-separated list of addresses in CIDR notation, e.g. 192.168.1.1/24.

By default, the console server LAN port auto-detects the Ethernet connection speed. However, you can use the **Media** menu to lock the Ethernet to 10 Mb/s or 100Mb/s and to Full Duplex (FD) or Half Duplex (HD).

Note: If you encounter packet loss or poor network performance with the default auto-negotiation setting, try manually setting the Ethernet Media settings on the console server and the device it is connected to. In most cases, select 100baseTx-FD (100 megabits, full duplex). Make sure both sides are set identically.

If you selected **DHCP**, the console server will search for configuration details from a DHCP server. This selection automatically disables any static address. The console server MAC address can be found on a label on the base plate

Note: In its factory default state (with no configuration method selected), the console server has its DHCP client enabled, so it automatically accepts any network IP address assigned by a DHCP server on your network. In this initial state, the console server will then respond to both its Static address (192.168.0.1) and its newly assigned DHCP address.

You may also enter a secondary address or comma-separated list of addresses in CIDR notation, e.g. 192.168.1.1/24 as an **IP Alias**.

Note: If you have changed the console server IP address, you may need to reconfigure your computer so it has an IP address that is in the same network range as this new address (as detailed in an earlier note in this section).

Click **Apply**.

You will need to reconnect the browser on the computer that is connected to the console server by entering **http://new IP address**.

3. System Configuration

3.3.1 IPv6 Configuration

By default, the console server Ethernet interfaces support IPv4. However, they can also be configured for IPv6 operation:

- On the **System: IP** menu, select **General Settings** page and check **Enable IPv6**.

The screenshot shows the Tripp-Lite web interface. At the top, the system name is b093-008-2e4u-v, model is B093-008-2E4U-V, firmware is 4.0.0u1, and uptime is 0 days, 0 hours, 34 mins, 59 secs. The current user is root. Navigation icons for Dashboard, Manage Devices, Backup, and Log Out are visible. The main menu on the left includes Manage, Status, Serial & Network, Alerts & Logging, and System. The System menu is expanded to show Administration, SSL Certificates, Configuration Backup, Firmware, IP, and Date & Time. The main content area is titled 'System: IP' and has tabs for Network Interface, Management LAN Interface, General Settings (selected), and Route Settings. Under General Settings, there are sections for Interface Aggregation (Disabled selected) and Enable IPv6 (checked). An Apply button is at the bottom.

- You will then need to configure the IPv6 parameters on each interface page.

The screenshot shows the 'IPv6 Settings: Network' configuration page. The Configuration Method is set to Static. Below this are three input fields: IPv6 Address, IPv6 Subnet Mask, and IPv6 Gateway, each with a description: 'A statically assigned IPv6 address.', 'A statically assigned IPv6 network mask.', and 'A statically assigned IPv6 gateway address.' respectively.

3.3.2 Dynamic DNS (DDNS) Configuration

With Dynamic DNS (DDNS), an advanced console server whose IP address is dynamically assigned (and may change from time to time) can be located using a fixed host or domain name.

The first step in enabling DDNS is to create an account with the supported DDNS service provider of your choice. Supported DDNS providers include:

- DyNS www.dyns.cx
- dyndns.org www.dyndns.org
- GNUDip gnudip.cheapnet.net
- ODS www.ods.org
- TZO www.tzo.com
- 3322.org (Chinese provider) www.3322.org

Upon registering with the DDNS service provider, you will select a username and password, as well as a hostname that you will use as the DNS name (to allow external access to your machine using a URL).

The Dynamic DNS service providers allow the user to choose a hostname URL and set an initial IP address to correspond to that hostname URL. Many Dynamic DNS providers offer a selection of URL hostnames available for free use with their service. However, with a paid plan, any URL hostname (including your own registered domain name) can be used.

3. System Configuration

You can now enable and configure DDNS on any of the Ethernet or cellular network connections on the console server (by default DDNS is disabled on all ports):

- Select the DDNS service provider from the dropdown **Dynamic DNS** list on the **System: IP** or **System: Dial** menu.

Dynamic DNS	
Dynamic DNS	<input checked="" type="checkbox"/> None - DDNS disabled <input type="checkbox"/> 3322 <input type="checkbox"/> dynamips <input type="checkbox"/> dyndns <input type="checkbox"/> gnudip <input type="checkbox"/> ods <input type="checkbox"/> tzo
DDNS update server	<input type="text"/>
DDNS Hostname	<input type="text"/> The Fully Qualified DNS hostname assigned to this interface.
DDNS Username	<input type="text"/> The username for the account to manage this interface.
DDNS Password	<input type="text"/> The password for the account to manage this interface.
Confirm DDNS Password	<input type="text"/> Re-enter the password for confirmation.
Maximum interval between updates	<input type="text"/> Maximum interval between updates in days. DDNS update will be sent even if the address has not changed. <i>Defaults to 25.</i>
Minimum interval between checks	<input type="text"/> Minimum interval between checks for changed addresses, in seconds. Updates will still only be sent if the address has changed. <i>Defaults to 1800.</i>
Maximum attempts per update	<input type="text"/> Number of times to attempt an update before giving up. <i>Defaults to 3.</i>
<input type="button" value="Apply"/>	

- In **DDNS Hostname**, enter the fully qualified DNS hostname for your console server e.g. your-hostname.dyndns.org.
- Enter the **DDNS Username** and **DDNS Password** for the DDNS service provider account.
- Specify the **Maximum interval between updates** (in days). A DDNS update will be sent, even if the address has not changed.
- Specify the **Minimum interval between checks** for changed addresses (in seconds). Updates will still only be sent if the address has changed.
- Specify the **Maximum attempts per update**, i.e. the number of times to attempt an update before giving up (defaults to 3).

3. System Configuration

3.4 Services and Service Access

The Administrator can access the console server, connected serial ports and managed devices by using a range of access protocols/services. For each such access:

- The particular service must first be configured and enabled to run on the console server.
- Then, access through the firewall must be enabled for each network connection.

To enable and configure a service:

- Select the **Service Settings** tab on the **System: Services** page.

Note: With firmware releases pre-3.5.3, services are enabled and configured using the **Service Access** tab on the **System: Firewall** page.

System Name: b093-008-2e4u-v Model: B093-008-2E4U-V Firmware: 4.0.0u1
Uptime: 0 days, 0 hours, 42 mins, 45 secs Current User: root

Dashboard Manage Devices Backup Log Out

System: Services

Manage Status Serial & Network Alerts & Logging System

- Administration
- SSL Certificates
- Configuration Backup
- Firmware
- IP
- Date & Time
- Dial
- Firewall
- Services
- DHCP Server
- Nagios
- Configure Dashboard
- Digital I/O

Service Settings Service Access Brute Force Protection

Here you are able to control the services running on this device. Once configured, you can control the network interfaces from which the services can be accessed via the [Service Access](#) tab.

Alternate HTTP Port	80	Alternate HTTP port to listen on. NB: The service will still be internally listening on TCP port 80 (for CMS and sdt-connector) but will be inaccessible through the firewall
Enable HTTPS Web Management	<input checked="" type="checkbox"/>	Completely enable or disable the HTTPS web management service
HTTPS Port	443	Port to listen for the HTTPS web management service
Enable Telnet command shell	<input checked="" type="checkbox"/>	Completely enable or disable the telnet service
Alternate Telnet Port	23	Alternate Telnet port to listen on. NB: The service will still be internally listening on TCP port 23 (for CMS and sdt-connector) but will be inaccessible through the firewall
Enable SSH command shell	<input checked="" type="checkbox"/>	Completely enable or disable the SSH service
SSH Port	22	Port to listen for the SSH command shell
Enable SSH DNS	<input type="checkbox"/>	Allow SSH to resolve FQDNs. Warning: this can affect connection performance on networks where DNS is not fully configured.
Nagios NRPE daemon	<input type="checkbox"/>	Click here to configure
NUT UPS monitoring daemon	<input type="checkbox"/>	Click here to configure

- Enable and configure basic services:

HTTP By default, the HTTP service is running and cannot be fully disabled. However, by default, HTTP access is disabled on all interfaces. It is recommended this access remains disabled if the console server is to be remotely accessed over the Internet.

Alternate HTTP also enables you to configure an alternate HTTP port to listen on. However, the HTTP service will continue internally listening on TCP port 80 (for CMS and sdt-connector communications), but will be inaccessible through the firewall.

HTTPS By default, the HTTPS service is running and this service is enabled on all network interfaces. It is recommended that only HTTPS access be used if the console server is to be managed over any public network (e.g. the Internet). This ensures the Administrator has secure browser access to all the menus on the console server. It also allows appropriately configured Users secure browser access to selected Manage menus. For information on certificate and user client software configuration, refer to section **9. Authentication**.

The HTTPS service can be completely disabled (or re-enabled) by checking **HTTPS Web Management** and an alternate port specified (default port is 443).

3. System Configuration

Telnet By default, the Telnet service is running. However, by default, the service is disabled on all network interfaces.

Telnet can be used to give the Administrator access to the system command line shell. While this may be suitable for a local direct connection over a management LAN, it is recommended this service be disabled if the console server is to be remotely administered. This service may also be useful for local Administrator and User access to selected serial consoles.

The **Enable telnet command shell** checkbox will completely enable or disable the telnet service. An alternate telnet port to listen on can be specified in **Alternate Telnet Port** (default port is 23).

SSH This service provides secure SSH access to the console server and attached devices. By default, the SSH service is running and enabled on all interfaces. It is recommended you choose SSH as the protocol where the Administrator connects to the console server over the Internet or any other public network. This will provide authenticated communications between the SSH client program on the remote computer and the SSH server in the console server. For more information on SSH configuration, refer to section **9. Authentication**.

The **Enable SSH command shell** checkbox will completely enable or disable this service. An alternate SSH port to listen on can be specified in **SSH command shell port** (default port is 22).

- Enable and configure other services:

TFTP/FTP If a USB flash drive or internal flash memory is detected on a console server, then checking **Enable TFTP (FTP) service** will enable this service and set up default tftp and ftp server on the USB flash. These servers are used to store config files, maintain access and transaction logs, etc. Files transferred using tftp and ftp will be stored under /var/mnt/storage.usb/tftpboot/ (or /var/mnt/storage.nvlog/tftpboot/ on B093 devices). Unchecking **Enable TFTP (FTP) service** will completely disable the TFTP (FTP) service.

DNS Relay Checking **Enable DNS Server/Relay** will enable the DNS relay feature so clients can be configured with the console server's IP for their DNS server setting. The console server will forward the DNS queries to the real DNS server.

Web Terminal Checking **Enable Web Terminal** will allow web browser access to the system command line shell via **Manage -> Terminal**.

- Specify alternate port numbers for Raw TCP, direct Telnet/SSH and unauthenticated Telnet/SSH services. The console server uses specific default ranges for the TCP/IP ports for the various access services that Users and Administrators can use to access devices attached to serial ports (refer to **4.1 Configure Serial Ports** for more information). The Administrator can also set alternate ranges for these services, and these secondary ports will then be used, in addition to the defaults.

The default TCP/IP base port address for telnet access is 2000, and the range for telnet is IP Address: Port (2000 + serial port #) i.e. 2001 – 2048. So if the Administrator were to set 8000 as a secondary base for telnet, then serial port #2 on the console server can be telnet accessed at IP Address:2002 and at IP Address:8002. The default base for SSH is 3000; for Raw TCP is 4000; and for RFC2217 it is 5000

- A number of other services can be enabled and configured indirectly from this menu by selecting **Click here to configure:**

Nagios Access to the Nagios NRPE monitoring daemons (refer to **8. Power, Environment & Digital I/O**).

NUT Access to the NUT UPS monitoring daemon (refer to **10. Nagios Integration**).

SNMP This will enable netsnmp in the console server. SNMP is disabled by default (refer to **7. Alerts, Auto-Response and Logging** and **15.5 SNMP Status Reporting**).

NTP Refer to **11. System Management**.

- Click **Apply**. As you apply your services selections, the screen will be updated with a confirmation message: **Message Changes to configuration succeeded**.

3. System Configuration

The Services Access settings can now be set to allow or block access. This specifies which (enabled) services the Administrator can use over each network interface - to connect to the console server and through the console server to attached serial and network-connected devices.

- Select the **Service Access** tab on the **System: Services** page.

Note: With firmware releases pre-3.5.3, the **Service Access** tab is found on the **System: Firewall** page.



System Name: b093-008-2e4u-v Model: B093-008-2E4U-V Firmware: 4.0.0u1
 Uptime: 0 days, 0 hours, 45 mins, 52 secs Current User: root



System: Services						
Services	Service Enabled	Service Access			Brute Force Protection	
		Network Interface	Management LAN	Dialout/Cellular	Dial-in	VPN
HTTP Web Management	Enabled	<input type="checkbox"/>	<input type="checkbox"/>	<input type="checkbox"/>	<input type="checkbox"/>	<input type="checkbox"/>
HTTPS Web Management	Enabled	<input checked="" type="checkbox"/>	<input checked="" type="checkbox"/>	<input checked="" type="checkbox"/>	<input checked="" type="checkbox"/>	<input checked="" type="checkbox"/>
Telnet command shell	Enabled	<input type="checkbox"/>	<input type="checkbox"/>	<input type="checkbox"/>	<input type="checkbox"/>	<input type="checkbox"/>
SSH command shell	Enabled	<input checked="" type="checkbox"/>	<input checked="" type="checkbox"/>	<input checked="" type="checkbox"/>	<input checked="" type="checkbox"/>	<input checked="" type="checkbox"/>
Telnet direct to serial ports	N/A	<input checked="" type="checkbox"/>	<input checked="" type="checkbox"/>	<input type="checkbox"/>	<input checked="" type="checkbox"/>	<input checked="" type="checkbox"/>
SSH direct to serial ports	N/A	<input checked="" type="checkbox"/>	<input checked="" type="checkbox"/>	<input checked="" type="checkbox"/>	<input checked="" type="checkbox"/>	<input checked="" type="checkbox"/>
RAW TCP access to serial ports	N/A	<input checked="" type="checkbox"/>	<input checked="" type="checkbox"/>	<input type="checkbox"/>	<input checked="" type="checkbox"/>	<input checked="" type="checkbox"/>
RFC-2217 access to serial ports	N/A	<input checked="" type="checkbox"/>	<input checked="" type="checkbox"/>	<input type="checkbox"/>	<input checked="" type="checkbox"/>	<input checked="" type="checkbox"/>
Unauthenticated telnet access to serial ports	N/A	<input checked="" type="checkbox"/>	<input checked="" type="checkbox"/>	<input type="checkbox"/>	<input checked="" type="checkbox"/>	<input checked="" type="checkbox"/>
Unauthenticated SSH access to serial ports	N/A	<input checked="" type="checkbox"/>	<input checked="" type="checkbox"/>	<input type="checkbox"/>	<input checked="" type="checkbox"/>	<input checked="" type="checkbox"/>
Nagios NRPE daemon	Disabled	<input checked="" type="checkbox"/>	<input checked="" type="checkbox"/>	<input type="checkbox"/>	<input checked="" type="checkbox"/>	<input checked="" type="checkbox"/>

- This will display the services currently enabled for the console server’s network interfaces. Depending on the particular console server model, the interfaces displayed may include:
 - Network interface (for the principal Ethernet connection)
 - Management LAN / OOB Failover (second Ethernet connections)
 - Dial-out/Cellular (V90 and 3G modem)
 - Dial-in (internal or external V90 modem)
 - VPN (IPsec or Open VPN connection over any network interface)
 - Check/uncheck for each network which service access is to be enabled /disabled.

3. System Configuration

- In the example shown below, local administrators on local Management LAN have direct telnet access to the console server (and attached serial ports), while remote administrators using dial-in or cellular have no such telnet access (unless they set up a VPN).

Service Settings			Service Access			
Services	Service Enabled	Network Interface	Management LAN	Dialout/Cellular	Dial-in	VPN
HTTP Web Management	Enabled	<input type="checkbox"/>	<input type="checkbox"/>	<input type="checkbox"/>	<input type="checkbox"/>	<input type="checkbox"/>
HTTPS Web Management	Enabled	<input checked="" type="checkbox"/>	<input checked="" type="checkbox"/>	<input checked="" type="checkbox"/>	<input checked="" type="checkbox"/>	<input checked="" type="checkbox"/>
Telnet command shell	Enabled	<input type="checkbox"/>	<input checked="" type="checkbox"/>	<input type="checkbox"/>	<input type="checkbox"/>	<input checked="" type="checkbox"/>
SSH command shell	Enabled	<input checked="" type="checkbox"/>	<input checked="" type="checkbox"/>	<input checked="" type="checkbox"/>	<input checked="" type="checkbox"/>	<input checked="" type="checkbox"/>
Telnet direct to serial ports	N/A	<input type="checkbox"/>	<input checked="" type="checkbox"/>	<input type="checkbox"/>	<input type="checkbox"/>	<input checked="" type="checkbox"/>
SSH direct to serial ports	N/A	<input checked="" type="checkbox"/>	<input checked="" type="checkbox"/>	<input checked="" type="checkbox"/>	<input checked="" type="checkbox"/>	<input checked="" type="checkbox"/>

- Respond to ICMP echoes** (i.e. ping) Service access options can be configured at this stage. This allows the console server to respond to incoming ICMP echo requests. Ping is enabled by default. However for security reasons, this service should generally be disabled post-initial configuration.
- You can also configure to allow serial port devices to be accessed from assigned network interfaces using Raw TCP, direct Telnet/SSH, unauthenticated Telnet/SSH services, etc.
- Click **Apply** to apply your services access selections.

3.4.1 Brute Force Protection

Brute force protection (Micro Fail2ban) temporarily blocks source IPs that show malicious signs, such as too many password failures. This may help mitigate scenarios where the Tripp Lite device's network services are exposed to an untrusted network such as the public WAN, and scripted attacks or software worms are attempting to guess (brute force) user credentials and gain unauthorized access.

Service Settings Service Access **Brute Force Protection**

Brute force protection (Fail2ban) temporarily blocks source IPs that show malicious signs, such as too many password failures.

Protected Services

Services	Service Enabled	Protection Enabled
SSH command shell	Enabled	<input checked="" type="checkbox"/>
HTTP/HTTPS Web Management	Enabled	<input type="checkbox"/>

Attempt limit
Number of login attempts per minute before an IP address ban is triggered. Default is 3.

Ban timeout
Duration of a triggered IP ban, in seconds. Default is 60 seconds.

Active Bans

There are currently no active IP bans

Brute Force Protection may be enabled for the listed services. Once protection is enabled, three or more failed connection attempts within 60 seconds from a specific source IP trigger it to be banned from connecting for the next 60 seconds. Active Bans are also listed and may be refreshed by reloading the page.

Note: When a Tripp Lite device is running on an untrusted network, it is recommended that a variety of strategies be used to lock down remote access. This includes strong passwords (or even better, SSH public key authentication), VPN, and using Firewall Rules to whitelist remote access from trusted source networks only. Refer to the Knowledge Base for details.

3. System Configuration

3.5 Communications Software

You have configured access protocols for the Administrator client to use when connecting to the console server. User clients (who you may set up later) will also use these protocols when accessing console server serial attached devices and network attached hosts. Therefore, you will need to have appropriate communications software tools set up on the Administrator (and User) client's computer. Tripp Lite provides the SDT Connector as the recommended client software tool. However, other generic tools such as PuTTY and SSHTerm may be used.

3.5.1 SDT Connector

SDT Connector is a lightweight tool that enables Users and Administrators to securely access the Console server and the various computers, network devices and devices that may be serially- or network- connected to the console server.

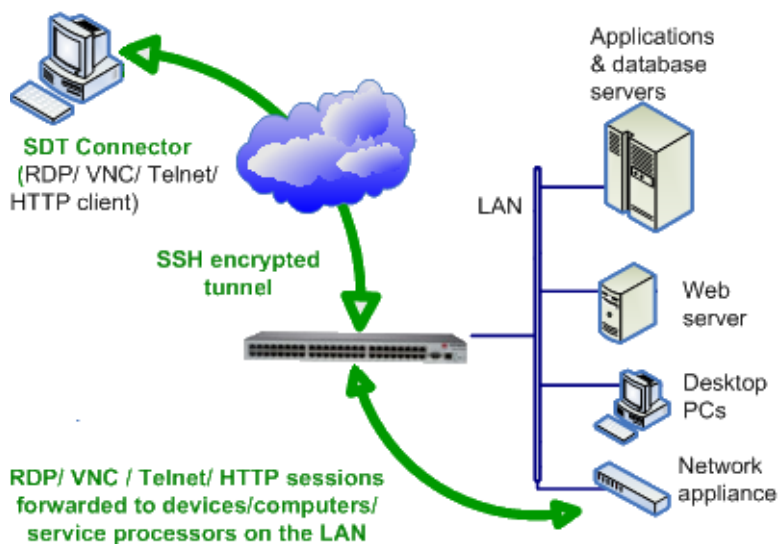

SDT Connector is a Java client program that couples the trusted SSH tunneling protocol with popular access tools such as telnet, SSH, HTTP, HTTPS, VNC, RDP to provide point-and-click secure remote management access to all systems and devices being managed.

Information on using SDT Connector for browser access to the console server's management console, telnet/SSH access to the console server command line, and TCP/UDP connecting to hosts that are network-connected to the console server can be found in section **6. Secure Tunneling**.

SDT Connector can be installed on Windows PCs, Mac OS and on most Linux, UNIX and Solaris systems.

3. System Configuration

3.5.2 PuTTY

Communications packages like PuTTY can also be used to connect to the console server command line (and to connect serially attached devices, refer to **4. Serial Port, Host, Device and User Configuration**). PuTTY is a freeware implementation of telnet and SSH for Win32 and UNIX platforms. It runs as an executable application without needing to be installed onto your system. PuTTY (the telnet and SSH client itself) can be downloaded at <http://www.tucows.com/preview/195286.html>.

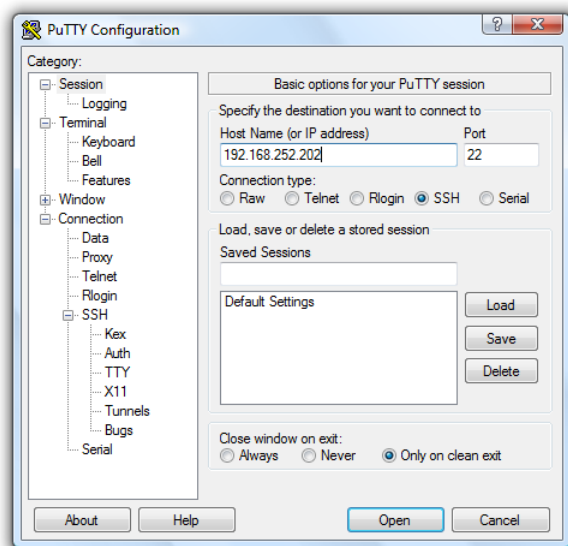

To use PuTTY for an SSH terminal session from a Windows client, enter the console server’s IP address as the “Host Name (or IP address)”.

To access the console server command line, select **SSH** as the protocol, and use the default IP Port 22.

Click **Open**. You will be presented with the console server login prompt. You may also receive a security alert stating the host’s key is not cached. If this is the case, choose **yes** to continue.

Using the telnet protocol is similarly simple, except you use the default port 23.

3.5.3 SSHTerm

Another common communications package that may be useful is SSHTerm, an open source package that can be downloaded from <http://sourceforge.net/projects/sshtools>:

To use SSHTerm for an SSH terminal session from a Windows Client, simply select the **File** option and click on **New Connection**.

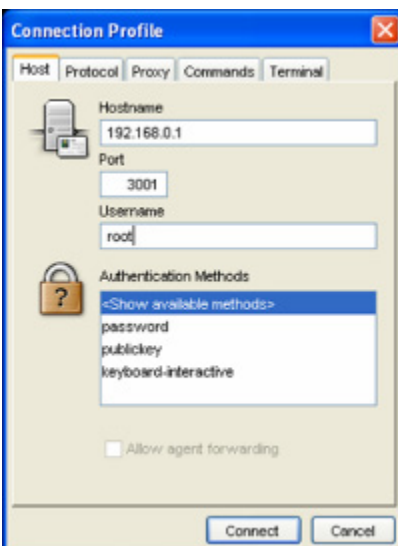

3. System Configuration

A new Connection Profile dialog box will appear where you can type in the host name or IP address (for the console server unit) and the TCP port that the SSH session will use (port 22). Type in your username, choose password authentication and click **Connect**.

You may receive a message about the host key fingerprint, and you will need to select **Yes** or **Always** to continue.

The next step is password authentication, where a prompt will appear asking for your username and password from the remote system to log on to the console server.

3.6 Management Network Configuration

Select console servers have additional network ports that can be configured to provide management LAN access and/or failover or out-of-band access.

3.6.1 Enable the Management LAN

The console servers can be configured so the second Ethernet port provides a management LAN gateway. The gateway has firewall, router and DHCP server features. However, you will need to connect an external LAN switch to Network/LAN 2 to attach hosts to this management LAN:

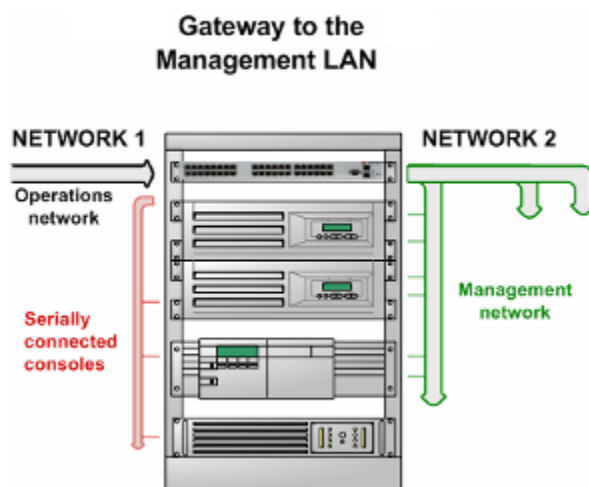

Note: The second Ethernet port (Network/LAN2) on the console server can be configured as either a Management LAN gateway port or an OOB/Failover port—it cannot be both. As such, ensure you did not allocate Network/LAN 2 as the Failover Interface when you configured the principal Network connection on the System: IP menu.

3. System Configuration

The Management LAN features are all disabled by default. To configure the Management LAN gateway:

- Select the **Management LAN Interface** page on the **System: IP** menu and uncheck **Disable**.
- Configure the **IP Address** and **Subnet Mask** for the Management LAN (but leave the **DNS** fields blank).
- Click **Apply**.

The screenshot shows the Tripp-Lite web interface. At the top left is the Tripp-Lite logo. To the right, system information is displayed: System Name: b093-008-2e4u-v, Model: B093-008-2E4U-V, Firmware: 4.0.0u1, Uptime: 0 days, 0 hours, 54 mins, 53 secs, Current User: root. Navigation icons for Dashboard, Manage Devices, Backup, and Log Out are visible.

The main content area is titled "System: IP" and contains a navigation menu on the left with categories: Manage, Status, Serial & Network, Alerts & Logging, and System. The "System" category is expanded to show sub-items like Administration, SSL Certificates, Configuration Backup, Firmware, IP, Date & Time, Dial, Firewall, Services, DHCP Server, Nagios, Configure Dashboard, and Digital I/O.

The main configuration area shows a message: "Changes to configuration succeeded." Below this are tabs for "Network Interface", "Management LAN Interface" (which is selected), "General Settings", and "Route Settings".

Under the "Management LAN Interface" tab, there is a "Disable" checkbox which is currently unchecked. Below this is a section titled "IP Settings: Management LAN" with the following fields:

- Configuration Method:** Radio buttons for DHCP and Static. "Static" is selected.
- IP Address:** A text input field.
- Subnet Mask:** A text input field.
- Gateway:** A text input field.
- Primary DNS:** A text input field.
- Secondary DNS:** A text input field.
- Media:** A dropdown menu set to "Auto".
- DHCP Server:** A dropdown menu set to "Disabled".
- IP Alias:** A text input field.

The management gateway function is now enabled with default firewall and router rules. By default, these rules are configured so the Management LAN can only be accessed by SSH port forwarding. This ensures the remote and local connections to managed devices on the Management LAN are secure. The LAN ports can also be configured in bridged or bonded mode (as described later in this section) or they can be manually configured from the command line.

3. System Configuration

3.6.2 Configure the DHCP Server

All Tripp Lite devices host a DHCP server. However, this setting is disabled by default. The DHCP server enables the automatic distribution of IP addresses to devices on the Management LAN that are running DHCP clients. To enable the DHCP server:

- On the **System: IP** menu, select the **Management LAN** page and click the **Disabled** label in the **DHCP Server** field (or go directly to the **System: DHCP Server** menu).
- Check **Enable DHCP Server**.

System Name: b093-008-2e4u-v Model: B093-008-2E4U-V Firmware: 4.0.0u1
Uptime: 0 days, 1 hours, 2 mins, 8 secs Current User: root

Dashboard Manage Devices Backup Log Out

System: DHCP Server

Network Interface Management LAN Interface

Network DHCP Server Settings (Subnet 10.5.0.0 / 255.255.255.0)

DHCP Server Enable DHCP Server

Gateway The Default Gateway to assign.

Use interface address as gateway Use this interface as the DHCP Gateway.

Primary DNS The primary DNS to assign.

Secondary DNS The secondary DNS to assign.

Use this interface address as the DNS server Use the built-in DNS relay for DNS lookups.
The DNS service must be enabled on the [Services](#) page

Domain Name The Domain Name to assign.

Default Lease The Default Lease Time in Seconds.

Maximum Lease The Maximum Lease Time in Seconds.

Apply

Dynamic Address Allocation Pools

Pool Start	Pool End
No address pools currently allocated.	

Add

Reserved Addresses

IP Address	Host Name	HW Address
No addresses currently reserved.		

- Enter the **Gateway** address that is to be issued to the DHCP clients. If this field is left blank, the console server's IP address will be used.
- Enter the **Primary DNS** and **Secondary DNS** address to issue the DHCP clients. If this field is left blank, the console server's IP address is used. Leave this field blank for automatic DNS server assignment.
- Optionally enter a **Domain Name** suffix to issue DHCP clients.
- Enter the **Default Lease** time and **Maximum Lease** time (in seconds). The lease time is the time that a dynamically assigned IP address is valid before the client must request it again.
- Click **Apply**.

3. System Configuration

The DHCP server will sequentially issue IP addresses from a specified address pool(s):

- Click **Add** in the **Dynamic Address Allocation Pools** field.
- Enter the **DHCP Pool Start Address** and **End Address**, then click **Apply**.

The screenshot shows a configuration window titled "Network Interface". Inside, there is a section titled "Dynamically Allocated Pool". It contains two input fields: "DHCP Pool Start Address" with the value "100" and "DHCP Pool End Address" with the value "150". Below each input field is a descriptive text: "The first address in the pool to use for DHCP." and "The last address in the pool to use for DHCP." respectively. At the bottom left of the section is an "Apply" button.

The DHCP server also supports pre-assigning IP addresses to be allocated only to specific MAC addresses and reserving IP addresses to be used by connected hosts with fixed IP addresses. To reserve IP addresses for a particular host:

- Click **Add** in the **Reserved Addresses** field.
- Enter the **Hostname**, the **Hardware Address** (MAC) and the **Statically Reserved IP** address for the DHCP client, then click **Apply**.

The screenshot shows a configuration window titled "Network Interface". Inside, there is a section titled "Statically Reserved Address". It contains three input fields: "Host Name", "Statically Reserved IP", and "Hardware Address". Below each input field is a descriptive text: "The name to identify this host by.", "IP Address reserved for specific host.", and "MAC Address to reserve IP for." respectively. At the bottom left of the section is an "Apply" button.

When DHCP has initially allocated hosts' addresses, it is recommended to copy these into the pre-assigned list so the same IP address will be reallocated in the event of a reboot.

3. System Configuration

3.6.3 Select Failover or Broadband OOB

The B093 and B098 console servers provide a failover option. In the event a problem arises while using the main LAN connection for accessing the console server, an alternate access path is automatically used.

By default, the failover is not enabled. To enable:

- Select the **Network** page on the **System: IP** menu.
- Now select the **Failover Interface** to be used in the event of an outage on the main network. This can be:
 - o A second Ethernet connection on the console server.
 - o The console server's internal modem.
 - o An external modem device connected to the console server.

Failover Interface	<input type="text" value="Management LAN (lan)"/>	A device to fail to in case of outage. Devices must be configured and enabled for failover to work.
Dormant Failover Interface	<input type="checkbox"/>	If the failover interface should stay active at all times, only being routed through in failure situations.
Primary Probe Address	<input type="text" value="192.168.254.254"/>	The address of the first peer to probe for connectivity detection.
Secondary Probe Address	<input type="text"/>	The address of the second peer to probe for connectivity detection.

- Click **Apply**. You have selected the failover method. However, it is not active until you have specified the external sites to be probed to trigger failover and set up the failover ports themselves. For more information, refer to section **5. Firewall, Failover and OOB Access**.



System Name: b093-008-2e4u-v Model: B093-008-2E4U-V Firmware: 4.0.0u1
Uptime: 1 days, 17 hours, 37 mins, 22 secs Current User: root



System: IP

- Manage
- Status
- Serial & Network
- Alerts & Logging
- System
 - Administration
 - SSL Certificates
 - Configuration Backup
 - Firmware
 - IP
 - Date & Time
 - Dial
 - Firewall
 - Services
 - DHCP Server
 - Nagios
 - Configure Dashboard
 - Digital I/O

Network Interface | **Management LAN Interface** | General Settings | Route Settings

Disable Deactivate this network interface.

IP Settings: Management LAN - Currently Failover for Network Interface

Configuration Method DHCP Static
The mechanism to acquire IP settings.

IP Address
A statically assigned IP address.

Subnet Mask
A statically assigned network mask.

Note: The second Ethernet port on the console server can be configured as either a Management LAN gateway port or it can be configured as an OOB/Failover port, but not both. Ensure you did not configure this port as the Management LAN on the System: IP menu.

3. System Configuration

3.6.4 Aggregating the Network Ports

By default, the console server's Management LAN network ports can only be accessed using SSH tunneling /port forwarding or by establishing an IPsec VPN tunnel to the console server.

However, all wired network ports on the console servers can be aggregated by being bridged or bonded.

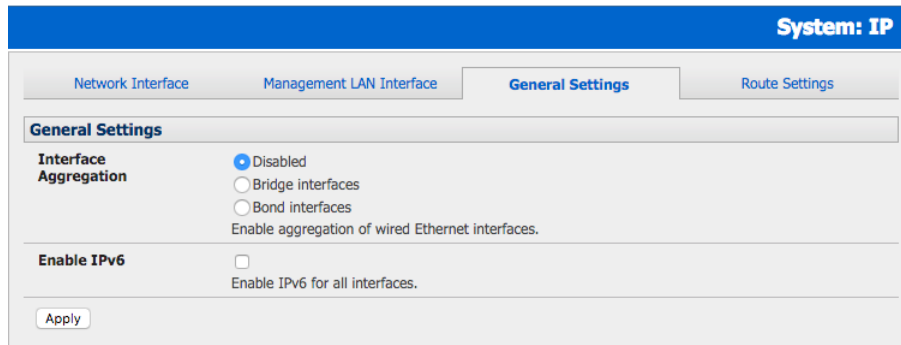

The screenshot shows the 'System: IP' configuration interface. At the top, there are four tabs: 'Network Interface', 'Management LAN Interface', 'General Settings' (which is selected), and 'Route Settings'. Below the tabs, the 'General Settings' section is visible. It contains two main settings: 'Interface Aggregation' and 'Enable IPv6'. Under 'Interface Aggregation', there are three radio button options: 'Disabled' (which is selected), 'Bridge interfaces', and 'Bond interfaces'. Below these options is the text 'Enable aggregation of wired Ethernet interfaces.' Under 'Enable IPv6', there is an unchecked checkbox and the text 'Enable IPv6 for all interfaces.' At the bottom left of the settings area, there is an 'Apply' button.

By default, **Interface Aggregation** is disabled on the System: IP General Settings menu.

Select **Bridge Interfaces** or **Bond Interfaces**

- When bridging is enabled, network traffic is forwarded across all Ethernet ports with no firewall restrictions. All the Ethernet ports are transparently connected at the data link layer (layer 2), so they do retain their unique MAC addresses.
- With bonding, the network traffic is carried between the ports but they present with one MAC address.
- Both modes remove all **Management LAN Interface** and **Out-of-Band/Failover Interface** functions and disable the **DHCP Server**.

In aggregation mode, all Ethernet ports are configured collectively using the **Network Interface** menu.

3. System Configuration

3.6.5 Static Routes

Firmware 3.4 and later support static routes, which provide a quick way to route data from one subnet to a different subnet. You can hard code a path that specifies to the console server/router to get to a certain subnet by using a certain path. This may be useful for remotely accessing various subnets at a remote site when being accessed using the cellular OOB connection.

Route Settings	
Route Name	<input type="text" value="New Route"/> <small>Meaningful name for the Route</small>
Destination Network/Host	<input type="text" value="4.5.0.0"/> <small>The destination network/host that the route provides access to.</small>
Destination netmask	<input type="text" value="16"/> <small>The netmask of the destination network. A number in the range 0-32</small>
Route Gateway	<input type="text"/> <small>The IP address of a router that will route packets to the destination network</small>
Interface	<input type="text" value="Network Interface"/> <small>An interface to associate with the route. Can be left as None.</small>
Metric	<input type="text" value="0"/> <small>The route metric, which represents the cost of routing packets via this route. Lower metric routes will be used in preference to higher metric routes</small>
<input type="button" value="Apply"/>	

To add to the static route to the system's route table:

- Select the **Route Settings** tab on the **System: IP General Settings** menu.
- Enter a meaningful **Route Name** for the route.
- In the **Destination Network/Host** field, enter the IP address of the destination network/host that the route provides access to.
- Enter a value in the **Destination netmask** field that identifies the destination network or host. Any number between 0 and 32 can be used. A subnet mask of 32 identifies a host route.
- Enter **Route Gateway** with the IP address of a router that will route packets to the destination network. This field may be left blank.
- Select the **Interface** to use to reach the destination. This field may be left as **None**.
- Enter a value in the **Metric** field that represents the metric of this connection. This generally has to be set only if two or more routes conflict or have overlapping targets. Any number equal to or greater than 0.
- Click **Apply**.

Note: The route details page provides a list of network interfaces and modems to which a route can be bound. In the case of a modem, the route will be attached to any dial-up session, which is established via that device. A route can be specified with a gateway, an interface or both. If the specified interface is not active for whatever reason, then the routes configured for that interface will not be active.

3.7 Configuration over DHCP (ZTP)

Configuration-over-DHCP is available for all Tripp Lite console managers running firmware release 3.16 or later. With this feature, Tripp Lite devices can be provisioned during their initial boot from a DHCP server. Provisioning on untrusted networks can be facilitated by providing keys on a USB flash drive.

Preparation

The typical steps for configuration over a trusted network are:

- Manually configure a same-model Tripp Lite device.
- Save its configuration as a backup (.opg) file.
- Select **System > Configuration Backup > Remote Backup**.
- Click **Save Backup**.

3. System Configuration

A backup configuration file — **model-name_iso-format-date_config.opg** — is downloaded from the Tripp Lite device to the local system.

Alternately, you can save the configuration as an xml file:

- Select System > Configuration Backup > XML Configuration.

An editable field containing the configuration file in XML format is presented.

- Click into the field to make it active.
- If you are running any browser on Windows or Linux, right-click and choose **Select All** from the contextual menu or press Control-A. Then, right-click and choose **Copy** from the contextual menu or press Control-C.
- If you are using any browser on Mac OS, choose **Edit > Select All** or press **Command-A**. Then choose **Edit > Copy** or press **Command-C**.
- In your preferred text-editor, create a new empty document, paste the copied data into the empty document and save the file. Whatever file-name you choose, it must include the **.xml** filename suffix.
- Copy the saved .opg or .xml file to a public-facing directory on a file server serving at least one of the following protocols: HTTPS, HTTP, FTP or TFTP (only HTTPS can be used if the connection between the file server and a to-be-configured Tripp Lite device travels over an untrusted network).
- Configure your DHCP server to include a vendor-specific option for Tripp Lite devices (this will be performed in a DHCP server-specific way). The vendor-specific option should be set to a string containing the URL of the published **.opg** or **.xml** file in the step above. The option string must not exceed 250 characters and it must end in either .opg or .xml.
- Connect a new Tripp Lite device (either factory-reset or Config-Erased) to the network and apply power.

Note: It may take up to 5 minutes for the device to find the .opg or .xml file (via DHCP), download, install and then reboot.

Example ISC DHCP (dhcpd) Server Configuration

The following is an example DHCP server configuration fragment for serving an .opg configuration image via the ISC DHCP server, dhcpd:

```
option space tripp-lite code width 1 length width 1;
option tripp-lite.config-url code 1 = text;

class " tripp-lite -config-over-dhcp-test" {
  match if option vendor-class-identifier ~~ " ^Tripp Lite/";
  vendor-option-space tripp-lite;
  option tripp-lite.config-url "https://example.com/tripp-lite/${class}.opg";
}
```

Setup When the LAN is Untrusted

If the connection between the file server and a to-be-configured Tripp Lite device includes an untrusted network, a two-handed approach can mitigate the issue.

Note: This approach adds two physical steps where trust can be difficult, if not impossible, to establish completely. First, the custody chain from the creation of the data-carrying USB flash drive to its deployment. Second, the hands connecting the USB flash drive to the Tripp Lite device.

- Generate an X.509 certificate for the Tripp Lite device.
- Concatenate the certificate and its private key into a single file named client.pem.
- Copy client.pem onto a USB flash drive.
- Set up an HTTPS server such that access to the .opg or .xml file is restricted to clients that can provide the X.509 client certificate generated above.
- Put a copy of the CA cert that signed the HTTP server's certificate — ca-bundle.crt — onto the USB flash drive bearing client.pem.
- Insert the USB flash drive into the Tripp Lite device before attaching power or network.
- Continue the procedure from 'Copy the saved .opg or .xml file to a public-facing directory on a file server' above using the HTTPS protocol between the client and server.

3. System Configuration

Prepare a USB Drive and Create the X.509 Certificate and Private Key

- Generate the CA certificate so the client and server Certificate Signing Requests (CSRs) can be signed.

```
# cp /etc/ssl/openssl.cnf .
# mkdir -p exampleCA/newcerts
# echo 00 > exampleCA/serial
# echo 00 > exampleCA/crlnumber
# touch exampleCA/index.txt
# openssl genrsa -out ca.key 8192
# openssl req -new -x509 -days 3650 -key ca.key -out demoCA/cacert.pem \
  -subj /CN=ExampleCA
# cp demoCA/cacert.pem ca-bundle.crt
```

Note: This procedure generates a certificate called *ExampleCA*, but any allowed certificate name can be used. Also, this procedure uses `openssl ca`. If your organization has an enterprise-wide, secure CA generation process, that should be used instead.

- Generate the server certificate.

```
# openssl genrsa -out server.key 4096
# openssl req -new -key server.key -out server.csr -subj /CN=demo.example.com
# openssl ca -days 365 -in server.csr -out server.crt \
  -keyfile ca.key -policy policy_anything -batch -notext
```

Note: The hostname or IP address must be the same string as will be used in the serving URL. In the example above, the hostname is *demo.example.com*.

- Generate the client certificate.

```
# openssl genrsa -out client.key 4096
# openssl req -new -key client.key -out client.csr -subj /CN=ExampleClient
# openssl ca -days 365 -in client.csr -out client.crt \
  -keyfile ca.key -policy policy_anything -batch -notext
# cat client.key client.crt > client.pem
```

- Format a USB flash drive as a single FAT32 volume.
- Move the **client.pem** and **ca-bundle.crt** files onto the flash drive's root directory.

4. Serial Port, Host, Device and User Configuration

The console server enables access and control of serially attached devices and network-attached devices (hosts). The Administrator must configure access privileges for each of these devices, and specify the services that can be used to control the devices. The Administrator can also set up new users and specify each user's individual access and control privileges.

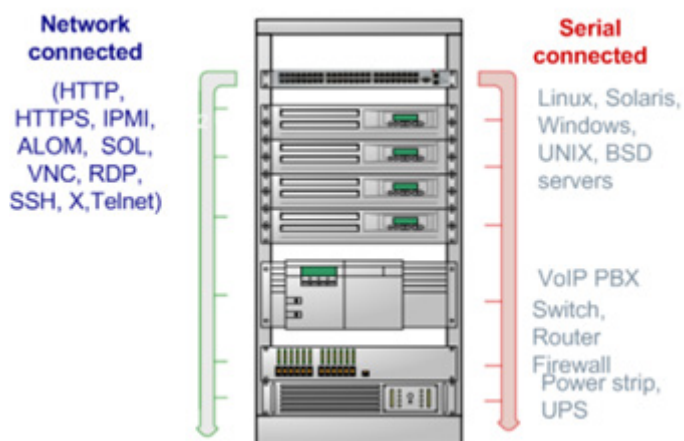

4.1 Configure Serial Ports

The first step in configuring a serial port is to set the **Common Settings**, such as the protocols and the RS-232 parameters that are to be used for the data connection to that port (e.g. baud rate).

Then you select what mode the port is to operate in. Each port can be set to support one of these operating modes:

- i. **Disabled mode** is the default. The serial port is inactive.
- ii. **Console Server mode** enables general access to serial console port on the serially attached devices.
- iii. **Device mode** sets the serial port up to communicate with an intelligent serial controlled PDU, UPS or Environmental Monitor Devices (EMD).
- iv. **SDT mode** enables graphical console access (with RDP, VNC, HTTPS etc.) to hosts that are serially connected.
- v. **Terminal Server mode** sets the serial port to await an incoming terminal login session.
- vi. **Serial Bridge mode** enables the transparent interconnection of two serial port devices over a network.

Serial & Network: Serial Port						
Port #	Label	Mode	Ports 1-8	Ports 9-16	Parameters	Flow Control
				Logging Level		
1	IP Power	RPC (Unconfigured)		0	19200-8-N-1	None Edit
2	Cisco 2501	Console (Telnet, SSH)		2	9600-8-N-1	None Edit
3	Cisco 2900	Console (SSH)		2	9600-8-N-1	None Edit
4	8 Port Server Tech PDU	RPC (Unconfigured)		2	9600-8-N-1	None Edit
5	TrippLite 450 UPS	UPS (Unconfigured)		0	9600-8-N-1	None Edit
6	TrippLite 450 UPS	UPS (Unconfigured)		0	9600-8-N-1	None Edit
7	IM4248 Console	Console (SSH)		2	115200-8-N-1	None Edit
8	Loopback connector	Console (Telnet, SSH, Raw TCP)		1	9600-8-N-1	None Edit

Select **Serial & Network: Serial Port** to see details of the serial ports currently set up.

By default, each serial port is set in **Console Server** mode. To reconfigure the port, click **Edit**.

When you have reconfigured the common settings (see **4.1.1 Common Settings**) and the mode (see sections **4.1.2 - 4.1.6**) for each port, set up any remote syslog (see **4.1.7 Syslog**), then click **Apply**.

Note: If you wish to set the same protocol options for multiple serial ports at once, click *Edit Multiple Ports* and select which ports you wish to configure as a group.

4. Serial Port, Host, Device and User Configuration

If the console server has been configured with distributed Nagios monitoring enabled, then you will also be presented with **Nagios Settings** options to enable assigned services on the Host to be monitored (see section **10. Nagios Integration** for more information).

4.1.1 Common Settings

There are a number of common settings for each serial port. These are independent of the mode in which the port is being used. These serial port parameters must be set so they match the serial port parameters on the device you attach to that port:

Common Settings for Port 1	
Label	Port 1 <input type="text"/> <small>The serial ports unique identifier.</small>
Disabled	<input checked="" type="radio"/> Disable this serial port.
Local Console Mode	<input type="radio"/> Use this serial port for console or dial-in access. Warning: This will override all other port settings
Baud Rate	9600 <small>The serial ports speed.</small>
Data Bits	8 <small>The number of data bits to use.</small>
Parity	None <small>The serial ports parity.</small>
Stop Bits	1 <small>The number of stop bits to use.</small>
Flow Control	None <small>The flow control method.</small>
Signaling Protocol	RS232 <small>The electrical signaling on this serial port. Consult your manual to determine which protocols are supported for this port.</small>

- Specify a label for the port.
- Select the appropriate **Baud Rate**, **Parity**, **Data Bits**, **Stop Bits** and **Flow Control** for each port.
- Set the **Signaling Protocol**. This menu item only presents in ports with RS422/485 options. The options available are RS-232, RS-422, RS-485 and RS-485 Echo mode.
- Set the **Port Pin-Out**. This menu item is only for ports where pin-out for each RJ45 serial port can be set as either X2 (Cisco Straight) or X1 (Cisco Rolled).
- Before proceeding with further serial port configuration, you should connect the ports to the serial devices they will be controlling and ensure they have matching settings.

4.1.2 Console Server Mode

- Select **Console Server Mode** to enable remote management access to the serial console that is attached to this serial port:

Console Server Settings	
Console Server Mode	<input checked="" type="radio"/> Enable remote network access to the console at this serial port.
Logging Level	level 0 - Disabled <small>Specify the detail of data to log. In this context: - output is the data transmitted from the console server to the connected device. - input is the data received by the console server from the connected device.</small>
Telnet	<input checked="" type="checkbox"/> Enable Telnet access.
SSH	<input checked="" type="checkbox"/> Enable SSH access.
Raw TCP	<input type="checkbox"/> Enable raw TCP access.
RFC 2217	<input type="checkbox"/> Enable RFC 2217 access.
Unauthenticated Telnet	<input type="checkbox"/> Enable Telnet access without requiring the user to provide credentials.
Web Terminal	<input type="checkbox"/> Enable web browser access via <i>Manage -> Devices -> Serial</i> .
Network Interface IP Alias	1.2.3.4/24 <small>Comma-separated list of IP addresses on which only this port is available, in CIDR notation, e.g. 192.168.1.1/24.</small>
Management LAN IP Alias	<input type="text"/> <small>Comma-separated list of IP addresses on which only this port is available, in CIDR notation, e.g. 192.168.1.1/24.</small>
Out-of-Band/Failover IP Alias	<input type="text"/> <small>Comma-separated list of IP addresses on which only this port is available, in CIDR notation, e.g. 192.168.1.1/24.</small>



4. Serial Port, Host, Device and User Configuration

Logging Level This specifies the level of information to be logged and monitored (refer to 7. Alerts and Logging).

Telnet

When the telnet service is enabled on the console server, a telnet client on a User's or Administrator's computer can connect to a serial device attached to this serial port on the console server. The telnet communications are unencrypted so this protocol is generally recommended only for local or VPN tunneled connections.

With Win2000/XP/NT, you can run telnet from the command prompt (cmd.exe). Windows Vista and later ships with a telnet client but it is not enabled by default. You can install it by following the simple steps below.

- o Click the **Start button** , click **Control Panel**, click **Programs**, and then click **Turn Windows Features On or Off** . If you are prompted for an administrator password or confirmation, type the password or provide confirmation.
- o In the **Windows Features** dialog box, select the **Telnet Client** check box.
- o Click **OK**. The installation might take several minutes.

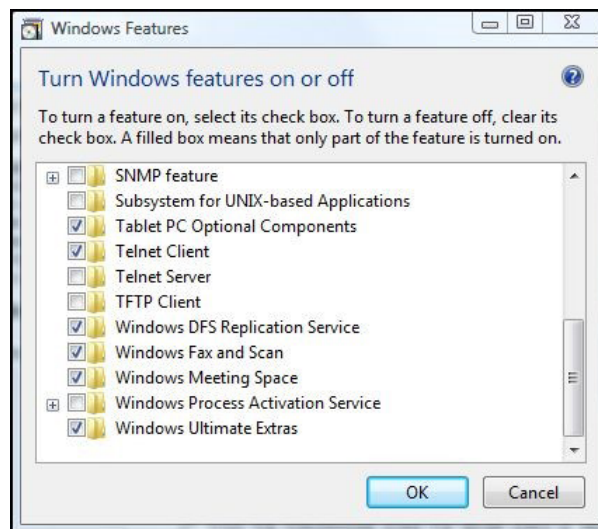

If remote communications are being tunneled with SDT Connector, then telnet can be used for securely accessing these attached devices.

Note: In Console Server mode, Users and Administrators can use SDT Connector to set up secure telnet connections that are SSH tunneled from their client computers to the serial port on the console server. The SDT Connector can be installed on Windows PCs and on most Linux platforms. It enables secure telnet connections to be selected with a simple point-and-click.

To use SDT Connector to access consoles on the console server serial ports, configure the SDT Connector with the console server as a gateway, then as a host. Then enable telnet service on Port (2000 + serial port #) i.e. 2001–2048. Refer to **6. SSH Tunnels and SDT Connector** for more details on using the SDT Connector for telnet and SSH access to devices that are attached to the console server serial ports.

4. Serial Port, Host, Device and User Configuration

You can also use standard communications packages like PuTTY to set a direct telnet (or SSH) connection to the serial ports.

Note: PuTTY also supports telnet (and SSH). The procedure to set up a telnet session is simple. Enter the console server's IP address as the 'Host Name (or IP address)'. Select **Telnet** as the protocol and set the TCP port to **2000, plus the physical serial port number** (i.e. 2001 to 2048).

Click the **Open** button. You may receive a security alert stating the host's key is not cached. If this is the case, you will need to choose **yes** to continue. You will then be presented with the login prompt of the remote system connected to the serial port chosen on the console server. You can login as normal and use the host serial console screen.

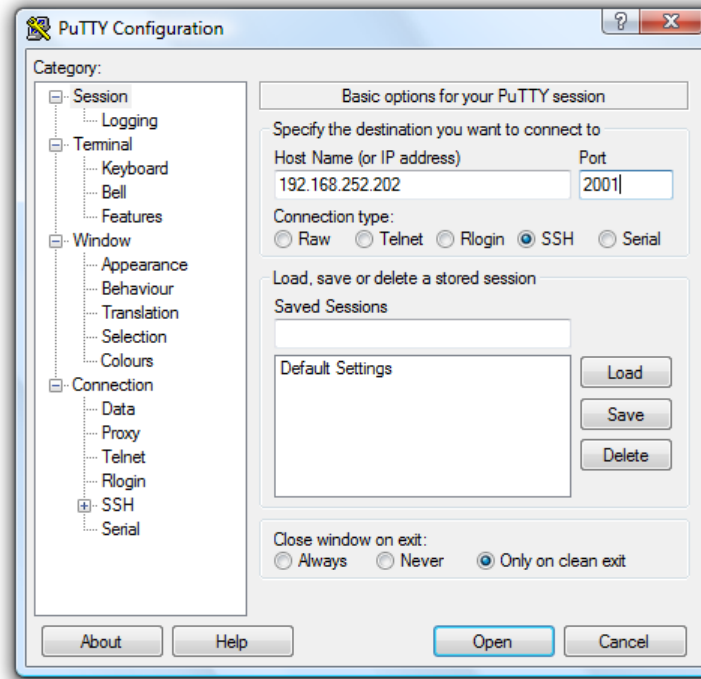

PuTTY can be downloaded at <http://www.tucows.com/preview/195286.html>

Note: In Console Server mode, when you connect to a serial port, you connect via pmshell. To generate a BREAK on the serial port, type the character sequence ~b. If doing this over OpenSSH, type ~-b.

SSH It is recommended you use SSH as the protocol where the User or Administrator connects to the console server (or connects through the console server to the attached serial consoles) over the Internet or any other public network. This will provide authenticated SSH communications between the SSH client program on the remote user's computer and the console server, so the user's communication with the serial device attached to the console server is secure.

For SSH access to the consoles on devices attached to the console server serial ports, you can use SDT Connector. You configure SDT Connector with the console server as a gateway, then as a host, and you enable SSH service on Port (3000 + serial port #) i.e. 3001-3048.

You can also use common communications packages like PuTTY or SSHTerm to SSH connect directly to port address IP Address _ Port (3000 + serial port #) i.e. 3001-3048.

Alternately, SSH connections can be configured using the standard SSH port 22. The serial port being accessed is then identified by appending a descriptor to the username. This syntax supports:

```
<username>:<portXX>
<username>:<port label>
<username>:<ttySX>
<username>:<serial>
```

For example, in order for a User named "Fred" to access serial port 2, when setting up the SSHTerm or the PuTTY SSH client, instead of typing **username = fred** and **ssh port = 3002**, the alternate is to type **username = fred:port02** (or **username = fred:ttyS1**) and **ssh port = 22**.

4. Serial Port, Host, Device and User Configuration

Or, by typing `username=fred:serial` and `ssh port = 22`, the User is presented with a port selection option:

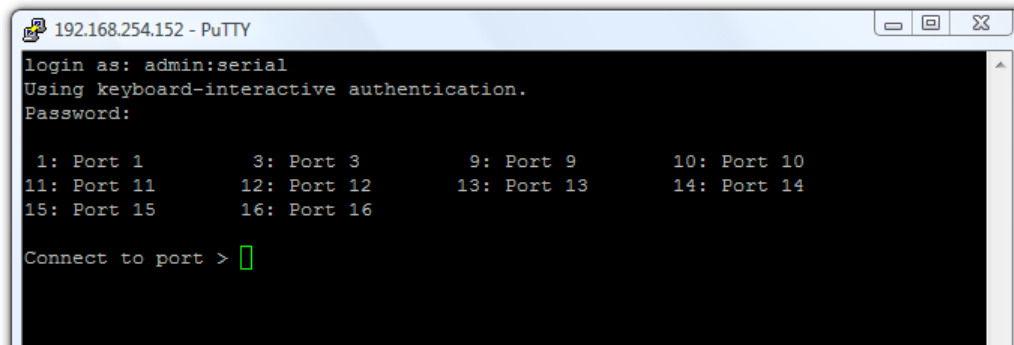

```
192.168.254.152 - PuTTY
login as: admin:serial
Using keyboard-interactive authentication.
Password:

 1: Port 1      3: Port 3      9: Port 9     10: Port 10
11: Port 11    12: Port 12    13: Port 13    14: Port 14
15: Port 15    16: Port 16

Connect to port > █
```

This syntax enables Users to set up SSH tunnels to all serial ports with only a single IP port 22 having to be opened in their firewall/gateway

Note: In Console Server mode, when you connect to a serial port, you connect via `pshell`. To generate a `BREAK` on the serial port, type the character sequence `~b`. If connecting over `OpenSSH`, type `~b`.

TCP RAW TCP allows connections directly to a TCP socket. However, while communications programs like **PuTTY** also supports RAW TCP, this protocol would usually be used by a custom application.

For RAW TCP, the default port address is IP Address _ Port (4000 + serial port #) i.e. 4001 – 4048.

RAW TCP also enables the serial port to be tunneled to a remote console server, so two serial port devices can be transparently interconnect over a network (refer to section **4.1.6 Serial Bridging**).

RFC2217

Selecting RFC2217 enables serial port redirection on that port. For RFC2217, the default port address is IP Address _ Port (5000 + serial port #) i.e. 5001 – 5048.

RFC2217 also enables the serial port to be tunneled to a remote console server, so two serial port devices can be transparently interconnect over a network (refer to section **4.1.6 Serial Bridging**).

Unauthenticated Telnet Selecting Unauthenticated Telnet enables telnet access to the serial port without authentication credentials. When a user accesses the console server to telnet to a serial port, they are normally provided a login prompt. However, with unauthenticated telnet, they connect directly to the port without any console server login restrictions (if a telnet client does prompt for authentication, any entered data will allow connection).

This mode is mainly used when you have an external system (such as `conserver`) to manage user authentication and access privileges at the serial device level.

NB: only the connection to the console server is unauthenticated. Logging into a device connected to the console server may still require authentication.

For Unauthenticated telnet, the default port address is IP Address _ Port (6000 + serial port #) i.e. 6001 – 6048.

Unauthenticated SSH Selecting Unauthenticated SSH enables SSH access to the serial port without authentication credentials. When a user accesses the console server to telnet to a serial port, they are normally provided a login prompt. However, with unauthenticated SSH, they connect directly to the port without any console server login challenge (if a SSH client does prompt for authentication, any entered data will allow connection).

This mode is primarily used when you have another system managing user authentication and access privileges at the serial device level, but still wish to encrypt the session across the network.

NB: only the connection to the console server is unauthenticated. Logging into a device connected to the console server may still require authentication.

For Unauthenticated telnet, the default port address is IP Address _ Port (7000 + serial port #) i.e. 7001 – 7048.

Note: The `<username>`: method of port access (as described in the above **SSH** section) always requires authentication.

4. Serial Port, Host, Device and User Configuration

Web Terminal

Selecting Web Terminal enables web browser access to the serial port via **Manage: Devices: Serial** using the management console's built in AJAX terminal. Web Terminal connects as the currently authenticated management console user and does not re-authenticate. See section **13.3 Terminal Connection** for details.

IP Alias

Enable access to the serial port using a specific IP address specified in CIDR format. Each serial port can be assigned one or more IP aliases, configured on a per-network-interface basis. For example, a serial port can be made accessible at both 192.168.0.148 (as part of the internal network) and 10.10.10.148 (as part of the Management LAN). It is also possible to make a serial port available on two IP addresses on the same network (e.g., 192.168.0.148 and 192.168.0.248).

These IP addresses can only be used to access the specific serial port using the standard protocol TCP port numbers of the console server services. For example, SSH on serial port 3 would be accessible on port 22 of a serial port IP alias (whereas on the console server's primary address, it is available on port 2003).

This feature can also be configured from the multiple port edit page. In this case, the IP addresses are applied sequentially. The first selected port receives the IP address entered, while subsequent ports receive incremental addresses with numbers being skipped for any ports unselected. For example, if ports 2, 3 and 5 are selected and the IP alias 10.0.0.1/24 is entered for the network interface, the following addresses will be assigned:

Port 2: 10.0.0.1/24

Port 3: 10.0.0.2/24

Port 5: 10.0.0.4/24

Accumulation Period

By default, once a connection has been established for a particular serial port (such as an RFC2217 redirection or telnet connection to a remote computer), any incoming characters on that port are forwarded over the network on a character-by-character basis. The accumulation period changes this by specifying a period of time that incoming characters will be collected before being sent as a packet over the network.

Escape Character

This enables you to change the character used for sending escape characters. The default is ~.

Power Menu

This setting enables the shell power command so a user can control the power connection to a managed device from command line when they are connected to the device via telnet or SSH. To operate, the managed device must be set up with both its serial port connection and power connection configured. The command to open the power menu is ~p

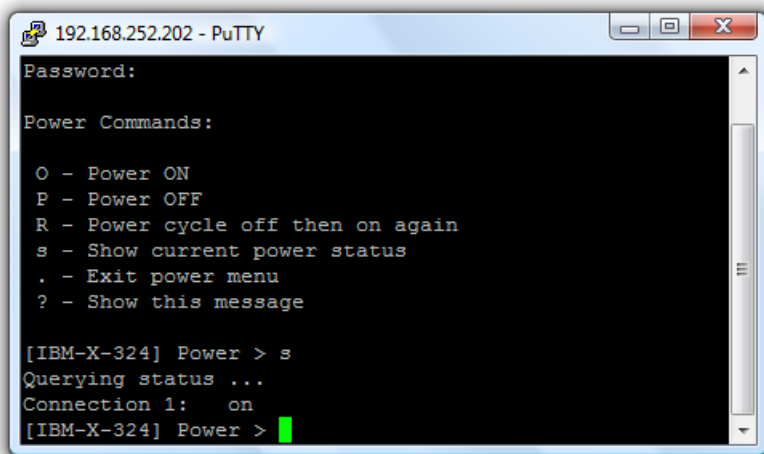

```
192.168.252.202 - PuTTY
Password:

Power Commands:

O - Power ON
P - Power OFF
R - Power cycle off then on again
s - Show current power status
. - Exit power menu
? - Show this message

[IBM-X-324] Power > s
Querying status ...
Connection 1: on
[IBM-X-324] Power >
```

Single Connection

This setting limits the port to a single connection, so multiple users have access privileges for a particular port. Only one user at a time can access that port (port "snooping" is not permitted).

4. Serial Port, Host, Device and User Configuration

4.1.3 SDT Mode

This secure tunneling setting allows port forwarding of RDP, VNC, HTTP, HTTPS, SSH, telnet and other LAN protocols to computers locally connected to the console server by their serial COM port. However, such port forwarding requires a PPP link to be set up over this serial port.

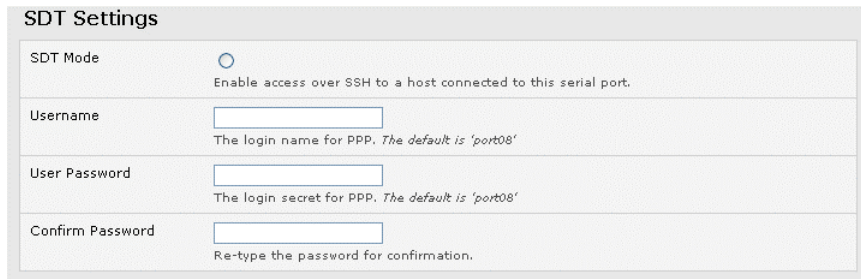

The screenshot shows the 'SDT Settings' configuration form. It includes a radio button for 'SDT Mode' with the description 'Enable access over SSH to a host connected to this serial port.' Below this are three text input fields: 'Username' (description: 'The login name for PPP. The default is 'port08''), 'User Password' (description: 'The login secret for PPP. The default is 'port08''), and 'Confirm Password' (description: 'Re-type the password for confirmation.').

For configuration details, refer to section **6.4 SDT Connector: Using Telnet or SSH to Connect Devices** that are Serially Attached to the Console Server.

4.1.4 Device (RPC, UPS, EMD) Mode

This mode configures the selected serial port to communicate with a serial-controlled Uninterruptable Power Supply (UPS), Remote Power Controller / Power Distribution Unit (RPC) or Environmental Monitoring Device (EMD).

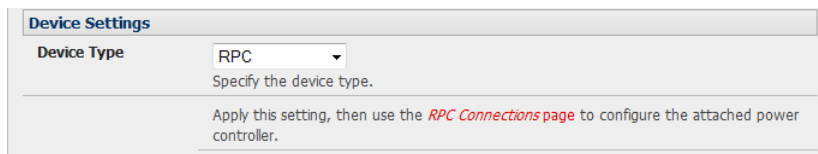

The screenshot shows the 'Device Settings' configuration form. It features a 'Device Type' dropdown menu currently set to 'RPC', with the instruction 'Specify the device type.' Below the dropdown, there is a note: 'Apply this setting, then use the [RPC Connections page](#) to configure the attached power controller.'

Select the desired **Device Type** (UPS, RPC or EMD).

Proceed to the appropriate device configuration page (**Serial & Network: UPS Connections, RPC Connection or Environmental**) as detailed in section **8. Power, Environment and Digital I/O**.

4.1.5 Terminal Server Mode

Select **Terminal Server Mode** and the **Terminal Type** (vt220, vt102, vt100, Linux or ANSI) to enable a getty on the selected serial port



The screenshot shows the 'Terminal Server Settings' configuration form. It includes a radio button for 'Terminal Server Mode' with the description 'Enable a TTY login for a local terminal attached to this serial port.' Below this is a 'Terminal Type' dropdown menu currently set to 'vt220', with the instruction 'The terminal standard to use on this serial port.'

The getty will then configure the port and wait for a connection to be made. An active connection on a serial device is usually indicated by the Data Carrier Detect (DCD) pin on the serial device. When a connection is detected, the getty program issues a login: prompt, then invokes the login program to handle the actual system login.

Note: Selecting Terminal Server mode will disable Port Manager for that serial port. Data will no longer log for alerts etc.

4. Serial Port, Host, Device and User Configuration

4.1.6 Serial Bridging Mode

With serial bridging, the serial data on a console server's serial port is organized in network packets and transported over a network to a second console server, effectively allowing the two console servers to act as a virtual serial cable on an IP network.

One console server is configured to be the Server. The Server serial port to be bridged is set in Console Server mode with either RFC2217 or RAW enabled (refer to **4.1.2 Console Server Mode**).

For the Client console server, the serial port to be bridged must be set in Serial Bridging Mode:

Serial Bridge Settings	
Serial Bridging Mode	<input type="radio"/> Create a network connection to a remote serial port via RFC-2217.
Server Address	<input type="text"/> The network address of an RFC-2217 server to connect to.
Server TCP Port	<input type="text"/> The TCP port the RFC-2217 server is serving on.
RFC 2217	<input type="checkbox"/> Enable RFC 2217 access.
SSH Tunnel	<input type="checkbox"/> Redirect the serial bridge over an SSH tunnel to the server

- Select **Serial Bridging Mode** and specify the IP address of the Server console and the TCP port address of the remote serial port (for RFC2217 bridging, this will be 5001-5048).
- By default, the bridging client will use RAW TCP. You must select RFC2217 if this is the console server mode you have specified on the server console.

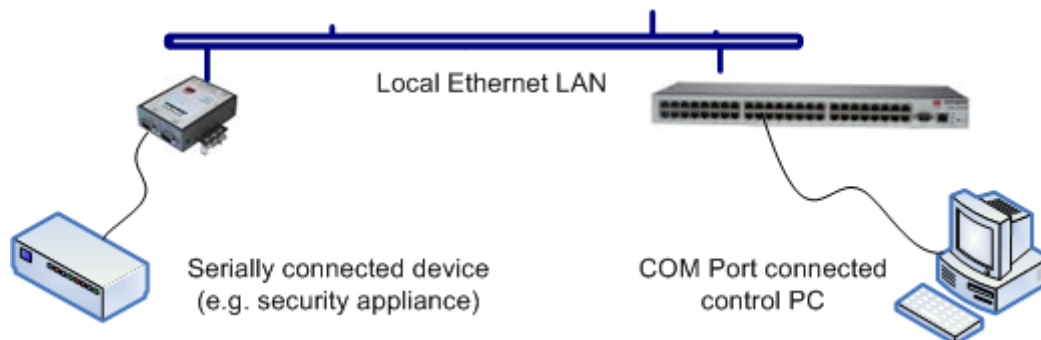

- You may secure the communications over the local Ethernet by enabling SSH. However, you will need to generate and upload keys (refer to section **14. Configuration from the Command Line**).

4.1.7 Syslog

In addition to built-in logging and monitoring (which can be applied to serial-attached and network-attached management accesses, as covered in section **7. Alerts, Auto-Response and Logging**), the console server can also be configured to support the remote syslog protocol on a per serial port basis.

Select the Syslog Facility and Syslog Priority fields to enable traffic logging on the syslog server's selected. Doing so will appropriately sort and create an action for those logged messages (e.g., redirect or send an alert email).

For example, if the computer attached to serial port 3 should never send anything out on its serial console port, the Administrator can set the Syslog Facility for that port to local0 (local0 – local7 are meant for site local values), and the Syslog Priority to critical. At this priority, if the console server syslog server does receive a message, it will automatically create an alert. See **7. Alerts, Auto-Response and Logging** for more information.

4. Serial Port, Host, Device and User Configuration

4.1.8 USB Consoles

B093, B097, and B098 model console servers running firmware 3.16.5 or later support USB console connections to devices from a wide range of vendors, including Cisco, HP, Dell and Brocade. All the USB ports on these console servers can also function as plain RS-232 serial ports when a USB-to-serial adapter is connected.

These USB ports are available as regular port manager ports and are presented numerically in the web UI after all RJ45 serial ports.

The RJ45 serial ports are presented in **Serial & Network > Serial Port**.

The common settings (baud rate, etc.) are used when configuring the ports. Some operations (e.g., sending serial breaks) may not work, depending on the implementation of the underlying USB serial chip.

4.1.9 Link Layer Discovery Protocol (LLDP)

The Link Layer Discovery Protocol (LLDP) is a protocol that allows system administrators to gather information about devices physically connected to managed switches. It is available for use on B093-Series devices.

The LLDP service is enabled through the **System > Services** page. When the service is enabled, the lldpd daemon is loaded and running. The **Service Access** tab controls which network interfaces are monitored by the lldpd daemon.

When LLDP is granted access to an interface, it will use that interface, even if the interface has been disabled through **System > IP**.

LLDP neighbors are visible through the **Status > LLDP Neighbors** page. This page shows neighbors detected and indicates the console manager is sending information.

Note: Although the LLDP service can be granted access to non-Ethernet interfaces (for example, G3, G4 and PSTN dial-up interfaces), it currently ignores non-Ethernet interfaces.

The lldpcli shell client interacts with and configures the running LLDP service.

Persistent custom configuration changes can be added to the system through configuration files placed in `/etc/config/lldpd.d/`. Custom configuration files (which must have filenames ending with `.conf`) will be read and executed by lldpcli when the LLDP service starts.

The `/etc/` directory is read-only on Tripp Lite hardware. Most default configuration files otherwise stored in `/etc/` are on Tripp Lite hardware in `/etc/config/`, which is writeable.

The default lldpd configuration file **lldpd.conf** is saved in `/etc/config/` on Tripp Lite hardware. It is not safe to save custom configuration details. There are circumstances in which this file is regenerated automatically, in which case all customizations will be lost.

The **etc/config/lldpd.d/** directory, which is also writable and created on first boot is safe to write to. Any Custom LLDP configurations must be stored as ***.conf** files in this directory.

When enabled, LLDP frames issued by a Tripp Lite Console Manager will reveal sensitive information such as hostname and firmware version.

LLDP frames are not passed through by 802.3ab compliant switches. Tripp Lite Console Managers have the LLDP service disabled by default.

Both lldpd and lldpcli have standard manual pages but because of space concerns, these pages are not shipped with Tripp Lite hardware. However, both manual pages are available on the lldpd project: man lldpd can be found at

<https://vincentbernat.github.io/lldpd/usage.html#lldpd8>; and man lldpcli can be found at

<https://vincentbernat.github.io/lldpd/usage.html#lldpcli8>.

Note: Tripp Lite uses lldpd 0.9.2.

4. Serial Port, Host, Device and User Configuration

4.2 Add and Edit Users

The Administrator uses this menu selection to set up, edit and delete users, and define the access permissions for each of these users.



System Name: b093-008-2e4u-v Model: B093-008-2E4U-V Firmware: 4.0.0u1
Uptime: 1 days, 19 hours, 13 mins, 4 secs Current User: root



Serial & Network: Users & Groups

Manage | Status | **Serial & Network** | Alerts & Logging | System

- Serial Port
- Users & Groups**
- Authentication
- Network Hosts
- Trusted Networks
- IPsec VPN
- OpenVPN
- PPTP VPN
- Cascaded Ports
- UPS Connections
- RPC Connections
- Environmental
- Managed Devices
- IP Passthrough

Groups	
Name	Description
admin	Provides users with unlimited configuration and management privileges
netgrp	Group for users created automatically via network authentication Edit
pptpd	Group to allow access to the PPTP VPN server - Users in this group will have their password stored in clear text.
dialin	Group to allow dialin access via modems - Users in this group will have their password stored in clear text.
ftp	Group to allow ftp access and file access to storage devices
pmshell	Group to set default shell to pmshell
pmoperator	Group to allow access to all serial ports and managed devices, including portmanager shell access. Please note that portmanager shell access overrides UNIX shell access
users	Provides users with basic management privileges

[Add Group](#)

Users		
Username	Group	Description
root	The root user has no editable groups	Root User - changed pw Edit Disable

[Add User](#)

Users can be authorized to access specified services, serial ports, power devices and specified network-attached hosts. These users can also be given full Administrator status (with full configuration, management and access privileges).

To simplify user set up, they can be configured as members of Groups. With firmware V3.5.2 and later, there are six Groups set up by default (earlier versions only had admin and user by default):

- admin** Provides users with unlimited configuration and management privileges.
- pptpd** Group to allow access to the PPTP VPN server. Passwords for users in this group are stored in plain text.
- dialin** Group to allow dial-in access via modems. Passwords for users in this group are stored in plain text.
- ftp** Group to allow ftp access and file access to storage devices.
- pmshell** Group to set default shell to pmshell.
- users** Provides users with basic management privileges.

- Notes:**
- The admin group provides the admin user with full Administrator privileges. The admin user (Administrator) can access the console server using any of the services enabled in **System: Services** (e.g., if only HTTPS has been enabled, then the Administrator can only access the console server using HTTPS). However, once logged in, they can reconfigure the console server settings (e.g., to enable HTTP/telnet for future access). They can also access any of the connected hosts or serial port devices using any of the services enabled for these connections. The Administrator can reconfigure the access services for any host or serial port. Only trusted users should have Administrator access.
 - The user group provides the general user with limited access to the console server, connected hosts and serial devices. These Users can access only the management section of the Management Console menu with no command line access to the console server. They also can only access those hosts and serial devices that have been checked for them.
 - If a user is set up with **pptd**, **dialin**, **ftp** or **pmshell** group membership, they will have restricted user shell access to the assigned managed devices but will not have any direct access to the console server itself. To add this function, the user must also be a member of the "users" or "admin" groups.

4. Serial Port, Host, Device and User Configuration

4. The Administrator can also set up additional groups with permissions to a specific power device, serial port and host access. However, users in these additional groups do not have any access to the Management Console menu nor do they have any command line access to the console server itself.
5. The Administrator can also set up users with specific power device, serial port and host access permissions, who are not a member of any Groups. Similarly, these users do not have any access to the Management Console menu, nor do they have any command line access to the console server itself.
6. For convenience, the SDT Connector "Retrieve Hosts" function retrieves and autoconfigures checked serial ports and checked hosts only, even for admin group users.

4.2.1 Set Up New Group

To set up new groups and users, and assign users to particular groups:

- Select **Serial & Network: Users & Groups** to display the configured Groups and Users.
- Click **Add Group** to add a new group.



System Name: b093-008-2e4u-v Model: B093-008-2E4U-V Firmware: 4.0.0u1
Uptime: 1 days, 19 hours, 15 mins, 4 secs Current User: root



- Add a **Group** name and **Description** for each new Group. Then select the **Accessible Hosts**, **Accessible Ports** and **Accessible RPC Outlet(s)** you wish for users in this new group to be able to access.
- Click **Apply**.
- The Administrator can **Edit** or **Delete** any added group.

4. Serial Port, Host, Device and User Configuration

4.2.2 Set Up New Users

To set up new users, and assign users to particular groups:

- Select **Serial & Network: Users & Groups** to display the configured groups and user.
- Click **Add User** to add a new user.



System Name: b093-008-2e4u-v Model: B093-008-2E4U-V Firmware: 4.0.0u1
Uptime: 1 days, 19 hours, 16 mins, 19 secs Current User: root



- Add a **Username** for each new user. You may also include information related to the user (e.g., contact details) in the **Description** field.
Note: The username can contain from 1 to 127 alphanumeric characters (special characters “-” “_” and “.” may also be used).
- Specify which **Group** (or Groups) you wish to assign the user to.
- Add a confirmed **Password** for each new user.
Note: There are no restrictions on the characters that can be used for the user's password (which each can contain up to 254 characters). However, only the first eight password characters are used to make the password hash.
- SSH pass-key authentication can be used. This is more secure than password-based authentication. Paste the public keys of authorized public/private key pairs for this user in the **Authorized SSH Keys** field.
- Check **Disable Password Authentication** if you wish to only allow public key authentication for this user when using SSH.
- Check **Enable Dial-Back** in the **Dial-in Options** menu to allow an outgoing dial-back connection to be triggered by logging into this port. Enter the **Dial-Back Phone Number** with the phone number to call back when user logs in.
- Check specific **Accessible Hosts** and/or **Accessible Ports** to assign the serial ports and network-connected hosts you wish the user to have access privileges to.
- If there are configured RPCs, you can check **Accessible RPC Outlets** to specify which outlets the user can control (i.e. Power On/Off).
- Click **Apply**. The new user will now be able to access the Network Devices, Ports and RPC Outlets you assigned as accessible. If the user is a group member, they can also access any other device/port/outlet that was set up as accessible to that group.

4. Serial Port, Host, Device and User Configuration

Note: There are no specific limits on the number of users you can set up, nor on the number of users per serial port or host. Multiple users (Users and Administrators) can control/monitor the one port or host. Similarly, there are no specific limits on the number of groups. Each user can be a member of multiple groups (in which case, they assume the cumulative access privileges of each of those groups). A user does not have to be a member of any groups. If the user is not a member of the default user group, then they will not be able to use the management console to manage ports.

While there are no specific limits, the time to reconfigure does increase as the number and complexity increases. As such, the recommended aggregate number of users and groups should be kept under 250.

The Administrator can also edit the access settings for any existing users:

- Select **Serial & Network: Users & Groups** and click **Edit** to modify the user access privileges.
- Alternately, click **Delete** to remove the user or click **Disable** to temporarily block any access privileges.

Note: For more information on enabling the SDT Connector so each user has secure tunneled remote RPD/VNC/Telnet/HHTP/HTTPS/SoL access to the network-connected hosts, refer 6. SSH Tunnels and SDT Connector.

4.3 Authentication

Refer to Chapter 9.1 - Remote Authentication Configuration for authentication configuration details.

4.4 Network Hosts

To monitor and remotely access a locally networked computer or device (referred to as a host), you must identify the host and specify the TCP or UDP ports/services that will be used to control that host:

Serial & Network: Network Hosts						
IP Address/DNS Name	Host Name	Description/Notes	Permitted Services	Device Type		
192.168.0.44	IBM-X-324	Asterisk PBX	22/tcp (ssh) 0, 443/tcp (https) 0		Edit	Delete
192.168.0.70	PowerEdgeR9000-5	Dell mail server	22/tcp (ssh) 0, 443/tcp (https) 0, 5900/tcp (vnc) 0		Edit	Delete
192.168.0.46	MainUPS	Computer room battery	80/tcp (http) 0	UPS	Edit	Delete
192.168.253.240	PDU-R7D	Baytech PDU	23/tcp (telnet) 0, 80/tcp (http) 0	RPC	Edit	Delete
192.168.0.39	PDU-R5A	PowerWare PDU	22/tcp (ssh) 0, 23/tcp (telnet) 0, 80/tcp (http) 0, 443/tcp (https) 0, 1494/tcp (ica) 0, 3389/tcp (rdp) 0, 5900/tcp (vnc) 0	RPC	Edit	Delete

**Access to this service will be logged.*

Selecting **Serial & Network: Network Hosts** presents all the network-connected hosts that have been enabled for access, as well as the related access TCP ports/services.

4. Serial Port, Host, Device and User Configuration

Click **Add Host** to enable access to a new host (or select **Edit** to update the settings for existing host).

System Name: b093-008-2e4u-v Model: B093-008-2E4U-V Firmware: 4.0.0u1
Uptime: 1 days, 19 hours, 20 mins, 37 secs Current User: root

Dashboard Manage Devices Backup Log Out

Serial & Network: Network Hosts

Manage | **Status** | **Serial & Network** | **Alerts & Logging** | **System**

- Serial Port
- Users & Groups
- Authentication
- Network Hosts
- Trusted Networks
- IPsec VPN
- OpenVPN
- PPTP VPN
- Cascaded Ports
- UPS Connections
- RPC Connections
- Environmental
- Managed Devices
- IP Passthrough

IP Address/DNS Name []
The host's IP Address or DNS name.

Host Name []
A descriptive name to identify the host.

Description/Notes []
A brief description of the host.

Permitted Services

22/tcp (ssh) - 0
23/tcp (telnet) - 0
80/tcp (http) - 0
443/tcp (https) - 0
1494/tcp (ica) - 0
3389/tcp (rdp) - 0
5900/tcp (vnc) - 0

Remove

TCP
 UDP Port []
level 0 - Disabled
Add
The TCP services available from this host.

Device Settings

Device Type [None] device type.
Apply

Enter the **IP Address** or **DNS Name** and a **Host Name** (up to 254 alphanumeric characters) for the new network-connected host. You can optionally enter a **Description**.

Add or edit the **Permitted Services** (or TCP/UDP port numbers) authorized for controlling this host. Only these permitted services will be forwarded by SDT to the host. All other services (TCP/UDP ports) will be blocked.

The **Logging Level** specifies the level of information to be logged and monitored for each host access (refer to **7. Alerts, Auto-response and Logging** for more information).

If the host is a PDU or UPS power device or a server with IPMI power control, then specify **RPC** (for IPMI and PDU) or **UPS** and the Device Type. The Administrator can then configure these devices and enable which users have permissions to remotely cycle power etc. (refer to **8. Remote Power Control** for more information). Otherwise, leave the Device Type set to **None**.

» Nagios

Status

- Port Access
- Active Users
- Statistics
- Support Report
- Syslog
- UPS Status
- RPC Status
- Environmental Status

Manage

- Devices
- Port Logs
- Host Logs
- Power
- Terminal

Device Settings

Device Type [None] device type.
None
UPS
RPC

Nagios Settings

Enable Nagios
Switch Nagios on for this host

Host Name []
Name of host in Nagios. Generated using host description if unspecified.

Nagios Checks [New Check] [Clear check-host-alive]

Apply

If the console server has been configured with distributed Nagios monitoring enabled, you will also be presented with **Nagios Settings** options to enable assigned services on the host to be monitored (refer to **10. Nagios Integration**).

Click **Apply**. This will create the new host and create a new managed device with the same name.

4. Serial Port, Host, Device and User Configuration

4.5 Trusted Networks

The **Trusted Networks** facility provides an option to assign specific IP addresses that users (Administrators and Users) must be located in order to have access to console server serial ports:

- Select **Serial & Network: Trusted Networks**.
- To add a new trusted network, select **Add Rule**.

Note: In the absence of rules, there are no access limitations to the IP address for which Users or Administrators can be located.

- Select the **Accessible Port(s)** that the new rule is applied to.
- Enter the **Network Address** of the subnet to be permitted access.
- Specify the range of addresses that are to be permitted by entering a Network Mask for that permitted IP range.

To permit all the users located with a particular Class C network (204.15.5.0 say) connection to the assigned port then you would add the following Trusted Network New Rule:

Network IP Address	204.15.5.0
Subnet Mask	255.255.255.0

If you want to permit only the one user who is located at a specific IP address (204.15.5.13) to connect:

Network IP Address	204.15.5.13
Subnet Mask	255.255.255.255

4. Serial Port, Host, Device and User Configuration

If you wish to allow all users operating from within a specific range of IP addresses (any of the 30 addresses from 204.15.5.129 to 204.15.5.158) to be permitted connection to the assigned port:

Host /Subnet Address	204.15.5.128
Subnet Mask	255.255.255.224

- Click **Apply**.

Note: The above trusted networks will limit access by Users and Administrators to the console serial ports. However, they do not restrict access by the Administrator to the console server itself or to attached hosts. To change the default settings for this access, you will need to edit the iptables rules as described in section **14. Configuration from the Command Line**.

4.6 Serial Port Cascading

Cascaded Ports enable you to cluster distributed console servers so a large number of serial ports (up to 1000) can be configured and accessed through one IP address and managed through a single management console. The Primary console server controls other console servers as Secondary units and all the serial ports on the Secondary units appear as if they are part of the Primary.

Tripp Lite's clustering connects each Secondary unit to the Primary unit via SSH connection. This is done using public key authentication so the Primary unit can access each Secondary unit using the SSH key pair (rather than using passwords). This ensures secure authenticated communications between Primary and Secondary units, enabling the Secondary units to be distributed locally on a LAN or remotely.

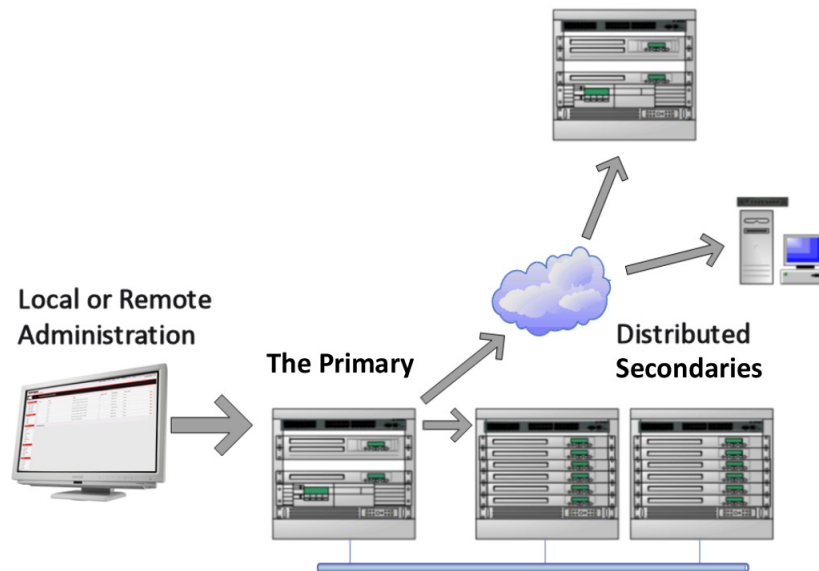

4. Serial Port, Host, Device and User Configuration

4.6.1 Automatically Generate and Upload SSH keys

To set up public key authentication, you must first generate an RSA or DSA key pair and upload them into the Primary and Secondary console servers. This can all be done automatically from the Primary unit:

System Name	<input type="text" value="img4004-5"/> <small>An ID for this device.</small>
System Description	<input type="text"/> <small>The physical location of this device.</small>
System Password	<input type="password" value="••••••"/> <small>The secret used to gain administration access to this device.</small>
Confirm System Password	<input type="password" value="••••••"/> <small>Re-enter the above password for confirmation.</small>
<input type="button" value="Apply"/>	
SSH RSA Public Key	<input type="text"/> <small>Upload a replacement RSA public key file.</small> <input type="button" value="Browse..."/>
SSH RSA Private Key	<input type="text"/> <small>Upload a replacement RSA private key file.</small> <input type="button" value="Browse..."/>
SSH DSA Public Key	<input type="text"/> <small>Upload a replacement DSA public key file.</small> <input type="button" value="Browse..."/>
SSH DSA Private Key	<input type="text"/> <small>Upload a replacement DSA private key file.</small> <input type="button" value="Browse..."/>
SSH Authorized Keys	<input type="text"/> <small>Upload a replacement authorized keys file.</small> <input type="button" value="Browse..."/>
Generate SSH keys automatically	<input checked="" type="checkbox"/> <small>Generate SSH keys locally.</small>
<input type="button" value="Apply"/>	

- Select **System: Administration** on the Primary unit's management console.
- Check **Generate SSH keys automatically** and click **Apply**.



System Name: b093-008-2e4u-v Model: B093-008-2E4U-V Firmware: 4.0.0u1
Uptime: 1 days, 19 hours, 30 mins, 59 secs Current User: root



System: SSH Keys	
Manage	Generating each set of keys will require approximately two minutes. Any old keys of that type will be destroyed. Functions relying on SSH keys (e.g. Cascading) may stop functioning until they are updated with the new set of keys. If unsure, select only RSA.
Status	To generate keys, select one or more of the following key types:
Serial & Network	RSA Keys <input checked="" type="checkbox"/> Generate RSA Keys
» Serial Port	ECDSA Keys <input checked="" type="checkbox"/> Generate ECDSA Keys
» Users & Groups	ED25519 Keys <input checked="" type="checkbox"/> Generate ED25519 Keys
» Authentication	<input type="button" value="Apply"/>
» Network Hosts	
» Trusted Networks	
» IPsec VPN	
» OpenVPN	
» PPTP VPN	
» Cascaded Ports	
» UPS Connections	
» BPC Connections	

Next, you must select whether to generate keys using RSA and/or DSA (if unsure, select only RSA). Generating each set of keys will take approximately two minutes. During this time, the new keys will destroy any old keys that may previously been uploaded. Also, relying on SSH keys (e.g., cascading) may stop functioning until they are updated with the new set of keys. To generate keys:

- Select **RSA Keys** and/or **DSA Keys**.
- Click **Apply**.
- Once the new keys have been successfully generated, click on the link **Click here to return**. The keys will automatically be uploaded to the Primary and connected Secondary units.

4. Serial Port, Host, Device and User Configuration

4.6.2 Manually Generate and Upload SSH Keys

Alternately, if you have a RSA or DSA key pair you can manually upload them to the Primary and Secondary console servers.

*Note: If you do not already have RSA or DSA key pair and you do not wish to use you will need to create a key pair using ssh-keygen, PuTTYgen or a similar tool as detailed in **15.6 Secure Shell (SSH) Public Key Authentication**.*

To manually upload the public and private key pair to the Primary console server:

- Select **System: Administration** on the Primary unit's management console.
- Browse to the location you saved the RSA (or DSA) public key and upload it to **SSH RSA (DSA) Public Key**.
- Browse to the saved RSA (or DSA) private key location and upload it to **SSH RSA (DSA) Private Key**.
- Click **Apply**.

SSH RSA Public Key	<input type="button" value="Choose File"/> No file chosen Upload a replacement RSA public key file.
SSH RSA Private Key	<input type="button" value="Choose File"/> No file chosen Upload a replacement RSA private key file.
SSH ECDSA Public Key	<input type="button" value="Choose File"/> No file chosen Upload a replacement ECDSA public key file.
SSH ECDSA Private Key	<input type="button" value="Choose File"/> No file chosen Upload a replacement ECDSA private key file.
SSH ED25519 Public Key	<input type="button" value="Choose File"/> No file chosen Upload a replacement ED25519 public key file.
SSH ED25519 Private Key	<input type="button" value="Choose File"/> No file chosen Upload a replacement ED25519 private key file.
Generate SSH keys automatically	<input type="checkbox"/> Generate SSH keys locally.
<input type="button" value="Apply"/>	

Next, you must register the public key as an authorized key on the Secondary unit. You will only need to upload one RSA or DSA public key for each Secondary unit.

Note: *The use of key pairs may be confusing because in many cases, one file (public key) fulfills two roles – public key and authorized key. For a more information, refer to **15.6 Secure Shell (SSH) Public Key Authentication**.*

Select **System: Administration** on the Secondary unit's management console

- Browse again to the saved RSA (or DSA) public key and upload it to the Secondary unit's **SSH Authorized Key**.
- Click **Apply**.

The next step is to Fingerprint each new Secondary-Primary connection. This once-off step will validate your SSH session. On first connection, the Secondary will receive a fingerprint from the Primary unit, which will be used on all future connections:

- To establish the fingerprint, first log in to the Primary server as root and establish an SSH connection to the Secondary remote host:

```
# ssh remhost
```

Once the SSH connection has been established you will be asked to accept the key. Answer yes and the fingerprint will be added to the list of known hosts. Refer to **15.6 Secure Shell (SSH) Public Key Authentication** for more information.

- If asked to supply a password, there is a problem with uploading keys. The keys should remove any need to supply a password.

4. Serial Port, Host, Device and User Configuration

4.6.3 Configure the Secondary Units and their Serial Ports

To begin setting up the Secondary units and configuring Secondary serial ports from the Primary console server:

System Name: b093-008-2e4u-v Model: B093-008-2E4U-V Firmware: 4.0.0u1
Uptime: 1 days, 19 hours, 40 mins, 11 secs Current User: root

Dashboard Manage Devices Backup Log Out

Serial & Network: Cascaded Ports

IP Address/DNS Name	Description	Label	Number of Ports	Locally Allocated Port Numbers
No slaves currently configured.				

Add Slave

- Select **Serial & Network: Cascaded Ports** on the Primary unit's management console:
- To add clustering support, select **Add Slave** (Secondary).

Note: You will be prevented from adding any Secondary units until you have automatically or manually generated SSH keys:

Serial & Network: Cascaded Ports

Slaves cannot be added until SSH keys have been generated.
Click [here](#) to go back, or [here](#) to upload or generate keys.

To define and configure a Secondary console server:

- Enter the remote **IP Address** (or DNS Name) for the Secondary console server.
- Enter a brief **Description** and a short **Label** for the Secondary unit (use a convention here that enables effective management of large networks of clustered console servers and the connected devices).
- Enter the full number of serial ports on the Secondary unit in **Number of Ports**.
- Click **Apply**. This will establish the SSH tunnel between the Primary unit and the new Secondary unit.

IP Address/DNS Name	Description	Label	Number of Ports	Locally Allocated Port Numbers	Edit	Delete
201.234.24.3	Denver branch IM4208	DBIM8	8	17 - 24	Edit	Delete
201.234.35.2	Eng IMG7000 3G	EngVM03	16	25 - 40	Edit	Delete
168.34.78.4	Eng hosting site	RIM4216ED	16	41 - 56	Edit	Delete

Add Slave

The **Serial & Network: Cascaded Ports** menu displays all Secondary units and port numbers that have been allocated on the Primary unit. For example, if the Primary console server has 16 ports of its own, then ports 1-16 are pre-allocated to the Primary unit. As a result, the first Secondary unit added will be assigned port number 17.

Once you have added all the Secondary console servers, the Secondary's serial ports and the connected devices are configurable and accessible from the Primary unit's management console menu, accessible through the Primary's IP address.

- Select the appropriate **Serial & Network: Serial Port** and **Edit** to configure the serial ports on the Secondary unit.
- Select the appropriate **Serial & Network: Users & Groups** to add new users with access privileges to the Secondary unit's serial ports (or to extend existing users access privileges).
- Select the appropriate **Serial & Network: Trusted Networks** to specify network addresses that can access assigned Secondary serial ports.
- Select the appropriate **Alerts & Logging: Alerts** to configure Secondary port Connection, State Change or Pattern Match alerts.
- The configuration changes made on the Primary unit are propagated out to all the Secondary units when you click **Apply**.

4. Serial Port, Host, Device and User Configuration

4.6.4 Managing the Secondary Serial Ports

The Primary console server is in control of the Secondary units' serial ports. For example, when changing a User's access privileges or editing any serial port setting on the Primary unit, the updated configuration files will be sent out to each Secondary in parallel. Each Secondary unit will then automatically make changes to their local configurations (and only make those changes that relate to its particular serial ports).

You can still use the local secondary management console to change the settings on any Secondary serial port (e.g., alter the baud rates). However, these changes will be overwritten the next time the Primary console server sends out a configuration file update.

Also, while the Primary unit is in control of all Secondary serial port related functions, it is not Primary over the Secondary network host connections or over the Secondary console server system itself.

So Secondary functions such as IP, SMTP & SNMP Settings and Date & Time, DHCP server must be managed by accessing each Secondary unit directly. These functions are not overwritten when configuration changes are propagated from the Primary console server. Similarly, the Secondary unit's Network Host and IPMI settings have to be configured at each Secondary unit.

The Primary unit's management console also provides a consolidated view of the settings for both serial ports as well as the serial ports for the entire Secondary units. However, the Primary unit does not provide a fully consolidated view. For example, if you want to view who has logged in to cascaded serial ports from the Primary unit, you will see that Status: Active Users only displays those users active on the Primary unit's ports and you may need to write custom scripts to provide this view. For more information, refer to **10. Nagios Integration**.

4.7 Managed Devices

Managed devices present a consolidated view of all connections to a device that can be accessed and monitored through the console server. To view the connections to devices:

- Select **Serial & Network: Managed Devices**.

The screenshot shows the Tripp-Lite management console interface. At the top left is the Tripp-Lite logo. To the right, system information is displayed: System Name: b093-008-2e4u-v, Model: B093-008-2E4U-V, Firmware: 4.0.0u1, Uptime: 1 days, 19 hours, 50 mins, 18 secs, and Current User: root. On the far right are navigation icons for Dashboard, Manage Devices, Backup, and Log Out. The main content area is titled 'Serial & Network: Managed Devices'. On the left is a sidebar menu with 'Serial & Network' expanded to show options like Serial Port, Users & Groups, Authentication, Network Hosts, Trusted Networks, IPsec VPN, OpenVPN, PPTP VPN, Cascaded Ports, UPS Connections, RPC Connections, Environmental, Managed Devices, and IP Passthrough. The main panel has a 'Manage' dropdown menu and a 'Status' section. Below that is a form to 'Add a New Device' with fields for 'Device Name' (with a hint: 'A descriptive name for this device.') and 'Description/Notes' (with a hint: 'A brief description of the device.'). At the bottom of the form is a 'Connections' section with an 'Add Connection' button and an 'Apply' button.

This screen displays all the managed devices with their Description/Notes and lists of all configured connections:

- **Serial Port #** (if serially connected) or
- **USB** (if USB connected)
- IP Address (if network connected)
- Power PDU/outlet details (if applicable) and any UPS connections

Devices such as servers will commonly have more than one power connection (e.g., dual power supplied) and more than one network connection (e.g., for BMC/service processor).

All users can view (but not edit) these managed device connections by selecting Manage: Devices. Only the Administrator can edit and add/delete managed devices and their connections.

4. Serial Port, Host, Device and User Configuration

To edit an existing device and add a new connection:

- Select **Edit** on the **Serial & Network: Managed Devices** and click **Add Connection**.
- Select the connection type for the new connection (Serial, Network Host, UPS or RPC). Then select the specific connection from the presented list of configured unallocated hosts/ports/outlets.

Serial & Network: Managed Devices

Edit an Existing Device

Device Name: IBM-X-324
A descriptive name for this device.

Description/Notes: Asterisk PBX
A brief description of the device.

Connections

Connection Type	Device Name	Outlet Name	Action
Network Host	192.168.0.44		Delete
UPS	MainUPS		Delete
RPC	PDU-R7D	Outlet 3	Delete
Serial	Port 1		Delete

Buttons: Add Connection, Apply

To add a new network-connected managed device:

- The Administrator adds a new network-connected Managed Device using **Add Host** on the **Serial & Network: Network Host** menu. This automatically creates a corresponding new managed device (refer to **4.4 Network Hosts**)
- When adding a new network-connected RPC or UPS power device, you set up a Network Host, designate it as RPC or UPS, then go to **RPC Connections** (or **UPS Connections**) to configure the relevant connection. Again corresponding new Managed Device (with the same Name /Description as the RPC/UPS Host) is not created until this connection step is completed (refer to **8. Power, Environment and Digital I/O**).

Note: The outlet names on this newly created PDU are by default "Outlet 1" "Outlet 2". When connecting a particular managed device that draws power from the outlet, the outlet will take the name of the powered managed device.

To add a new serially connected managed device:

- Configure the serial port using the **Serial & Network: Serial Port** menu (refer to **4.1 Configure Serial Ports**).
- Select **Serial & Network: Managed Devices** and click **Add Device**.
- Enter a **Device Name** and **Description** for the managed device.

Serial & Network: Managed Devices

Add a New Device

Device Name: Router
A descriptive name for this device.

Description/Notes: Cisco 3640 serial console
A brief description of the device.

Connections

Connection Type	Device Name	Action
Serial	Port 2	Delete

Buttons: Add Connection, Apply

- Click **Add Connection**. Select **Serial** and the **Port** that connects to the managed device.
- To add a UPS/RPC power connection, network connection or another serial connection, click **Add Connection**.
- Click **Apply**.

4. Serial Port, Host, Device and User Configuration

Note: To set up a new serially connected RPC, UPS or EMD device, first configure the serial port, designate it as a device, and then enter a name and description for that device in the **Serial & Network: RPC Connections** (or **UPS Connections** or **Environmental**). When applied, this will automatically create a corresponding new managed device with the same name/description as the RPC/UPS host (refer to **8. Power, Environment and Digital I/O**).

The outlet names on the PDU are by default "Outlet 1" "Outlet 2". When connecting a particular managed device that draws power from the outlet, the outlet will take the name of the powered managed device.

4.8 IPsec VPN

The console servers include Openswan, a Linux implementation of the IPsec (IP security) protocols, which can be used to configure a Virtual Private Network (VPN). The VPN allows multiple sites or remote administrators to access the Tripp Lite advanced console server (and managed devices) securely over the internet.

The administrator can establish encrypted authenticated VPN connections between advanced console servers distributed at remote sites and a VPN gateway (such as Cisco router running IOS IPsec) on their central office network:

- Users and administrators at the central office can then securely access the remote console. servers and connected serial console devices and machines on the Management LAN subnet at the remote location as though they were local.
- With serial bridging, serial data from controller at the central office machine can be securely connected to the serially controlled devices at the remote sites (refer to **4.1 Configure Serial Ports**).

The road warrior administrator can use a VPN IPsec software client such as TheGreenBow (www.thegreenbow.com/vpn_gateway.html) or Shrew Soft (www.shrew.net/support) to remotely access the advanced console server and every machine on the Management LAN subnet at the remote location.

Configuration of IPsec is quite complex so Tripp Lite provides a simple GUI interface for basic set up as described below. However, for more detailed information on configuring Openswan IPsec at the command line and interconnecting with other IPsec VPN gateways and road warrior IPsec software, refer <http://wiki.openswan.org>

4.8.1 Enable the VPN Gateway

Select **IPsec VPN** on the **Serial & Networks** menu.

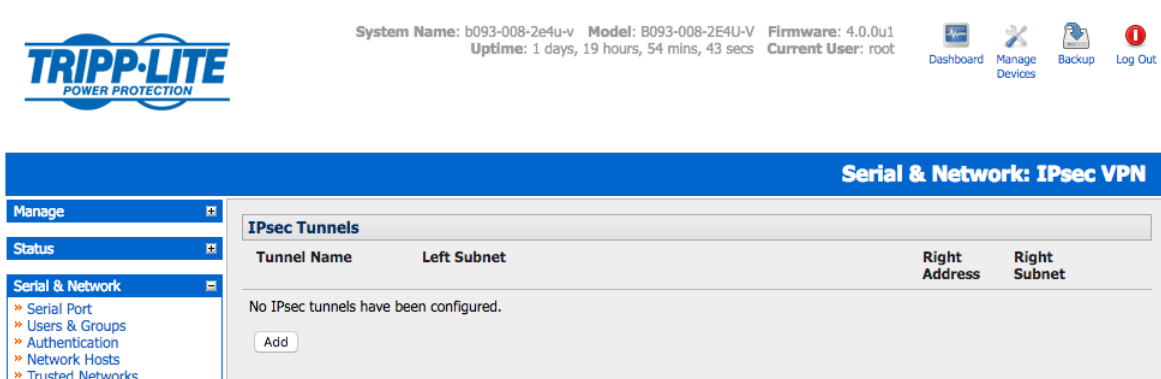

The screenshot shows the Tripp Lite web interface. At the top left is the Tripp Lite logo. To the right, system information is displayed: System Name: b093-008-2e4u-v, Model: B093-008-2E4U-V, Firmware: 4.0.0u1, Uptime: 1 days, 19 hours, 54 mins, 43 secs, Current User: root. On the far right are navigation icons for Dashboard, Manage Devices, Backup, and Log Out. The main content area is titled "Serial & Network: IPsec VPN". On the left is a sidebar menu with "Serial & Network" expanded to show "Serial Port", "Users & Groups", "Authentication", "Network Hosts", and "Trusted Networks". The main panel is titled "IPsec Tunnels" and contains a table with columns: Tunnel Name, Left Subnet, Right Address, and Right Subnet. The table is currently empty, with the text "No IPsec tunnels have been configured." and an "Add" button below it.

4. Serial Port, Host, Device and User Configuration

Click **Add** and complete the **Add IPsec Tunnel** screen.

Enter any descriptive name you wish to identify the IPsec Tunnel you are adding, such as WestStOutlet-VPN.



System Name: b093-008-2e4u-v Model: B093-008-2E4U-V Firmware: 4.0.0u1
Uptime: 1 days, 20 hours, 1 mins, 0 secs Current User: root



Serial & Network: IPsec VPN

Add IPsec Tunnel

Tunnel Name [Text Field]
A descriptive name for the IPsec tunnel

Initiate Tunnel
Initiate the tunnel connection from this end

Security

Authentication Method RSA digital signatures
 Shared secret (PSK)
Authenticate using RSA digital signatures or a shared secret (PSK)

Shared Secret (PSK) (Currently empty)
[Text Area]
A passphrase, must match the passphrase configured at the other end of the tunnel

Authentication Protocol ESP
 AH
Authenticate as part of ESP encryption or separately using the AH protocol

Aggressive Mode
Use IKE aggressive mode to establish the tunnel, leave unchecked to use IKE main mode

IKE Proposal (Phase 1) Negotiable
Algorithm to establish the tunnel, must be specified when using aggressive mode, in the format *cipher-hash-pfsgroup*

Perfect Forward Secrecy
Require perfect forward secrecy of keys

Left ID [Text Field]
The identifier for this end of the tunnel, should include a fully qualified domain name preceded by @, e.g.

Select the **Authentication Method** to be used, either **RSA digital signatures** or a **Shared secret (PSK)**.

- If you select **RSA**, you will be asked **click here to generate keys**. This will generate an RSA public key for the console server (the **Left Public Key**). You will need to find out the key to be used on the remote gateway, and then cut and paste it into the **Right Public Key**.

Add IPsec Tunnel

Tunnel Name [Text Field]
A descriptive name for the IPsec tunnel

Initiate Tunnel
Initiate the tunnel connection from this end

Security

Authentication Method RSA digital signatures
 Shared secret (PSK)
Authenticate using RSA digital signatures or a shared secret (PSK)

Left Public Key 0sAQOrwPWy4usM/JFh459oOGbGhFXgU/hwkoZTA+lyNNYkt7vhWhbi
Generated RSA public key of this end of the tunnel

Right Public Key [Text Field]
RSA public key of the other end of the tunnel

- o If you select **Shared secret**, you will need to enter a pre-shared secret (PSK). The PSK must match the PSK configured at the other end of the tunnel.

4. Serial Port, Host, Device and User Configuration

In **Authentication Protocol**, select the authentication protocol to be used. Either authenticate as part of **ESP** (Encapsulating Security Payload) encryption or separately using the **AH** (Authentication Header) protocol.

Enter a **Left ID** and **Right ID**. The local host/gateway and remote host/gateway use this identifier for IPsec negotiation and authentication. Each ID must include a '@' and can include a fully qualified domain name preceded by '@' (e.g. left@example.com).

Enter the public IP or DNS address of this Tripp Lite VPN gateway as the **Left Address**. You can leave this blank to use the interface of the default route.

In **Right Address**, enter the public IP or DNS address of the remote end of the tunnel (only if the remote end has a static or dyndns address). Otherwise, leave this blank.

If the Tripp Lite VPN gateway is serving as a VPN gateway to a local subnet (e.g. the console server has a management LAN configured), enter the private subnet details in **Left Subnet**. Use the CIDR notation (where the IP address number is followed by a slash and the number of 'one' bits in the binary notation of the netmask). For example, 192.168.0.0/24 indicates an IP address where the first 24 bits are used as the network address. This is the same as 255.255.255.0. If the VPN access is only to the console server itself and to its attached serial console devices, leave **Left Subnet** blank.

If there is a VPN gateway at the remote end, enter the private subnet details in **Right Subnet**. Again, use the CIDR notation and leave blank if there is only a remote host.

Select **Initiate Tunnel** if the tunnel connection is to be initiated from the Left console server end. This can only be initiated from the VPN gateway (Left) if the remote end was configured with a static (or dyndns) IP address.

Click **Apply** to save changes.

Note: It is essential the configuration details set up on the advanced console server (referred to as the Left or Local host) exactly match the setup entered when configuring the Remote (Right) host/gateway or software client.

4.9 OpenVPN

Console servers with firmware version 3.2 and later include OpenVPN. OpenVPN uses the OpenSSL library for encryption, authentication, and certification, which means it uses SSL/TSL (Secure Socket Layer/Transport Layer Security) for key exchange and can encrypt both data and control channels. Using OpenVPN allows for the building of cross-platform, point-to-point VPNs using either X.509 PKI (Public Key Infrastructure) or custom configuration files.

OpenVPN allows secure tunneling of data through a single TCP/UDP port over an unsecured network, thus providing secure access to multiple sites and secure remote administration to a console server over the Internet.

OpenVPN also allows the use of Dynamic IP addresses by both the server and client, thus providing client mobility. For example, an OpenVPN tunnel may be established between a roaming windows client and a Tripp Lite advanced console server within a data center.

Configuration of OpenVPN can be a complex undertaking. For ease and convenience, Tripp Lite provides a simple GUI interface for basic set up as described below. For more detailed information on configuring OpenVPN Access server or client, refer to the HOW TO and FAQs at <http://www.openvpn.net>.

4. Serial Port, Host, Device and User Configuration

4.9.1 Enable the OpenVPN

Select **OpenVPN** on the **Serial & Networks** menu.

Click **Add** and complete the Add **OpenVPN Tunnel** screen.

Enter any descriptive name you wish to identify the OpenVPN Tunnel you are adding, for example NorthStOutlet-VPN.

Select the authentication method to be used. To authenticate using certificates, select **PKI (X.509 Certificates)** or select Custom Configuration to upload custom configuration files. Custom configurations must be stored in `/etc/config`.

Note: If you select PKI (public key infrastructure), you will need to establish:

- Separate certificate (also known as a public key). This Certificate File will be a *.cert file type
- Private Key for the server and each client. This Private Key File will be a *.key file type
- Primary Certificate Authority (CA) certificate and key, which is used to sign each of the server and client certificates. This Root CA Certificate will be a *.cert file type

4. Serial Port, Host, Device and User Configuration

For a server you may also need dh1024.pem (**Diffie Hellman** parameters). Refer to <http://openvpn.net/easyrsa.html> for a guide on basic RSA key management. For alternative authentication methods, go to <http://openvpn.net/index.php/documentation/howto.html#auth>. For more information, go to <http://openvpn.net/howto.html>.

- Select the **Device Driver** to be used, either **Tun-IP** or **Tap-Ethernet**. The TUN (network tunnel) and TAP (network tap) drivers are virtual network drivers that support IP tunneling and Ethernet tunneling, respectively. TUN and TAP are part of the Linux kernel.
- Select either **UDP** or **TCP** as the **Protocol**. UDP is the default and preferred protocol for OpenVPN.
- In **Tunnel Settings**, assign whether this is the **Client** or **Server** end of the tunnel. When running as a server, the advanced console server supports multiple clients connecting to the VPN server over the same port.
- Check or uncheck the **Compression** button to enable or disable compression.

Client Mode Details	
Primary Server Address	<input type="text"/> The address of the first server.
Primary Server Port	<input type="text" value="1194"/> The TCP/IP port of the first server. <i>Default is 1194.</i>
Secondary Server Address	<input type="text"/> The address of the second server (Optional).
Secondary Server Port	<input type="text" value="1194"/> The TCP/IP port of the second server (Optional). <i>Default is 1194.</i>

4.9.2 Configure as Server or Client

Complete the **Client Details** or **Server Details**, depending on the Tunnel Mode selected.

- If **Client** has been selected, the Primary Server Address will be the address of the OpenVPN Server.
- If **Server** has been selected, enter the IP Pool Network address and the IP Pool Network mask for the IP Pool. The network defined by the IP Pool Network address/mask is used to provide the addresses for connecting clients.

Click **Apply** to save changes.

Add OpenVPN Tunnel	
Tunnel Name	<input type="text" value="SouthStOutlet-VPN"/> A descriptive name for the OpenVPN tunnel
Device Driver	<input type="text" value="Tun - IP"/> Select the tap or tun driver to use.
Protocol	<input type="text" value="UDP"/> Use a UDP or TCP protocol
Tunnel Mode	<input type="text" value="Server"/> Is this the Client or Server end of the tunnel.
Configuration Method	<input type="text" value="PKI (X.509 Certificates)"/> Authenticate using certificates or use a custom configuration
Compression	<input checked="" type="checkbox"/> Enable or disable compression
Server Details	
Local Port	<input type="text"/> The TCP/IP port to listen on. <i>Default is 1194.</i>
IP Pool Network	<input type="text" value="10.100.0.0"/> Network addresses to allocate.
IP Pool Netmask	<input type="text" value="255.255.255.0"/> Network mask for IP Pool.
<input type="button" value="Apply"/>	

4. Serial Port, Host, Device and User Configuration

To enter authentication certificates and files, **Edit** the OpenVPN tunnel.

Select the **Manage OpenVPN Files** tab. Upload or browse to relevant authentication certificates and files.

Manage OpenVPN Files				
Configuration File	<input type="text"/>	<input type="button" value="Browse..."/>	File is not custom	NorthStOutlet-VPN.conf
Root CA Certificate	<input type="text" value="ear\Testing\Certificates\ca.crt"/>	<input type="button" value="Browse..."/>	<input type="button" value="Upload"/>	No file available
Certificate File	<input type="text" value="ing\Certificates\acm-client.crt"/>	<input type="button" value="Browse..."/>	<input type="button" value="Upload"/>	No file available
Private Key File	<input type="text" value="g\Certificates\acm-client.key"/>	<input type="button" value="Browse..."/>	<input type="button" value="Upload"/>	No file available
Diffie-Hellman File	<input type="text"/>	<input type="button" value="Browse..."/>	<input type="button" value="Upload"/>	No file available
<input type="button" value="Apply"/>				

Click **Apply** to save changes. Saved files will be displayed in red on the right-hand side of the Upload button.

Manage OpenVPN Files				
Configuration File	<input type="text"/>	<input type="button" value="Browse..."/>	File is not custom	NorthStOutlet-VPN.conf
Root CA Certificate	<input type="text"/>	<input type="button" value="Browse..."/>	<input type="button" value="Upload"/>	NorthStOutlet-VPN-ca.crt
Certificate File	<input type="text"/>	<input type="button" value="Browse..."/>	<input type="button" value="Upload"/>	NorthStOutlet-VPN-public.crt
Private Key File	<input type="text"/>	<input type="button" value="Browse..."/>	<input type="button" value="Upload"/>	NorthStOutlet-VPN-private.key
Diffie-Hellman File	<input type="text"/>	<input type="button" value="Browse..."/>	<input type="button" value="Upload"/>	No file available
<input type="button" value="Apply"/>				

4. Serial Port, Host, Device and User Configuration

To enable OpenVPN, **Edit** the OpenVPN tunnel.

OpenVPN Tunnels						
Tunnel Name	Tunnel Mode	Configuration Method	Protocol	Details	Enabled	
NorthStOutlet-VPN	Client	PKI (X.509)	udp	Server(s): 192.168.250.106:1194	<input type="checkbox"/>	Edit Delete

[Add](#)

Check the **Enabled** button.

Click **Apply** to save changes.

Note: Please make sure that the console server system time is correct when working with OpenVPN. Otherwise, authentication issues may arise.

Edit OpenVPN Tunnel Details

Tunnel Name **NorthStOutlet-VPN**
A descriptive name for the OpenVPN tunnel

Enabled Enable or disable the tunnel

Device Driver Tun - IP
Select the tap or tun driver to use.

Protocol UDP
Use a UDP or TCP protocol

Tunnel Mode Client
Is this the Client or Server end of the tunnel.

Configuration Method PKI (X.509 Certificates)
Authenticate using certificates or use a custom configuration

Compression Enable or disable compression

Select **Statistics** on the **Status** menu to verify that the tunnel is operational.

Interfaces	Routes	Serial Ports	IP	ICMP	TCP	UDP
eth0			Link encap:Ethernet HWaddr 00:10:A1:96:92:05 inet addr:192.168.0.1 Bcast:192.168.0.255 Mask:255.255.255.0 inet6 addr: fe80::210:a1ff:fe96:9205/64 Scope:Link UP BROADCAST RUNNING MULTICAST MTU:1500 Metric:1 RX packets:2616 errors:0 dropped:0 overruns:0 frame:0 TX packets:1565 errors:0 dropped:0 overruns:0 carrier:0 collisions:0 txqueuelen:1000 Interrupt:12 Memory:1fff8000-1fff80ff			
eth0:0			Link encap:Ethernet HWaddr 00:10:A1:96:92:05 inet addr:192.168.250.111 Bcast:192.168.250.255 Mask:255.255.255.0 UP BROADCAST RUNNING MULTICAST MTU:1500 Metric:1 Interrupt:12 Memory:1fff8000-1fff80ff			
lo			Link encap:Local Loopback inet addr:127.0.0.1 Mask:255.0.0.0 inet6 addr: ::1/128 Scope:Host UP LOOPBACK RUNNING MTU:16436 Metric:1 RX packets:975 errors:0 dropped:0 overruns:0 frame:0 TX packets:975 errors:0 dropped:0 overruns:0 carrier:0 collisions:0 txqueuelen:0			
tun0			Link encap:UNSPEC HWaddr 00-00-00-00-00-00-00-00-00-00-00-00-00-00-00-00-00 inet addr:10.100.0.6 P-t-P:10.100.0.5 Mask:255.255.255.255 UP POINTOPOINT RUNNING NOARP MULTICAST MTU:1500 Metric:1 RX packets:0 errors:0 dropped:0 overruns:0 frame:0 TX packets:0 errors:0 dropped:0 overruns:0 carrier:0 collisions:0 txqueuelen:100			

4. Serial Port, Host, Device and User Configuration

4.9.3 Set Up Windows OpenVPN Client and Server

Windows does not come standard with any OpenVPN server or client. This section outlines the installation and configuration of a Windows OpenVPN client or a Windows OpenVPN server and setting up a VPN connection to a console server.

Console servers with firmware version 3.5.2 and later will generate Windows client configurations automatically from the GUI for **Pre-shared Secret (Static Key File)** configurations.

Edit OpenVPN Tunnel Details		Manage OpenVPN Files	
Manage OpenVPN Files			
Configuration File	<input type="button" value="Choose File"/> No file chosen	File is not custom	ww.conf
Root CA Certificate	<input type="button" value="Choose File"/> No file chosen	File is not custom	No file available
Certificate File	<input type="button" value="Choose File"/> No file chosen	File is not custom	No file available
Private Key File	<input type="button" value="Choose File"/> No file chosen	File is not custom	No file available
Diffie-Hellman File	<input type="button" value="Choose File"/> No file chosen	File is not custom	No file available
Static Key File	<input type="button" value="Choose File"/> No file chosen	<input type="button" value="Upload"/>	ww-static.key
Client Configuration File	<input type="button" value="Choose File"/> No file chosen	File is not custom	ww-client.ovpn <small>Note: The 'remote UNDEFINED' setting in this config file must be fixed before use.</small>
Client Configuration Zip	<input type="button" value="Choose File"/> No file chosen	File is not custom	ww-client.zip <small>Contains both the Client Configuration File and the Static Key File.</small>

Alternately, OpenVPN GUI for Windows software (which includes the standard OpenVPN package, plus a Windows GUI) can be downloaded from <http://openvpn.se/download.html>.

- Once installed on the Windows machine, an OpenVPN icon will have been created in the Notification Area located in the right side of the taskbar. Right click on this icon to start (and stop) VPN connections, edit configurations and view logs.

When the OpenVPN software is running, the **C:\Program Files\OpenVPN\config** folder will be scanned for “.ovpn” files. This folder will be rechecked for new configuration files whenever the OpenVPN GUI icon is right clicked. Once OpenVPN is installed, a configuration file will need to be created:

- Using a text editor, create an **xxxx.ovpn** file and save in **C:\Program Files\OpenVPN\config**. For example, **C:\Program Files\OpenVPN\config\client.ovpn**.

An example of an OpenVPN Windows client configuration file is shown below:

```
# description: B098_client
client
proto udp
verb 3
dev tun
remote 192.168.250.152
port 1194
ca c:\openvpnkeys\ca.crt
cert c:\openvpnkeys\client.crt
key c:\openvpnkeys\client.key
nobind
persist-key
persist-tun
comp-lzo
```

4. Serial Port, Host, Device and User Configuration

An example of an OpenVPN Windows Server configuration file is shown below:

```
server 10.100.10.0 255.255.255.0
port 1194
keepalive 10 120
proto udp
mssfix 1400
persist-key
persist-tun
dev tun
ca c:\openvpnkeys\ca.crt
cert c:\openvpnkeys\server.crt
key c:\openvpnkeys\server.key
dh c:\openvpnkeys\dh.pem
comp-lzo
verb 1
syslog BO98_OpenVPN_Server
```

The Windows client/server configuration file options are:

Options	Description
#description:	This is a comment describing the configuration. Comment lines start with “#” and are ignored by OpenVPN.
Client server	Specify whether this will be a client or server configuration file. In the server configuration file, define the IP address pool and netmask. For example, server 10.100.10.0 255.255.255.0.
proto udp proto tcp	Set the protocol to UDP or TCP. The client and server must use the same settings.
mssfix <max. size>	Mssfix sets the maximum size of the packet. This is only useful for UDP if problems occur.
verb <level>	Set log file verbosity level. Log verbosity level can be set from 0 (minimum) to 15 (maximum). For example, 0 = silent except for fatal errors 3 = medium output, good for general usage 5 = helps with debugging connection problems 9 = extremely verbose, excellent for troubleshooting
dev tun dev tap	Select dev tun to create a routed IP tunnel or dev tap to create an Ethernet tunnel. The client and server must use the same settings.
remote <host>	The hostname/IP of OpenVPN server when operating as a client. Enter either the DNS hostname or the static IP address of the server.
Port	The UDP/TCP port of the server.
Keepalive	Keepalive uses ping to keep the OpenVPN session alive. “Keepalive 10 120” pings every 10 seconds and assumes the remote peer is down if no ping has been received over a 120 second time period.
http-proxy <proxy server> <proxy port #>	If a proxy is required to access the server, enter the proxy server DNS name or IP and port number.
ca <file name>	Enter the CA certificate file name and location. The same CA certificate file can be used by the server and all clients. Note: Ensure each “\” in the directory path is replaced with “\\”. For example, c:\openvpnkeys\ca.crt will become c:\\openvpnkeys\\ca.crt.
cert <file name>	Enter the client’s or server’s certificate file name and location. Each client should have its own certificate and key files. Note: Ensure each “\” in the directory path is replaced with “\\”.

4. Serial Port, Host, Device and User Configuration

Options	Description
key <file name>	Enter the file name and location of the client's or server's key. Each client should have its own certificate and key files. Note: Ensure each "\" in the directory path is replaced with "\\".
dh <file name>	This is used by the server only. Enter the path to the key with the Diffie-Hellman parameters.
Nobind	"Nobind" is used when clients do not need to bind to a local address or specific local port number. This is the case in most client configurations.
persist-key	This option prevents the reloading of keys across restarts.
persist-tun	This option prevents the close and reopen of TUN/TAP devices across restarts.
cipher BF-CBC Blowfish (default) cipher AES-128-CBC AES cipher DES-EDE3-CBC Triple-DES	Select a cryptographic cipher. The client and server must use the same settings.
comp-izo	Enable compression on the OpenVPN link. This must be enabled on both the client and the server.
syslog	By default, logs are located in syslog or, if running as a service on Window, in \ Program Files\OpenVPN\log directory.

To initiate the OpenVPN tunnel following the creation of the client/server configuration files:

- Right click on the **OpenVPN** icon in the Notification Area.
- Select the newly created client or server configuration. For example, B098_client.
- Right click on the **OpenVPN** icon in the lower-right corner, select the desired client and click **Connect**.
- The log file will display as the connection is established.

```

IM4216_client - Notepad
File Edit Format View Help
Fri Aug 06 11:29:57 2010 openvpn 2.0.9 win32-mingw [SSL] [LZO] built on Oct 1 2006
Fri Aug 06 11:29:57 2010 WARNING: No server certificate verification method has been enabled. See http://openvpn.net/
Fri Aug 06 11:29:57 2010 LZO compression initialized
Fri Aug 06 11:29:57 2010 control Channel MTU parms [ L:1542 D:138 EF:38 EB:0 ET:0 EL:0 ]
Fri Aug 06 11:29:57 2010 Data Channel MTU parms [ L:1542 D:1450 EF:42 EB:135 ET:0 EL:0 AF:3/1 ]
Fri Aug 06 11:29:57 2010 Local Options hash (VER=V4): '41690919'
Fri Aug 06 11:29:57 2010 Expected Remote Options hash (VER=V4): '530fdded'
Fri Aug 06 11:29:57 2010 UDPv4 link local: [undef]
Fri Aug 06 11:29:57 2010 UDPv4 link remote: 192.168.250.152:1194
Fri Aug 06 11:29:57 2010 TLS: Initial packet from 192.168.250.152:1194, sid=dd3359de 265f251d
Fri Aug 06 11:30:01 2010 VERIFY OK: depth=1, /C=US/ST=CA/L=SanFrancisco/O=Fort-Funston/CN=openVPN-CA/emailAddress=me@
Fri Aug 06 11:30:01 2010 VERIFY OK: depth=0, /C=US/ST=CA/L=SanFrancisco/O=Fort-Funston/CN=server/emailAddress=me@myhos
Fri Aug 06 11:30:02 2010 Data Channel Encrypt: Cipher 'BF-CBC' initialized with 128 bit key
Fri Aug 06 11:30:02 2010 Data Channel Encrypt: Using 160 bit message hash 'SHA1' for HMAC authentication
Fri Aug 06 11:30:02 2010 Data Channel Decrypt: Cipher 'BF-CBC' initialized with 128 bit key
Fri Aug 06 11:30:02 2010 Data Channel Decrypt: Using 160 bit message hash 'SHA1' for HMAC authentication
Fri Aug 06 11:30:02 2010 Control Channel: TLSv1, cipher TLSv1/SSLv3 DHE-RSA-AES256-SHA, 1024 bit RSA
Fri Aug 06 11:30:02 2010 [server] Peer connection initiated with 192.168.250.152:1194
Fri Aug 06 11:30:04 2010 SENT CONTROL [server]: 'PUSH_REQUEST' (status=1)
Fri Aug 06 11:30:04 2010 PUSH: Received control message: 'PUSH_REPLY,route 10.100.10.1,topology net30,ping 10,ping-res
Fri Aug 06 11:30:04 2010 Options error: Unrecognized option or missing parameter(s) in [PUSH-OPTIONS]:2: topology (2.0
Fri Aug 06 11:30:04 2010 OPTIONS IMPORT: timers and/or timeouts modified
Fri Aug 06 11:30:04 2010 OPTIONS IMPORT: --ifconfig/up options modified
Fri Aug 06 11:30:04 2010 OPTIONS IMPORT: route options modified
Fri Aug 06 11:30:04 2010 TAP-WIN32 device [Local Area Connection 3] opened: \\.\Global\{12EF532A-3135-4F37-B689-720FE0
Fri Aug 06 11:30:04 2010 TAP-WIN32 Driver Version 8.4
Fri Aug 06 11:30:04 2010 TAP-WIN32 MTU=1500
Fri Aug 06 11:30:04 2010 Notified TAP-win32 driver to set a DHCP IP/netmask of 10.100.10.6/255.255.255.252 on interfac
Fri Aug 06 11:30:04 2010 Successful ARP Flush on interface [5] {12EF532A-3135-4F37-B689-720FE0B1F713}
Fri Aug 06 11:30:04 2010 TEST ROUTES: 0/0 succeeded len=1 ret=0 a=0 u/d=down
Fri Aug 06 11:30:04 2010 Route: waiting for TUN/TAP interface to come up...
Fri Aug 06 11:30:05 2010 TEST ROUTES: 0/0 succeeded len=1 ret=0 a=0 u/d=down
Fri Aug 06 11:30:05 2010 Route: waiting for TUN/TAP interface to come up...
Fri Aug 06 11:30:06 2010 TEST ROUTES: 1/1 succeeded len=1 ret=1 a=0 u/d=up
Ln 1, Col 1

```

4. Serial Port, Host, Device and User Configuration

- Once established, the OpenVPN icon will display a message notifying the successful connection and assigned IP. This information, as well as the time the connection was established, is available anytime by scrolling over the OpenVPN icon.

Note: An alternate OpenVPN Windows client can be downloaded from <http://www.openvpn.net/index.php/openvpn-client/downloads.html>. Refer to <http://www.openvpn.net/index.php/openvpn-client/howto-openvpn-client.html> for help.



4.10 PPTP VPN

Console servers with firmware version 3.5.2 and later include a PPTP (Point-to-Point Tunneling Protocol) server. PPTP is typically used for communications over a physical or virtual serial link. The PPP endpoints define a virtual IP address to themselves. Routes to networks can then be defined with these IP addresses as the gateway, which results in traffic being sent across the tunnel. PPTP establishes a tunnel between the physical PPP endpoints and securely transports data across the tunnel.

The strength of PPTP is its ease of configuration and integration into existing Microsoft infrastructure. It is generally used for connecting single remote Windows clients. If you take your portable computer on a business trip, you can dial a local number to connect to your Internet access service provider (ISP) and then create a second connection (tunnel) into your office network across the Internet and have the same access to your corporate network as if you were connected directly from your office. Similarly, telecommuters also set up a VPN tunnel over their cable modem or DSL links to their local ISP.

To set up a PPTP connection from a remote Windows client to your Tripp Lite console server and local network:

1. Enable and configure the PPTP VPN server on your Tripp Lite console server.
2. Set up VPN user accounts on the Tripp Lite console server and enable the appropriate authentication.
3. Configure the VPN clients at the remote sites. The client does not require special software as the PPTP Server supports the standard PPTP client software included with Windows NT and later.
4. Connect to the remote VPN.

4. Serial Port, Host, Device and User Configuration

4.10.1 Enable the PPTP VPN Server

Select **PPTP VPN** on the **Serial & Networks** menu.



System Name: b093-008-2e4u-v Model: B093-008-2E4U-V Firmware: 4.0.0u1
Uptime: 1 days, 20 hours, 18 mins, 20 secs Current User: root



Serial & Network: PPTP VPN

- Manage
- Status
- Serial & Network
 - Serial Port
 - Users & Groups
 - Authentication
 - Network Hosts
 - Trusted Networks
 - IPsec VPN
 - OpenVPN
 - PPTP VPN
 - Cascaded Ports
 - UPS Connections
 - RPC Connections
 - Environmental
 - Managed Devices
 - IP Passthrough
- Alerts & Logging
- System
 - Administration
 - SSL Certificates
 - Configuration Backup
 - Firmware
 - IP
 - Date & Time
 - Dial
 - Firewall
 - Services
 - DHCP Server
 - Nagios
 - Configure Dashboard
 - Digital I/O

PPTP Server

Enable Enable the PPTP server.

Minimum Authentication Required None (least secure)
 PAP
 CHAP
 MSCHAPv2 (most secure)
The least secure method to use when checking the PPTP user's credentials.

Required Encryption Level Only no encryption (also disables compression)
 40bit or 128bit encryption
 Only 40bit encryption
 Only 128bit encryption
 Any encryption (including none)
The encryption to require for the PPTP connection.

Local Address
IP address to assign to the server's end of the VPN connection.

Remote Addresses
Pool of IP addresses to assign to the incoming client's VPN connections e.g. 192.168.1.10-20

MTU
Maximum transmission unit of the PPTP interface. Defaults to 1400.

DNS Server
Optional IP address of a DNS server to hand to incoming clients

WINS Server
Optional IP address of a WINS server to hand to incoming clients

Verbose logging Enable verbose logging to assist in debugging connection problems

Authenticated PPTP VPN Connections

Select the **Enable** check box to enable the PPTP Server.

Select the **Minimum Authentication Required**. Access is denied to remote users attempting to connect using an authentication scheme weaker than the selected scheme. The schemes are described below, from strongest to weakest.

- **Encrypted Authentication (MS-CHAP v2):** This is the strongest type of authentication to use and is the recommended option.
- **Weakly Encrypted Authentication (CHAP):** This is the weakest type of encrypted password authentication to use. It is not recommended that clients connect using this as it provides very little password protection. Also, note that clients connecting using CHAP are unable to encrypt traffic.
- **Unencrypted Authentication (PAP):** This is plain text password authentication. When using this type of authentication, the client password is transmitted unencrypted.
- **None.**

Select the **Required Encryption Level**. Access is denied to remote users attempting to connect not using this encryption level. Strong **40-bit** or **128-bit** encryption is recommended.

In **Local Address**, enter the IP address to assign to the server's end of the VPN connection.

In **Remote Addresses**, enter the pool of IP addresses to assign to the incoming client's VPN connections (e.g. 192.168.1.10-20). This must be a free IP address (or a range of free IP addresses), from the network (typically the LAN) that remote users are assigned while connected to the Tripp Lite console server.

Enter the desired value of the Maximum Transmission Unit (MTU) for the PPTP interfaces into the **MTU** field (defaults to 1400).

4. Serial Port, Host, Device and User Configuration

In the **DNS Server** field, enter the IP address of the DNS server that assigns IP addresses to connecting PPTP clients. In the **WINS Server** field, enter the IP address of the WINS server that assigns IP addresses to connecting PPTP client. Enable **Verbose Logging** to assist in debugging connection problems.

Click **Apply** Settings.

4.10.2 Add a PPTP User

Select **Users & Groups** on the **Serial & Networks** menu, and complete the fields as covered in section **4.2 Add and Edit Users**.

Ensure the pptpd **Group** has been checked to allow access to the PPTP VPN server.

Note: Users in this group will have their password stored in plain text.

Keep a note of the username and password for when you need to connect to the VPN connection.

Click **Apply**.



System Name: b093-008-2e4u-v Model: B093-008-2E4U-V Firmware: 4.0.0u1
Uptime: 1 days, 20 hours, 19 mins, 54 secs Current User: root



Serial & Network: Users & Groups

- Manage
- Status
- Serial & Network
 - Serial Port
 - Users & Groups
 - Authentication
 - Network Hosts
 - Trusted Networks
 - IPsec VPN
 - OpenVPN
 - PPTP VPN
 - Cascaded Ports
 - UPS Connections
 - RPC Connections
 - Environmental
 - Managed Devices
 - IP Passthrough
- Alerts & Logging
- System
 - Administration
 - SSL Certificates
 - Configuration Backup
 - Firmware
 - IP
 - Date & Time

Add a New user

Username
A unique name for the user.

Description
A brief description of the user's role.

Groups

- admin (Provides users with unlimited configuration and management privileges)
- pptpd (Group to allow access to the PPTP VPN server - Users in this group will have their password stored in clear text.)
- dialin (Group to allow dialin access via modems - Users in this group will have their password stored in clear text.)
- ftp (Group to allow ftp access and file access to storage devices)
- pmsshell (Group to set default shell to pmsshell)
- pmoperator (Group to allow access to all serial ports and managed devices, including portmanager shell access. Please note that portmanager shell access overrides UNIX shell access)
- users (Provides users with basic management privileges)

A group with predefined privileges the user will belong to.

Password
The users authentication secret. *Note: A password may not be required if remote authentication is being used.*

Confirm
Re-enter the users password for confirmation.

4. Serial Port, Host, Device and User Configuration

4.10.3 Set Up a Remote PPTP Client

Ensure the remote VPN client PC has Internet connectivity. To create a VPN connection across the Internet, you must set up two networking connections. One connection is for the ISP and the other connection is for the VPN tunnel to the Tripp Lite console server.

Note: This procedure sets up a PPTP client in the Windows 7 Professional operating system. The steps may vary slightly depending on your network access or if you are using an alternate version of Windows. More detailed instructions are available from the Microsoft web site.

Log in to your Windows client with administrator privileges.

From the **Network & Sharing Center** on the Control Panel, select **Network Connections** and create a new connection.

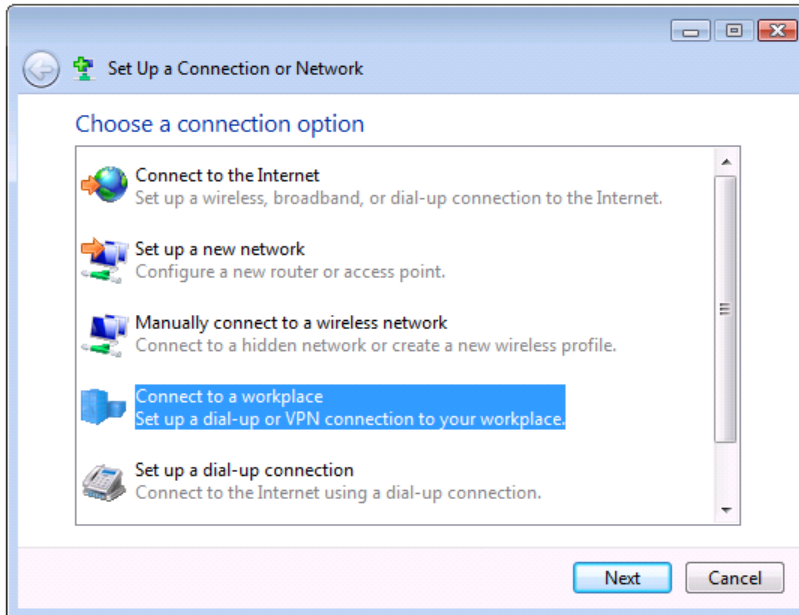

Select **Use My Internet Connection (VPN)** and enter the IP Address of the Tripp Lite console server.

Note: To connect remote VPN clients to the local network, you need to know the user name and password for the PPTP account you added, as well as the Internet IP address of the Tripp Lite console server. If your ISP has not allocated you a static IP address, consider using a dynamic DNS service. Otherwise, you must modify the PPTP client configuration each time your Internet IP address changes.

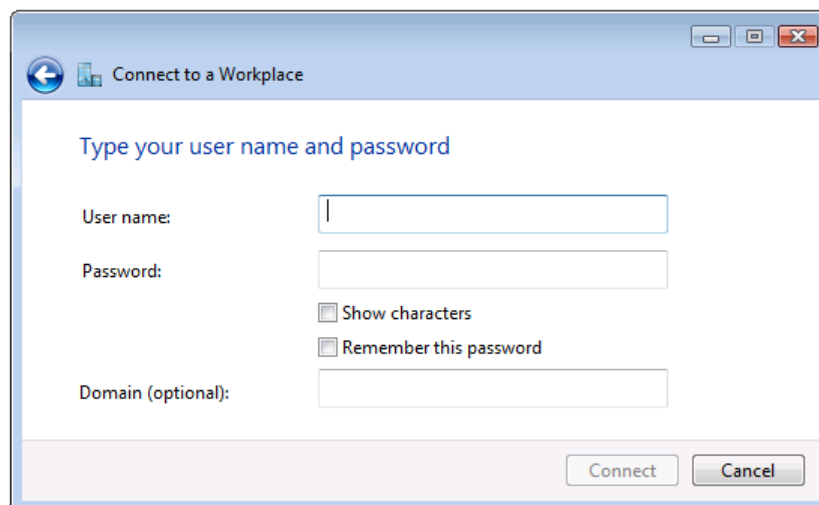

4. Serial Port, Host, Device and User Configuration

4.11 IP Passthrough

IP passthrough is used to make a modem connection (e.g., Tripp Lite's internal cellular modem) appear as a regular Ethernet connection to a third-party downstream router. This allows the downstream router to use Tripp Lite's modem connection as a primary or backup WAN interface.

The console server provides the modem IP address and DNS details to the downstream device over DHCP and transparently passes network traffic to and from the modem and router.

While IP passthrough essentially turns a console server into a modem-to-Ethernet half-bridge, some specific layer 4 services (HTTP/HTTPS/SSH) may still be terminated at the console server (**Service Intercepts**). Also, services running on the console server can initiate outbound cellular connections independent of the downstream router.

This allows the console server to continue to be used for out-of-band management and alerts while in IP passthrough mode.

4.11.1 Downstream Router Setup

To use failover connectivity on the downstream router (Failover to Cellular or F2C), it must have two or more WAN interfaces.

Note: Failover in IP passthrough context is performed entirely by the downstream router. The built-in, out-of-band failover logic on the console server itself is not available while in IP passthrough mode.

Connect an Ethernet WAN interface on the downstream router to the network interface or management LAN port with an Ethernet cable.

Configure this interface on the downstream router to receive its network settings via DHCP. If failover is required, configure the downstream router for failover between its primary interface and the Ethernet port connected to the console server.

4.11.2 IP Passthrough Pre-Configuration

To enable IP passthrough:

- Configure the network interface and (where applicable) management LAN interfaces with static network settings
 - o Click **Serial & Network: IP**.
 - o For network interface and (where applicable) management LAN, select **Static** for the **Configuration Method** and enter the network settings (see section **3.3 Network Connection** for more information).
 - o For the interface connected to the downstream router, you may choose any dedicated private network. The chosen network will only exist between the console server and downstream router and will not normally be accessible.
 - o For the other interface, configure it as you would per normal on the local network.
 - o For both interfaces, leave **Gateway** blank.
- Configure the modem in Always On Out-of-band mode
 - o For a cellular connection, click **System: Dial: Internal Cellular Modem**.
 - o Select **Enable Dial-Out** and enter carrier details such as **APN** (see section **5.6 Cellular Modem Connection** for more information).

4. Serial Port, Host, Device and User Configuration

4.11.3 IP Passthrough Configuration

To configure IP passthrough:

- Click **Serial & Network: IP Passthrough** and check **Enable**.
- Select the **Modem** to use for upstream connectivity.
- Optionally, enter the **MAC Address** of downstream router's connected interface.

Note: If the MAC address is not specified, the console server will pass through to the first downstream device requesting a DHCP address.

- Select the **Ethernet Interface** to use for connectivity to the downstream router.
- Click **Apply**.

The screenshot shows a configuration page for IP Passthrough. It is divided into three main sections: Configuration, Status, and Service Intercepts.

Configuration Section:

- Enable:** A checked checkbox with the text "Enable IP passthrough from modem to downstream router".
- Modem:** A dropdown menu set to "Internal Cellular Modem" with the description "Modem to use for upstream connectivity".
- MAC Address:** An empty text input field with the description "Ethernet hardware address of downstream router".
- Interface:** A dropdown menu set to "Management LAN" with the description "Ethernet interface used to communicate to downstream router".
- Enable Force Subnet Mask:** An unchecked checkbox with the description "Manually specify the network mask provided to the downstream router".
- Force Subnet Mask:** A text input field containing "24" with the description "Manual network mask in CIDR notation without the leading slash, e.g. 24".

Status Section:

- IP Passthrough:** Starting
- External IP Address:** (Empty)
- Internal MAC Address:** (Empty)
- Modem:** Disabled (Internal Cellular Modem) [Configure](#)
- DHCP Server:** Stopped

Service Intercepts Section:

Service Name	Service Enabled	Intercept Enabled	Intercept Port
HTTP Web Management	Enabled	<input type="checkbox"/>	80 <input type="text"/>
HTTPS Web Management	Enabled	<input type="checkbox"/>	443 <input type="text"/>
SSH Command Shell	Enabled	<input type="checkbox"/>	22 <input type="text"/>

An "Apply" button is located at the bottom left of the configuration section.

4.11.4 Service Intercepts

These allow the console server to continue to provide services for out-of-band management when in IP passthrough mode. Connections to the modem address on the specified intercept port(s) will be handled by the console server, rather than being passed through to the downstream router.

- For the required service of **HTTP**, **HTTPS** or **SSH**, check **Enable**.
- Optionally modify the **Intercept Port** to an alternate port (e.g. 8443 for HTTPS). This is useful if you want to continue to allow the downstream router to remain accessible via its regular port.

4.11.5 IP Passthrough Status

Refresh the page to view the **Status** section. It displays the modem's **External IP Address** being passed through, the **Internal MAC Address** of the downstream router (only populated when the downstream router accepts the DHCP lease), and the overall running status of the **IP passthrough** service.

Additionally, you may be alerted to the failover status of the downstream router by configuring a **Routed Data Usage Check** under **Alerts & Logging: Auto-Response**.

4. Serial Port, Host, Device and User Configuration

4.11.6 Caveats

Some downstream routers may be incompatible with the gateway route. This may happen when IP passthrough is bridging a 3G cellular network where the gateway address is a point-to-point destination address and no subnet information is available. The console server sends a DHCP netmask of 255.255.255.255. Devices will normally interpret this as a “single host route” on the interface, but as this is an unusual setting for Ethernet, some older downstream devices may encounter issues.

Intercepts for local services will not work if the console server is using a default route other than the modem. As per normal operation, they will also not work unless the service is enabled and access to the service is enabled (see **System: Services: Service Access: Dial-Out/Cellular**).

Outbound connections originating from the console server to remote services are supported (e.g. sending SMTP email alerts, SNMP traps, getting NTP time, IPSec tunnels). There is a minor risk of connection failure should both the console server and the downstream device try to access the same UDP or TCP port on the same remote host and at the same time where they have randomly chosen the same originating local port number.

5. Firewall, Failover and OOB Access

To ensure high availability, the console server has a number of out-of-band access capabilities and transparent failover features. If there is difficulty in accessing the console server through the main network path, all console server models provide out-of-band (OOB) access and the Administrator can still access it (and its Managed Devices) from a remote location.

- All console server models support serially attaching an external dial-up modem and configuring dial-in OOB access. Some models with USB ports support attaching an external USB modem. Some models also come standard with an internal modem. These modems can also be configured for dial-in OOB access.
- All console server models with an internal or external attached modem (and firmware version 3.4 or later) can be configured for out-dial to be permanently connected.
- The advanced console server models can also be configured for transparent out-dial failover. In the event of a disruption in the principal management network, an external dial-up ppp connection is automatically established.
- These advanced console server models can also be accessed out-of-band using an alternate broadband link and offer transparent broadband failover.
- Models with an internal cellular modem can be configured for OOB cellular access, cellular transparent failover, or as a cellular router.

5.1 Dialup Modem Connection

To enable dial-in or dial-out, first ensure there is a modem attached to the console server.

- All models support external USB modems. The USB modem will be auto-detected and an **External USB Modem Port** tab will appear under **System -> Dial** (in addition to the **Serial DB9 Port** tab). All console server models supports an external modem (any brand) attached via a serial cable to the console/modem port for OOB dial-in access.
- The serial ports on the B093 are by default configured as RJ serial console server ports. However, Port 1 can be configured to be the local console/modem port.

5.2 OOB Dial-In Access

Once a modem has been attached to the console server, you can configure the console server for dial-in PPP access. The console server will then await an incoming connection from a dial-in at remote site. Next, the remote client dial-in software needs to be configured to establish the connection between the Administrator's client modem to the dial-in modem on the console server.

5. Firewall, Failover and OOB Access

5.2.1 Configure Dial-In PPP

Enable PPP access on the internal or externally attached modem:

- Select the System: Dial menu option and the port to be configured (Serial DB9 Port, Internal Modem Port or External USB Port).
- Select the Baud Rate and Flow Control that will communicate with the modem.

Note: By default, the modem port on all Tripp Lite console servers is set with software flow control. The baud rate is set at:

- 115200 for external modems connected to the local console port on B098 console servers.
- 9600 for the internal modem or external USB modem and for external modems connected to the console serial ports, which have been reassigned for dial-in access (on B093).

When enabling OOB dial-in, it is recommended the Serial Setting be changed to 38400 baud with Hardware Flow Control.



System Name: b093-008-2e4u-v Model: B093-008-2E4U-V Firmware: 4.0.0u1
Uptime: 1 days, 20 hours, 26 mins, 8 secs Current User: root



The screenshot shows the 'System: Dial' configuration page. The sidebar menu is expanded to 'System', showing options like Administration, SSL Certificates, Configuration Backup, Firmware, IP, Date & Time, Dial, Firewall, Services, DHCP Server, Nagios, Configure Dashboard, and Digital I/O. The main content area is titled 'Serial DB9 Port' and contains the following settings:

- Serial DB9 Port Dial Settings:**
 - Disable Dial:** Disable modem communication.
 - Enable Dial-In:** Allow incoming modem communication.
 - Enable Dial-Out:** Allow outgoing modem communication.
- Serial Settings:**
 - Baud Rate:** 115200 (dropdown menu). The port speed in characters per second.
 - Flow Control:** None (dropdown menu). The method of flow control to use.

An 'Apply Modem Dial Settings' button is located at the bottom of the settings area.

Note: You can further configure the console/modem port (e.g. to include modem init strings) by editing `/etc/mgetty.config` files as described in **14. Configuration from the Command Line**.

- Check the **Enable Dial-In Access** box.
- In the **Remote Address** field, enter the IP address to be assigned to the dial-in client. You can select any address for the Remote IP Address. However, it must be in the same network range as the Local IP Address (e.g., 200.100.1.12 and 200.100.1.67).
- In the **Local Address** field, enter the IP address for the Dial-In PPP Server. This IP address will be used by the remote client to access the console server once the modem connection is established. You can select any address for the Local IP Address, but it must both be in the same network range as the Remote IP Address.
- The **Default Route** option enables the dialed PPP connection to become the default route for the console server.
- The **Custom Modem Initialization** option allows a custom AT string modem initialization string to be entered (e.g. AT&C1&D3&K3).

5. Firewall, Failover and OOB Access

System: Dial

Serial & Network

- » Serial Port
- » Users & Groups
- » Authentication
- » Network Hosts
- » Trusted Networks
- » IPsec VPN
- » OpenVPN
- » PPTP VPN
- » Call Home
- » Cascaded Ports
- » UPS Connections
- » RPC Connections
- » Environmental
- » Managed Devices

Alerts & Logging

- » Port Log
- » Auto-Response
- » SMTP & SMS
- » SNMP

System

- » Administration
- » SSL Certificates
- » Configuration Backup
- » Firmware
- » IP
- » Date & Time
- » Dial
- » Firewall
- » DHCP Server
- » Nagios
- » Configure Dashboard

Status

- » Port Access
- » Active Users
- » Statistics
- » Support Report
- » Syslog
- » UPS Status
- » RPC Status
- » Environmental Status
- » Power Supply Status
- » Dashboard

Manage

- » Devices
- » Port Logs
- » Host Logs
- » Power
- » Terminal

Serial DB9 Port
Internal Modem

Internal Modem Dial Settings

Disable Dial Disable modem communication.

Enable Dial-In Allow incoming modem communication.

Enable Dial-Out Allow outgoing modem communication.

Serial Settings

Baud Rate
The port speed in characters per second.

Flow Control
The method of flow control to use.

Dial-In Settings

Remote Address
The IP address to assign a dial-in client.

Local Address
The IP address for the dial-in server.

Default Route
The dialed connection is to become a default route for the system.

Custom Modem Initialization
An optional AT command sequence to initialize the modem.

Authentication Type
 None (least secure)
 PAP
 CHAP
 MSCHAPv2 (most secure)
 The method to use when checking the dial-in users credentials.

Required Encryption Level
 Only no encryption (also disables compression)
 40bit or 128bit encryption
 Only 40bit encryption
 Only 128bit encryption
 Any encryption (including none)
 The encryption to require for the dial-in connection.

Dynamic DNS

Dynamic DNS
Update a DNS server when IP address is changed.

DDNS server
The DDNS server to push updates to.
The format is server address:port
This is used by gnuddp only

DDNS Hostname
The fully qualified DNS hostname assigned to this interface.

DDNS Username
The username for the account to manage this interface.

DDNS Password
The password for the account to manage this interface.

Confirm DDNS Password
Re-enter the password for confirmation.

Maximum interval between updates
Maximum interval between updates in days. DDNS update will be sent even if the address has not changed. *Defaults to 25.*

Minimum interval between checks
Minimum interval between checks for changed addresses, in seconds. Updates will still only be sent if the address has changed. *Defaults to 1800.*

Maximum attempts per update
Number of times to attempt an update before giving up. *Defaults to 3.*

5. Firewall, Failover and OOB Access

- Select the **Authentication Type** required. Access is denied to remote users attempting to connect using an authentication scheme weaker than the selected scheme. The schemes are described below, from strongest to weakest.
 - o **Encrypted Authentication (MS-CHAP v2):** This is the strongest type of authentication to use and is the recommended option.
 - o **Weakly Encrypted Authentication (CHAP):** This is the weakest type of encrypted password authentication to use. It is not recommended that clients connect using this, as it provides very little password protection. Also, note that clients connecting using CHAP are unable to encrypt traffic.
 - o **Unencrypted Authentication (PAP):** This is plain text password authentication. When using this type of authentication, the client password is transmitted unencrypted.
 - o **None.**
- Select the **Required Encryption Level**. Access is denied to remote users attempting to connect not using this encryption level. Strong **40-bit** or **128-bit** encryption is recommended.

Notes:

*Firmware version 3.5.2 and beyond support multiple dial-in users with dial-in group membership. The **Username** and **Password** to be used for the dial-in PPP link, and any dial-back phone numbers are configured when the User is set up. Earlier firmware is only supported for one PPP dial-in account.*

*Section **13. Management** contains examples of Linux commands that can be used to control the modem port operation at the command line level.*

5.2.2 Using SDT Connector Client

Administrators can use their SDT connector client to set up secure OOB dial-in access to remote console servers. The SDT connector Java client software provides point-and-click secure remote access. OOB access uses an alternate path for connecting to the console server to that used for regular data traffic.

Starting an OOB connection in SDT connector may be achieved by initiating a dial-up connection, or adding an alternate route to the console server. SDT connector allows for maximum flexibility in this regard by allowing you to provide your own scripts or commands for starting and stopping the OOB connection. Refer **6.5 Using SDT Connector for Out-of-Band Connection to the Gateway** for more information.

5.2.3 Set Up Windows XP or Later Client

Open **Network Connections** in **Control Panel** and click the **New Connection Wizard**.

Select **Connect to the Internet** and click **Next**.

On the **Getting Ready** screen, select **Set up my connection manually** and click **Next**.

On the **Internet Connection** screen, select **Connect using a dial-up modem** and click **Next**.

Enter a **Connection Name** (any name you choose) and the dial-up **Phone number** that will connect to the console server modem.

Enter the PPP **Username** and **Password** to set up for the console server.

5. Firewall, Failover and OOB Access

5.2.4 Set Up Earlier Windows Clients

For Windows 2000, the PPP client set up procedure is the same as above, except you go to the **Dial-Up Networking Folder** by clicking the **Start** button and selecting **Settings**. Then click **Network and Dial-up Connections** and click **Make New Connection**.

Similarly, for Windows 98, double-click **My Computer** on the Desktop, then open **Dial-Up Networking**, double-click **Make New Connection** and proceed as above.

5.2.5 Set Up Linux Clients

The online tutorial <http://www.yolinux.com/TUTORIALS/LinuxTutorialPPP.html> presents a selection of methods for establishing a dial-up PPP connection:

- Command line PPP and manual configuration (which works with any Linux distribution).
- Using the **Linuxconf** configuration tool (for Red Hat compatible distributions). This configures the scripts **ifup/ifdown** to start and stop a PPP connection.
- Using the Gnome control panel configuration tool.
- WVDIAL and the Redhat "Dialup configuration tool".
- GUI dial program X-isp. Download/Installation/Configuration.

Note: For all PPP clients:

- Set the PPP link up with TCP/IP as the only protocol enabled.
- Specify the Server will assign IP address and do DNS.
- Do not set up the console server PPP link as the default for Internet connection.

5.3 Dial-Out Access

The internal or external attached modem on the console server can be set up in either:

- Failover mode, where a dial-out connection is only established in event of a **ping** failure
or
- With the dial-out connection always on.

In both of the above cases, during a disruption in the dial-out connection, the console server will work to re-establish the connection.

5. Firewall, Failover and OOB Access

5.3.1 Always-On Dial-Out

With firmware version 3.4 (and later), the console server modem can be configured for out-dial to be always on, with a permanent external dial-up ppp connection.

- Select the **System: Dial** menu option and check **Enable Dial-Out** to allow outgoing modem communications.
- Select the **Baud Rate** and **Flow Control** that will communicate with the modem.
- In the **Dial-Out Settings - Always On Out-of-Band** field, enter the access details for the remote PPP server to be called.

Override DNS is available for PPP Devices, such as modems. Override DNS allows the use of alternate DNS servers from those provided by your ISP. For example, an alternative DNS may be required for OpenDNS used for content filtering.

- To enable Override DNS, check the **Override Returned DNS Servers** box. Enter the IP of the DNS servers into the spaces provided.

System: Dial

Serial & Network

- Serial Port
- Users & Groups
- Authentication
- Network Hosts
- Trusted Networks
- Call Home
- Cascaded Ports
- UPS Connections
- RPC Connections
- Environmental
- Managed Devices

Alerts & Logging

- Port Log
- Alerts
- SMTP & SMS
- SNMP

System

- Administration
- SSL Certificates
- Configuration Backup
- Firmware
- IP
- Date & Time
- Dial
- Firewall
- Nagios
- Configure Dashboard

Status

- Port Access
- Active Users
- Statistics
- Support Report
- Syslog
- UPS Status
- RPC Status
- Environmental Status
- Dashboard

Manage

- Devices
- Port Logs
- Host Logs
- Power
- Terminal

Serial DB9 Port Dial Settings

Disable Dial Disable modem communication.

Enable Dial-In Allow incoming modem communication.

Enable Dial-Out Allow outgoing modem communication.

Serial Settings

Baud Rate 115200
The port speed in characters per second.

Flow Control None
The method of flow control to use.

Dial-Out Settings - Always On Out-of-Band

Phone Number
The phone number to call to establish the connection.

Username
The username for authentication.

Password
The secret to use when authenticating the user.

Confirm
Re-enter the user's password for confirmation.

Custom Modem Initialization
An optional AT command sequence to initialize the modem.

Ignore Dial Tone Do not wait for dial tone before dialing.

Override DNS

Override returned DNS servers Use the following DNS servers instead of the PPP provided servers.

DNS Server 1
The primary DNS server.

DNS Server 2
The secondary DNS server.

5. Firewall, Failover and OOB Access

5.3.2 Failover Dial-Out

The console servers can be configured so a dial-out PPP connection is automatically set up in the event of a disruption in the principal management network.

Note: Only SSH access is enabled on the failover connection. In firmware versions later than 3.0.2, HTTPS access is also enabled so the administrator can use SSH (or HTTPS) to connect to the console server and fix the problem.

When configuring the principal network connection in System: IP, specify the failover interface that will be used when a fault has been detected with Network / Network1 (eth0). This can be either internal modem or the dial serial DB9 (if you are using an external modem on the console port) or USB modem (if you are using a plug-in USB modem on a B093).

The screenshot shows the 'System: IP' configuration page. The left sidebar contains a tree view with categories: Serial & Network, Alerts & Logging, System, and Status. The main content area is titled 'IP Settings: Network' and includes tabs for 'Network Interface', 'Management LAN Interface', 'Out-of-Band/Failover Interface', 'General Settings', and 'Route Settings'. The 'Out-of-Band/Failover Interface' tab is active. The configuration includes fields for IP Address, Subnet Mask, Gateway, Primary DNS, and Secondary DNS. A 'Media' dropdown is set to 'Auto'. A 'DHCP Server' dropdown is open, showing options: 'None', 'Management LAN (lan) DISABLED', 'Out-of-Band/Failover (oobfo) DISABLED', and 'Serial DB9 Port (sercon) DISABLED'. The 'Failover Interface' dropdown is set to 'None'.

- Specify the Probe Addresses of two sites (the Primary and Secondary) that the IM console server is to ping to determine if Network / Network1 is still operational.
- Select the **System: Dial** menu option and the port to be configured (**Serial DB9 Port**, **PC Card** or **Internal Modem Port**).
- Select the **Baud Rate** and **Flow Control** that will communicate with the modem.

Note: You can further configure the console/modem port to include modem init strings by editing `/etc/mgetty.config` files as described in the **13. Management**.

- Check the **Enable Dial-Out Access** box and enter the access details for the remote PPP server.

5. Firewall, Failover and OOB Access

Override DNS is available for PPP devices, such as modems. Override DNS allows the use of alternate DNS servers from those provided by your ISP. For example, an alternative DNS may be required for OpenDNS used for content filtering.

- To enable **Override DNS**, check the **Override returned DNS Servers** box. Enter the IP of the DNS servers into the spaces provided.



System Name: b093-008-2e4u-v Model: B093-008-2E4U-V Firmware: 4.0.0u1
Uptime: 1 days, 20 hours, 37 mins, 1 secs Current User: root



System: Dial

Serial DB9 Port | Internal Cellular Modem

Carrier data charges apply while the cellular connection is active. We recommend configuring [Auto-Response Cellular Data](#) alerts and where possible monitoring data usage via your carrier's portal. Consider using Failover mode (under [IP -> Network Interface -> Failover](#)) to limit cellular activity.

Internal Cellular Modem Dial Settings

Disable Dial Disable modem communication.

Enable Dial-Out Allow outgoing modem communication.

Dial-Out Settings - Always On Out-of-Band

Control via Auto-Response Indicates that the connection will be controlled by "Network Interface" Auto-Response action. The default state for the connection will be *Down*

SIM Configuration

Primary SIM
The default SIM slot to use.

Enable SIM Failover Enable failover between the Primary SIM and the Secondary on connection failure.

SIM Failover Settings

Failback Method On Disconnect
 On Timeout
The method used to determine when to fail-back to the Primary SIM: either when the secondary SIM loses connection, or after a fixed time period.

Note: By default, the advanced console server supports automatic failure-recovery that reverts it back to its original state prior to failover (firmware version 3.1.0 and later). The advanced console server continually pings probe addresses while in original and failover states. The original state will automatically be set as a priority and reestablished following three successful pings of the probe addresses during failover. The failover state will be removed once the original state has been re-established.

5.4 OOB Broadband Ethernet Access

The console servers have a second Ethernet port that can be configured for alternate and OOB (out-of-band) broadband access. With two active broadband access paths to these advanced console servers, you can still access it through the alternate broadband path in the event you are unable to access through the primary management network (LAN1, Network or Network1).

- On the **System: IP** menu, select **Management LAN Interface** and configure the **IP Address**, **Subnet Mask**, **Gateway** and **DNS** with the access settings that relate to the alternate link.
- Ensure when configuring the principal **Network Interface** connection, the **Failover Interface** is set to **None**.

5. Firewall, Failover and OOB Access

5.5 Broadband Ethernet Failover

The second Ethernet port on the console servers can also be configured for failover to ensure transparent high availability.

The screenshot shows the 'System: IP' configuration page. On the left is a navigation menu with categories: Manage, Status, Serial & Network, Alerts & Logging, and System. The 'System' category is expanded to show sub-items like Administration, SSL Certificates, Configuration Backup, Firmware, IP, Date & Time, Dial, Firewall, Services, DHCP Server, Nagios, Configure Dashboard, and Digital I/O. The main content area has tabs for 'Network Interface', 'Management LAN Interface', 'General Settings', and 'Route Settings'. The 'Network Interface' tab is active, showing 'IP Settings: Network' with fields for Configuration Method (Static selected), IP Address (192.168.252.202), Subnet Mask (255.255.255.0), Gateway (192.168.252.254), Primary DNS (192.168.252.254), Secondary DNS, Media (Auto), DHCP Server (Disabled), IP Alias, and Serial Port Aliases (None). Below this is the 'Failover' section with 'Failover Interface' set to 'Management LAN (lan)' and 'Dormant Failover Interface' set to 'None'. A tooltip is visible over the 'Management LAN (lan)' option, listing other disabled options: 'Serial DB9 Port (sercon) DISABLED' and 'Internal Cellular Modem (cellmodem01) DISABLED'. A note at the end of the Failover section reads 'configured and enabled for failover to work.'

- When configuring the principal network connection, specify **Management LAN Interface** as the **Failover Interface** to be used when a fault has been detected with **Network Interface**.
- Specify the **Probe Addresses** of two sites (the **Primary** and **Secondary**) that the advanced console server is to ping to determine if **Network Interface** is still operational.

5. Firewall, Failover and OOB Access

- On the **Management LAN Interface**, configure the **IP Address**, **Subnet Mask** and **Gateway** the same as you used for **Network Interface**.

System Name: b093-008-2e4u-v Model: B093-008-2E4U-V Firmware: 4.0.0u1
Uptime: 1 days, 20 hours, 42 mins, 44 secs Current User: root

Dashboard Manage Devices Backup Log Out

System: IP

Network Interface Management LAN Interface General Settings Route Settings

Disable Deactivate this network interface.

IP Settings: Management LAN - Currently Failover for Network Interface

Configuration Method DHCP Static
The mechanism to acquire IP settings.

IP Address
A statically assigned IP address.

Subnet Mask
A statically assigned network mask.

Gateway
Default gateway for the unit.

Primary DNS
A statically assigned primary name server.

In this mode, **Management LAN Interface** is available as the transparent back-up port to **Network Interface** for accessing the management network. In the event **Network Interface** becomes unavailable, **Management LAN Interface** will automatically and transparently take over the work of **Network Interface**.

Notes: Only SSH access is enabled on the failover connection. In firmware versions later than 3.0.2, HTTPS access is also enabled so the administrator can connect to the console server using SSH (or HTTPS) to fix the problem.

By default, the advanced console server supports automatic failure-recovery back to the original state prior to failover (firmware version 3.1.0 and later). The advanced console server continually pings probe addresses while in original and failover states. The original state will automatically be set as a priority and reestablished following three successful pings of the probe addresses during failover. The failover state will be removed once the original state has been re-established.

For firmware pre-V3.1.0, the advanced console server does not support automatic failure-recovery back to the original state prior to the failover. To restore networking to a recovered state, the following command needs to be run:

```
rm -f /var/run/*-failed-over && config -r ipconfig
```

If required, you can run a custom bash script when the device fails over. It is possible to use this script to implement automatic failure recovery, depending on your network setup. The script to create is:

```
/etc/config/scripts/interface-failover-alert
```

5.6 Cellular Modem Connection

The B093 and B098 family of advanced console servers support internal cellular modems. These modems first need to be installed (see section 5.6.1) and then set up to validate they can connect to the carrier network (described in 5.6.4 and 5.6.5). They then can be configured for operation in Always- on cellular router or OOB mode, or in Failover mode (detailed in next section 5.7).

5. Firewall, Failover and OOB Access

5.6.1 Connecting to a 4G LTE Carrier Network

Before powering on the console server, install the SIM card provided by your cellular carrier and attach the external aerial. Select **Internal Cellular Modem** panel on the **System: Dial** menu. Check **Enable Dial-Out Settings**.



System Name: b093-008-2e4u-v Model: B093-008-2E4U-V Firmware: 4.0.0u1
Uptime: 1 days, 20 hours, 48 mins, 14 secs Current User: root



System: Dial

Serial DB9 Port | **Internal Cellular Modem**

Carrier data charges apply while the cellular connection is active. We recommend configuring [Auto-Response Cellular Data alerts](#) and where possible monitoring data usage via your carrier's portal. Consider using Failover mode (under IP -> Network Interface -> Failover) to limit cellular activity.

Internal Cellular Modem Dial Settings

Disable Dial Disable modem communication.

Enable Dial-Out Allow outgoing modem communication.

Dial-Out Settings - Always On Out-of-Band

Control via Auto-Response Indicates that the connection will be controlled by "Network Interface" Auto-Response action. The default state for the connection will be *Down*

SIM Configuration

Primary SIM The default SIM slot to use.

Enable SIM Failover Enable failover between the Primary SIM and the Secondary on connection failure.

SIM Failover Settings

Failback Method On Disconnect On Timeout
The method used to determine when to fail-back to the Primary SIM: either when the secondary SIM loses connection, or after a fixed time period.

Note: Your 4G LTE carrier may have provided you with details for configuring the connection, including APN (Access Point Name), PIN Code (optional PIN code which may be required to unlock the SIM card), Phone Number (the sequence to dial to establish the connection, defaults to *99***1#), Username / Password (optional) and Dial string (optional AT commands). However, you generally will only need to enter your provider's APN and leave the other fields blank.

Enter the carrier's **APN**—e.g., for AT&T (USA), simply enter i2gold; for T-Mobile (USA), enter epc.tmobile.com; for InterNode (Aust), enter internode; and for Telstra (Aust), enter telstra.internet

If the SIM card is configured with a PIN code, you will be required to unlock the card by entering the PIN code. If the PIN code is entered incorrectly three times, the PUK Code will be required to unlock the card.

5. Firewall, Failover and OOB Access

You may also need to set Override DNS to use alternate DNS servers from those provided by your carrier.

- To enable Override DNS, check the **Override Returned DNS Servers** box. Enter the IP of the DNS servers into the spaces provided.

Override DNS

Override returned DNS Servers Use the following DNS Servers instead of the PPP provided servers.

DNS Server 1
The Primary DNS Server.

DNS Server 2
The Secondary DNS Server.

Dynamic DNS

Dynamic DNS None - DDNS disabled
Update a DNS server when IP address is changed.

DDNS Hostname
The Fully Qualified DNS hostname assigned to this interface.

- Check **Apply**. A radio connection will be established with your cellular carrier.

5.6.2 Verifying the Cellular Connection

Out-of-band access is enabled by default, so the cellular modem connection should now be on.

- You can verify the connection status from **Status: Statistics**
 - Select the **Cellular** tab. In Service Availability, verify Mode is set to **Online**.
 - Select **Failover & Out-of-Band**. The Connection Status should read “Connected”.
 - Check your allocated IP address.

Status: Statistics

Interfaces Routes Serial Ports IP ICMP TCP UDP **Failover & Out-of-Band** Cellular

Failover

Failover is not configured.

Always on Out-of-Band - Internal Cellular Modem (cellmodem)

Connection Status	Connected
IP Address	59.167.15.3

- You can measure the received signal strength from the Cellular Statistics page on the Status: Statistics screen. This will display the current state of the cellular modem, including the Received Signal Strength Indicator (RSSI).

Note: Received Signal Strength Indicator (RSSI) is a measurement of the Radio Frequency (RF) power present in a received radio signal at the mobile device. It is generally expressed in dBm. The best throughput comes from placing the device in an area with the highest RSSI.

-100 dbm or less = Unacceptable Coverage

-99 dbm to -90 dbm = Weak Coverage

-89 dbm to -70 dbm = Medium to High Coverage

-69 dbm or greater = Strong Coverage

5. Firewall, Failover and OOB Access

The screenshot shows the 'Status: Statistics' page in a network management interface. The left sidebar contains a tree view with categories: Serial & Network, Alerts & Logging, and System. The main content area has tabs for Interfaces, Routes, Serial Ports, IP, ICMP, TCP, UDP, Failover & Out-of-Band, and Cellular. The Cellular tab is active, displaying 'Internal Cellular Modem' details. A red circle highlights the 'Received Signal Strength Indication (RSSI in dBm)' value, which is -83.

Parameter	Value
Service Availability	Service available
Roaming Support	Supported
Current Roaming Status	Not roaming
Supported System Mode	Auto-select
Current System Mode	WCDMA mode
Network Acquisition Order	WCDMA then GSM
Radio Access Technology	UMTS 3G Preferred
Supported Service Domain	Circuit and packet-switched
Current Service Domain	Circuit and packet-switched service
SIM Status	SIM available
Received Signal Strength Indication (RSSI in dBm)	-83
Bit Error Rate	Unknown

- With the cellular modem connection on, you can also see the connection status from the LEDs on top of the unit.

5.6.3 Cellular Modem Watchdog

When you select Enable Dial-Out on the System: Dial menu, you will be given the option to configure a cellular modem watchdog service (with firmware version 3.5.2u13 and later). This service will periodically ping a configurable IP address. If a set threshold number of consecutive attempts fail, the service will cause the unit to reboot. This can be used to force a clean restart of the modem and its services to work around any carrier issues.

The screenshot shows the 'Modem Watchdog - Advanced' configuration page. It includes a description of the feature and several configuration fields: Enable watchdog (checkbox), Address (text input), Threshold (text input), Ping count (text input), and Period (text input). An 'Apply' button is at the bottom.

Modem Watchdog - Advanced

This feature configures a service which will periodically ping a configurable IP address. If a threshold number of attempts fail, the service will cause the unit to reboot. This can be used to force a clean restart of the modem and its services to work around any carrier issues.

Enable watchdog Configure a service to reboot the unit if a configurable number of ping attempts fail

Address IP address to periodically ping

Threshold Number of failed ping attempts required before rebooting

Ping count Number of pings per attempt. Defaults to 5

Period Number of seconds to wait between attempts. Defaults to 30

5. Firewall, Failover and OOB Access

5.6.4 Dual SIM Failover

Some console server models allow you to insert two SIM cards so you can selectively connect to two carrier networks. The dual SIM failover feature allows the cell modem to selectively failover to the secondary SIM when communications over the primary SIM fails.

To configure dual SIM failover, you need to:

- Choose which of the SIMs is to be the Primary, and the other SIM will be the secondary/failover. It is recommended that an explicit slot is chosen, rather than leaving it on **Automatic**. Select **Internal Cellular Modem** panel on the **System: Dial** menu nominate which slot (**Top** or **Bottom**) contains the Primary.
- Check **Enable SIM Failover**.

The screenshot shows a configuration interface for SIM settings. It is divided into two main sections: 'SIM Configuration' and 'SIM Failover Settings'.
In the 'SIM Configuration' section, there is a 'Primary SIM' dropdown menu set to 'Bottom Slot' with a note: 'The default SIM slot to use.' Below this is a checked checkbox for 'Enable SIM Failover' with the description: 'Enable failover between the Primary SIM and the Secondary on connection failure.'
The 'SIM Failover Settings' section contains two options for the 'Failback Method': 'On Disconnect' (selected) and 'On Timeout'. A note explains: 'The method used to determine when to fail-back to the Primary SIM: either when the secondary SIM loses connection, or after a fixed time period.' Below this is a 'Failback Timeout' input field with a note: 'when failed over to the secondary SIM, the primary SIM will be re-tested after this many seconds. Defaults to 600'.

- Specify how the device will **Failback** from the failover SIM to the Primary SIM. There are two options
 - o The '**On Disconnect**' failback option will failback to the Primary SIM only after the connection on the failover SIM has failed its ping test.
 - o The '**On Timeout**' failback option will failback to the Primary SIM after the connection on the failover SIM has been up for the timeout period. The timeout period is either the default value of 600 seconds if the **Failback Timeout** field is left empty or the number of seconds you have specified in the **Failback Timeout** field.
- Next, you will need to configure each SIM connection with as much information (e.g. APN, etc.), such that it will make a successful connection, assuming sufficient signal strength from the cell service provider.
- Enter a Failback Test IP address for each SIM. This IP address is used to ping test the status of the cell modem connection and to determine if SIM failover or failback is to take place.
- Configuring DDNS and the Modem Watchdog are optional. DDNS, when configured, will be applied to the cell modem dial out connection regardless of which SIM is currently in use. Dual SIM failover is for **dial out** connections only.

5.6.5 Automatic SIM Slot Detection

If a single SIM card is used in a Dual SIM slot product, the default configuration for the product is to automatically detect which slot the SIM is in and select that slot. If both slots are populated, the bottom SIM slot will be used in preference.

5. Firewall, Failover and OOB Access

5.6.6 Multi-Carrier Cellular Support

Some cellular carriers require the console server's cellular modem to be programmed with carrier-specific firmware to operate on their network. Some console server models are equipped with a reprogrammable cellular modem, allowing them to operate on more than one such carrier network.

Note: Changes to the cellular modem firmware are unaffected by Tripp Lite firmware upgrades or factory erase/configuration reset operations.

To switch carriers using the UI:

- For devices with multi-carrier capability, the **System: Dial: Internal Cellular Modem** tab provides control over which carrier's firmware is installed on the modem.
- Select the desired carrier and click the Change Carrier button to program the modem's flash with the carrier-specific firmware image(s).

Serial DB9 Port Internal Cellular Modem

Carrier data charges apply while the cellular connection is active. We recommend configuring [Auto-Response Cellular Data alerts](#) and where possible monitoring data usage via your carrier's portal. Consider using Failover mode (under [IP -> Network Interface -> Failover](#)) to limit cellular activity.

Internal Cellular Modem Dial Settings

Disable Dial Disable modem communication.

Enable Dial-Out Allow outgoing modem communication.

Apply Modem Dial Settings

Internal Cellular Modem Carrier Settings

This feature allows the modem to switch to a different carrier. Dial-Out must be disabled, and as part of this procedure, the SIM configuration will be reset. The process can take several minutes, and the modem will be unresponsive during this time.

Carrier AT&T
 Verizon
 Telus
 Rogers

Switch to a different cellular carrier.

Change Carrier

- The flashing process takes several minutes during which the cellular modem is unavailable. During this time, the page periodically refreshes with status information. Upon successful completion, the page displays the message: **Cellular Firmware carrier change completed.**

Multi-carrier capable models ship with cellular modem firmware for each supported carrier pre-loaded onto internal non-volatile or USB storage. Periodically, new cellular modem firmware becomes available and is published on the Tripp Lite downloads site.

Note: If your unit's cellular connection is operating correctly, there is typically no need to upgrade its cellular firmware.

To download and apply new cellular firmware using the UI:

- For devices with multi-carrier capability, the **System: Firmware** page shows a second section with local cellular firmware image status and a button to start the firmware update process.
- The **Cellular Firmware Status** indicates the date of the last firmware download, and a cryptographic fingerprint that can be used to verify the local files' integrity through Tripp Lite Technical Support..
- Click the **Check for Update** button to step through the upgrade process. This process contacts the remote server and displays an update summary.

5. Firewall, Failover and OOB Access

- The update summary indicates the local and remote fingerprints for comparison, without altering any of the local files. The **Advanced** section, when expanded, shows a full list of files to be downloaded or deleted, along with their SHA1 hashes (temporary files downloaded during the initial **Check for Updates** check may be listed as simple files to “copy” into place, as they do not have to be re-downloaded).

Message Cellular Firmware update check completed.

Cellular Modem Firmware

Modem Firmware Status Updated firmware available.

Local repository fingerprint: **8f688d31eafd321a9bac7bad9fbc3debad1704eb**
 Updated repository fingerprint: **c46ad92e65e59bc683df7aae96582a422ed0ee3a**

Before upgrading, ensure the updated fingerprint matches that of the remote repository. Repository fingerprints are published on the Knowledge Base site. Downloading firmware may use a significant amount of data (>100MB).

Advanced

Local storage repository will be synced from the remote repository:

Action	SHA1 Checksum	Filename
download	d486dcf44e7925396e19ba3eb3b426e9bea862cc	carrier-canon.txt
download	d8e6ccad26645ab10b571fa64889bb393a2c8968	carriers.txt
keep	ca599c42c5d50ebd218da09d030c1db63ad7664a	SWI9X15C_05.05.58.00.cwe
keep	b0b80c876dfe5dc0836093fe0c3fce4c357bb9b	SWI9X15C_05.05.58.00_ATT_005.026_000.nvu
keep	d319aa331491363dede70506f792578173a80e07	SWI9X15C_05.05.58.00_Rogers_005.022_000.nvu
keep	f7ce1b5543fea5ca271fd0c2ad0b4b17c7e0eec2	SWI9X15C_05.05.58.00_Telus_005.023_000.nvu
keep	5c69d24e6380719aa0de3b5c581c199e52641220	SWI9X15C_05.05.58.01.cwe
keep	f1baa57e65b70ff542329da73b3c674bf8490cad	SWI9X15C_05.05.58.01_Verizon_005.029_000.nvu
copy	41dc81f6781a02211816ca63a5d149148ab01ec8	cell-firmware.txt
copy	-	localfiles.txt
copy	-	localdb.txt
copy	-	SHA1SUMS

Download and Upgrade

Cancel

- Click **Download and Apply** to start the update. All files suitable for the modem are downloaded, but the modem will only be flashed if new firmware is available for the currently selected carrier. Alternatively, click **Cancel** to reject the update.
- During the download/apply, an interstitial screen is displayed showing **Currently upgrading cellular modem firmware**. Once completed, the status of the firmware update is displayed by the **System: Firmware** page.
- This operation may be automated by enabling the Automatic Cellular Modem Firmware Check and Upgrade option. This allows the user to schedule these checks on a daily, weekly, or monthly schedule, and specify the time of day that the check will run. If new firmware is found, the device will automatically download and apply it.

Cellular Modem Firmware

When updated firmware becomes available in the remote repository, it may be downloaded to this unit's local storage and applied to its cellular modem.

Modem Firmware Status Local repository fingerprint: c46ad92e65e59bc683df7aae96582a422ed0ee3a
 Local repository last updated: 2017-11-16

Check for Update

Automated Cellular Modem Firmware Check and Upgrade

Check Enabled

Check Frequency Weekly
 The Weekly and Monthly checks will occur on the first day of the week (Sunday) and the first day of the month.

Check Time 8 PM

Apply Automated Check and Upgrade

5. Firewall, Failover and OOB Access

Advanced users may also control multi-carrier features from the CLI:

- Show currently selected carrier:
`cellctl -is | egrep " ^ preferred-carrier" | cut -d " " -f 2`
- Show current modem firmware version:
`cellctl -is | egrep " ^ current-firmware" | cut -d " " -f 2`
- List available carriers supported on installed modem:
`/etc/scripts/cell-fw-update -l`
- Check for availability of firmware updates:
`/etc/scripts/cell-fw-update -u`

Output is the remote fingerprint followed by the list of actions that would be taken by `cell-fw-update -d`.

- Download latest firmware for all carriers supported by the modem:
`/etc/scripts/cell-fw-update -d`
Also specify `-v` to show verbose download progress.
- Flash modem with latest local firmware for carrier:
`/etc/scripts/cell-fw-update -c <carrier>`

where `<carrier>` is one of the carrier identifiers emitted by `cell-fw-update -l`. This command can be used to switch carriers or to update the firmware of the current carrier. If the firmware version information on the modem is identical, the modem may reject the update without error.

5.7 Cellular Operation

The cellular modem can be set up to connect to the carrier in:

- **Cellular router mode.** In this mode, the dial-out connection to the carrier cellular network is always on, and IP traffic is routed between the cellular connected network and the console server's local network ports. This is the default mode of operation.
- **OOB mode.** In this mode, the dial-out connection to the carrier's cellular network is always on and awaiting incoming access from a remote site to the console server or attached serial consoles/network hosts.
- **Failover mode.** In this mode, a dial-out cellular connection is established only in the event of a ping failure.
- **Circuit Switched Data (CSD) mode.** In this dial-in mode the cellular modem can receive incoming calls from remote modems who dial a special Data Terminating number. This is a 3G mode only.

5.7.1 Set Up OOB Access

In this mode, the dial-out connection to the carrier cellular network is always on and awaiting any incoming traffic. By default, the only traffic enabled is incoming SSH access to the console server, its serial ports, and incoming HTTPS access to the console server. There is a low level of management traffic going over the cellular network. Generally, the status reports and alerts from the site can be carried over the main network.

This mode is typically used for out-of-band (OOB) access to remote sites. To directly access the Tripp Lite console server, a public IP address is needed and must not have SSH access firewalled. This OOB mode is the default for Tripp Lite console servers with internal cellular modems. OOB access is enabled by default and the cellular modem connection is always on.

For direct access, the console server needs to have a public IP address and must not have SSH access firewalled.

Almost all carriers offer corporate mobile data service/plans with a public (static or dynamic) IP address. These plans often have a service fee attached.

- If you have a static public IP address plan, you can also try accessing the console server using the public IP address provided by the carrier. By default, only HTTPS and SSH access is enabled on the OOB connection so you can browse to the console server, but you cannot ping it.
- If you have a dynamic public IP address plan, a DDNS service will need to be configured to enable the remote administrator to initiate incoming access. Once this is done, you can also try accessing the console server using the allocated domain name.

5. Firewall, Failover and OOB Access

By default, most providers offer a consumer grade service, which provides dynamic private IP address assignments to 3G devices. This IP address is not visible across the Internet, but generally, it is adequate for home and general business use.

- With such a plan, the **Failover & Out-of-Band** tab on the **Status: Statistics** will identify that your carrier has allocated you a private IP address (i.e. in the range 10.0.0.0 – 10.255.255.255, 172.16.0.0 – 172.31.255.255 or 192.168.0.0 – 192.168.255.255).

The screenshot shows the 'Status: Statistics' page with the 'Failover & Out-of-Band' tab selected. The 'Failover' section indicates it is not configured. The 'Always on Out-of-Band - Internal Cellular Modem (cellmodem)' section shows a 'Connected' status and an IP address of 10.168.76.104, with a warning that this is a private IP address requiring VPN for incoming connections.

- For inbound OOB connection, you will need to set up a VPN.

In out-of-band access mode, the internal cellular modem will continually stay connected. The alternative is to set up failover mode on the console server (detailed in the next section).

5.7.2 Set Up Cellular Failover

In this mode, a dial-out cellular connection is only established in the event of a disruption to the main network. The cellular connection normally remains idle in a low power state and is only activated in the event of a ping failure. Standby mode is ideal for remote sites with expensive power or very high cellular traffic costs.

In this mode, the console server continually pings select probe addresses over the main network connection. During a ping failure, it dials out and sets up a dial-out ppp over the cellular modem and access is switched transparently to this network connection. When the main network connection is restored, access is switched back.

Once you have configured the carrier connection, the cellular modem can be configured for failover.

This will tell the cellular connection to remain idle in a low power state. If the primary and secondary probe addresses are not available, it will reestablish the cellular connection and reconnect to the cellular carrier.

The screenshot shows the 'Failover Interface' configuration page. A dropdown menu is open, showing options: 'None', 'Serial Console/Port 1 (sercon) DISABLED', and 'Internal Cellular Modem (cellmodem01)'. The 'Internal Cellular Modem (cellmodem01)' option is selected. Below the dropdown are fields for 'Primary Probe Address' and 'Secondary Probe Address', both with descriptive text: 'The address of the first peer to probe for connectivity detection.' and 'The address of the second peer to probe for connectivity detection.' respectively.

- Navigate to the **Network Interface** on the **System: IP** menu and specify **Internal Cellular modem (cell modem 01)** as the **Failover Interface** to be used when a fault has been detected.
- Specify the **Probe Addresses** of two sites (the **Primary** and **Secondary**) that the console server is to ping to determine if the principal network is still operational.
- In event of a failure of the principal network, the cellular network connection is activated as the access path to the console server (and Managed Devices). Only HTTPS and SSH access is enabled on the failover connection (which should enable the administrator to connect and fix the problem).

5. Firewall, Failover and OOB Access

Note: By default, the advanced console server supports automatic failure-recovery back to the original state prior to failover (firmware version 3.1.0 and later). The advanced console server continually pings probe addresses while in original and failover states. The original state will automatically be set as a priority and reestablished following three successful pings of the probe addresses during failover. The failover state will be removed once the original state has been re-established.

For earlier firmware that does not support automatic failure-recovery, restore networking to a recovered state by running the following command:

```
rm -f /var/run/*-failed-over && config -r ipconfig
```

If required, you can run a custom bash script when the device fails over. It is possible to use this script to implement automatic failure recovery, depending on your network setup. The script to create is:

```
/etc/config/scripts/interface-failover-alert
```

- You can check the connection status by selecting the **Cellular** panel on the **Status: Statistics** menu.

Interfaces	Routes	Serial Ports	IP	ICMP	TCP	UDP	Failover & Out-of-Band
Failover							
Main Connection				Network (wan)			
Failover Connection				Management LAN (lan)			
Active Connection				Main			
Connection Status				Connected			
IP Address				192.168.250.106			
<i>Warning: This is a private IP address, VPN is required to enable incoming connections.</i>							
Out-of-Band/Failover (oobfo)							
Connection Status				Establishing connection			
IP Address				0.0.0.0			

- o The operational status will change as the cellular modem finds a channel and connects to the network.
- o The **Failover & Out-of-Band** screen will display information relating to a configured Failover/OOB interface and the status of that connection. The IP address of the Failover / OOB interface will be presented in the **Failover & Out-of-Band** screen once the Failover/OOB interface has been triggered.

5.7.3 Cellular Routing

Once you have configured the carrier connection, the cellular modem can be configured to route traffic through the console server. This requires setting up forwarding and masquerading (refer to **5.8 Firewall and Forwarding**).

5. Firewall, Failover and OOB Access

5.7.4 Set Up Cellular CSD Dial-In

Once you have configured the carrier connection, the cellular modem can be configured to receive Circuit Switched Data (CSD) calls.

Note: CSD is a legacy form of data transmission developed for the TDMA-based mobile phone systems like GSM. CSD uses a single radio time slot to deliver 9.6kb/s data transmission to the GSM Network and Switching Subsystem, where it could be connected through the equivalent of a normal modem to the Public Switched Telephone Network (PSTN) and allow direct calls to any dial-up service. CSD is provided selectively by carriers. As such, it is important you receive a Data Terminating number as part of the mobile service your carrier provides. This is the number that external modems will call to access the console server.

- Select the **Cellular Modem** panel on the **System: Dial** menu.
- Check **Enable Dial-In** and configure the **Dial-In Settings**.

System: Dial

Serial Console/Port 1	Internal Cellular Modem
Internal Cellular Modem Dial Settings	
Disable Dial	<input type="radio"/> Disable modem communication.
Enable Dial-In	<input checked="" type="radio"/> Allow incoming modem communication.
Enable Dial-Out	<input type="radio"/> Allow outgoing modem communication.
Dial-In Settings	
Username	<input type="text"/> The username for authentication.
Password	<input type="text"/> The secret to use when authenticating the user.
Confirm	<input type="text"/> Re-enter the user's password for confirmation.
Remote Address	<input type="text"/> The IP address to assign a dial-in client.
Local Address	<input type="text"/> The IP address for the dial-in server.
Default Route	<input type="checkbox"/> The dialed connection is to become a default route for the system.
Custom Modem Initialization	<input type="text"/> An optional AT command sequence to initialize the modem.
Authentication Type	<input type="radio"/> None <input type="radio"/> PAP <input type="radio"/> CHAP <input type="radio"/> MSCHAPv2 The method to use when checking the dial-in users credentials.
Calling Number Filtering	<input type="checkbox"/> Allow dial in from phone numbers matching the permitted calling number only.
Permitted Calling Number	<input type="text"/> A complete phone number or regular expression to match against the calling number.
Dynamic DNS	
Dynamic DNS	<input type="text" value="None - DDNS disabled"/> Update a DNS server when IP address is changed.
DDNS server	<input type="text"/> The DDNS server to push updates to.

5. Firewall, Failover and OOB Access

5.8 Firewall and Forwarding

Tripp Lite console servers with version 3.3 firmware (and later) have basic routing, NAT (Network Address Translation), packet filtering and port forwarding support on all network interfaces. This enables the console server to function as an Internet or external network gateway, via cellular connections or other Ethernet networks on two Ethernet port models:

- **Network Forwarding** allows the network packets on one network interface (i.e. LAN1 / eth0) to be forwarded to another network interface (i.e. LAN2/eth1 or dial-out/cellular). Locally networked devices can IP connect through the console server to devices on remote networks.
- **IP Masquerading** is used to allow all devices on your local private network to hide behind and share one public IP address when connecting to a public network. This type of translation is only used for connections originating within the private network destined for the outside public network. Each outbound connection is maintained using a different source IP port number.

When using IP masquerading, devices on the external network cannot initiate connections to devices on the internal network. **Port Forwards** allow external users to connect to a specific port on the external interface of the console server and be redirected to a specified internal address for a device on the internal network.

- With **Firewall Rules**, packet filtering inspects each packet passing through the firewall and accepts or rejects it based on user-defined rules.
- Then **Service Access Rules** can be set for connecting to the console server/router itself.

5.8.1 Configuring Network Forwarding and IP Masquerading

To use a console server as an Internet or external network gateway requires establishing an external network connection, then enabling forwarding and masquerading functions.

Note: Network forwarding allows the network packets on one network interface (i.e. LAN1 / eth0) to be forwarded to another network interface (i.e. LAN2/eth1 or dial-out/cellular) so locally networked devices can IP connect through the console server to devices on a remote network. IP masquerading is used to allow all the devices on your local private network to hide behind and share one public IP address when connecting to a public network. This type of translation is only used for connections originating within the private network destined for the outside public network, and each outbound connection is maintained by using a different source IP port number.

By default, all console server models are configured so they will not route traffic between networks. To use the console server as an Internet or external network gateway, forwarding must be enabled so traffic can be routed from the internal network to the Internet/external network.

5. Firewall, Failover and OOB Access

- Navigate to the **System: Firewall** page, then click on the **Forwarding & Masquerading** tab.

The screenshot shows the TRIPP-LITE web interface for the 'System: Firewall' configuration. The top navigation bar includes the TRIPP-LITE logo, system information (System Name: b093-008-2e4u-v, Model: B093-008-2E4U-V, Firmware: 4.0.0u1, Uptime: 1 days, 21 hours, 25 mins, 41 secs, Current User: root), and utility icons for Dashboard, Manage Devices, Backup, and Log Out. The main content area is titled 'System: Firewall' and has three tabs: 'Port/Protocol Forwarding', 'Firewall Rules', and 'Forwarding & Masquerading'. The 'Forwarding & Masquerading' tab is active, showing a table for 'Network Forwarding and Masquerading'. The table has two columns: 'Source Networks' and 'Allowed Destination Networks'. The rows are: 'Network Interface', 'Management LAN', 'Dialout/Cellular', 'Dial-in', and 'VPN'. In the 'Management LAN' row, the 'Dialout/Cellular' checkbox is checked. A left sidebar contains a 'System' menu with options like Administration, SSL Certificates, Configuration Backup, Firmware, IP, Date & Time, Dial, Firewall, Services, DHCP Server, Nagios, and Configure Dashboard. Below the table is a section for 'Enable IP Masquerading (SNAT)' with checkboxes for the same network types and a descriptive text: 'IP Masquerading is used to translate private network traffic onto public networks such as the Internet. This is generally required when using the interface as an Internet gateway.'

- Find the **Source Network** to be routed, then select the relevant **Destination Network** to enable Forwarding.

For example, to configure a single Ethernet device as a cellular router:

- The **Source Network** would be the **Network Interface** and the **Destination Network** would be **Dial-Out/Cellular**.

IP masquerading is generally required if the console server will be routed to the Internet or if the external network it is being routed to does not have routing information about the internal network behind the console server.

IP masquerading performs Source Network Address Translation (SNAT) on outgoing packets to make them appear as if they are from the console server (rather than devices on the internal network). When response packets come back to devices on the external network, the console server will translate the packet address back to the internal IP so that it is routed correctly. This allows the console server to provide full outgoing connectivity for internal devices using a single IP address on the external network.

By default, IP masquerading is disabled for all networks. To enable masquerading:

- Select **Forwarding & Masquerading** panel on the **System: Firewall** menu.
- Check **Enable IP Masquerading (SNAT)** on the network interfaces where masquerading is to be enabled.

Masquerading is typically applied to any interface that is connecting with a public network such as the Internet.

This section shows the 'Enable IP Masquerading (SNAT)' configuration. It features a title 'Enable IP Masquerading (SNAT)' and a list of checkboxes for 'Network Interface', 'Management LAN', 'Dialout/Cellular', 'Dial-in', and 'VPN'. Below the checkboxes is a text box containing the explanation: 'IP Masquerading is used to translate private network traffic onto public networks such as the Internet. This is generally required when using the interface as an Internet gateway.'

5. Firewall, Failover and OOB Access

5.8.2 Configuring Client Devices

Client devices on the local network must be configured with Gateway and DNS settings. This can be done statically on each device or using DHCP.

Manual Configuration

Manually set a static gateway address (the address of the console server) and set the DNS server address to be the same as used on the external network. If the console server is acting as an internet gateway or a cellular router, use the ISP provided DNS server address.

DHCP Configuration

- Navigate to the **System: IP** page.
- Click the tab of the interface connected to the internal network. To use DHCP, a static address must be set. Check that the static IP and subnet mask fields are set.



System Name: b093-008-2e4u-v Model: B093-008-2E4U-V Firmware: 4.0.0u1
Uptime: 1 days, 21 hours, 27 mins, 48 secs Current User: root



System: IP

Manage | Status | Serial & Network | Alerts & Logging | System

Network Interface | Management LAN Interface | General Settings | Route Settings

IP Settings: Network

Configuration Method DHCP Static
The mechanism to acquire IP settings.

IP Address 192.168.254.36
A statically assigned IP address.

Subnet Mask 255.255.255.0
A statically assigned network mask.

Gateway 192.168.254.254
Default gateway for the unit.

Primary DNS
A statically assigned primary name server.

Secondary DNS
A statically assigned secondary name server.

Media Auto
The Ethernet media type.

DHCP Server Disabled
Configure a DHCP server for this interface.

IP Alias
Secondary address or comma-separated list of addresses in CIDR notation, e.g. 192.168.1.1/24.

Serial Port Aliases None

5. Firewall, Failover and OOB Access

- Click on the **Disabled** link next to **DHCP Server**, which will open the **System: DHCP Server** page.

System Name: b093-008-2e4u-v Model: B093-008-2E4U-V Firmware: 4.0.0u1
Uptime: 1 days, 21 hours, 30 mins, 6 secs Current User: root

Dashboard Manage Devices Backup Log Out

System: DHCP Server

Manage

Status

- Port Access
- Active Users
- Statistics
- Support Report
- Syslog
- UPS Status
- RPC Status
- LLDP/CDP Neighbors
- Environmental Status
- Dashboard

Serial & Network

Alerts & Logging

System

- Administration
- SSL Certificates
- Configuration Backup
- Firmware
- IP
- Date & Time
- Dial
- Firewall
- Services
- DHCP Server
- Nagios
- Configure Dashboard
- Digital I/O

Network Interface Management LAN Interface

Network DHCP Server Settings (Subnet 10.5.0.0 / 255.255.255.0)

DHCP Server Enable DHCP Server

Gateway
The Default Gateway to assign.

Use interface address as gateway Use this interface as the DHCP Gateway.

Primary DNS
The primary DNS to assign.

Secondary DNS
The secondary DNS to assign.

Use this interface address as the DNS server Use the built-in DNS relay for DNS lookups.
The DNS service must be enabled on the [Services page](#)

Domain Name
The Domain Name to assign.

Default Lease
The Default Lease Time in Seconds.

Maximum Lease
The Maximum Lease Time in Seconds.

Apply

- Check **Enable DHCP Server**.
- To configure the DHCP server, select the **Use interface address as gateway** check box.
- Set the DNS server address(es) to be the same as used on the external network. If the console server is acting as an internet gateway or a cellular router, then use the ISP provided DNS server address
- Enter the **Default Lease** time and **Maximum Lease** time in seconds. The lease time is the time that a dynamically assigned IP address is valid before the client must request it again.
- Click **Apply**.

The DHCP server will sequentially issue IP addresses from a specified address pool(s):

- Click **Add** in the **Dynamic Address Allocation Pools** field.
- Enter the **DHCP Pool Start Address** and **End Address**. Click **Apply**.

System Name: b093-008-2e4u-v Model: B093-008-2E4U-V Firmware: 4.0.0u1
Uptime: 1 days, 21 hours, 31 mins, 43 secs Current User: root

Dashboard Manage Devices Backup Log Out

System: DHCP Server

Manage

Status

- Port Access
- Active Users
- Statistics
- Support Report
- Syslog
- UPS Status
- RPC Status
- LLDP/CDP Neighbors
- Environmental Status
- Dashboard

Network Interface Management LAN Interface

Dynamically Allocated Pool

DHCP Pool Start Address
The first address in the pool to use for DHCP.

DHCP Pool End Address
The last address in the pool to use for DHCP.

Apply

5. Firewall, Failover and OOB Access

The DHCP server also supports pre-assigning IP addresses to be allocated only to specific MAC addresses and reserving IP addresses to be used by connected hosts with fixed IP addresses.

Once applied, devices on the internal network will be able to access resources on the external network.

5.8.3 Port / Protocol Forwarding

When using IP masquerading, devices on the external network cannot initiate connections to devices on the internal network.

To work around this, port forwarding can be set up to allow external users to connect to a specific port or range of ports on the external interface of the console server/cellular router. The console server/cellular router redirects the data to a specified internal address and port range.

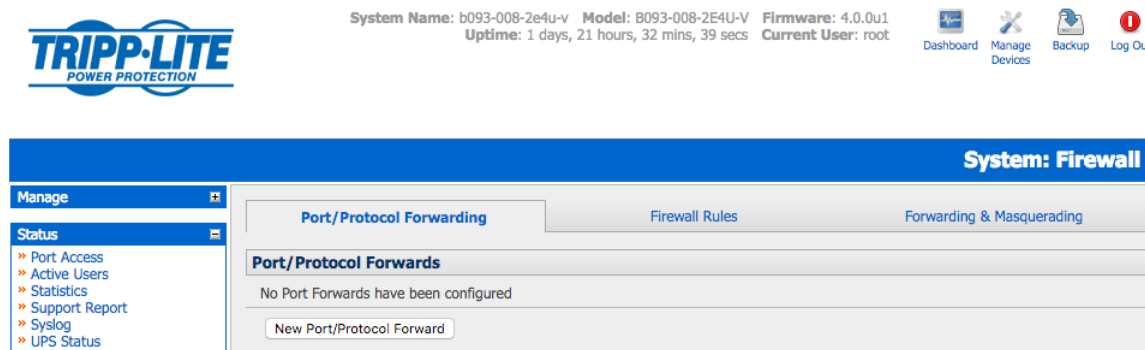

To set up a port/protocol forward:

- Navigate to the **System: Firewall** page and click on the **Port Forwarding** tab.
- Click **Add New Port Forward**.
- Fill in the following fields:

- Name:** Name for the port forward. This should describe the target and the service that the port forward is used to access.
- Input Interface:** This allows the user to only forward the port from a specific interface. In most cases, this should be left as "Any".
- Source Address/Address Range:** This allows the user to restrict access to a port forward to a specific source IP address or IP address range of the data. This may be left blank. IP address ranges use the format ip/netmask (where netmask is in bits 1-32).
- Destination Address/Address Range:** The destination IP address/address range to match. This may be left blank. IP address ranges use the format ip/netmask (where netmask is in bits 1-32).
- Input Port Range:** The range of ports to forward to the destination IP. These will be the port(s) specified when accessing the port forward. These ports do not need to be the same as the output port range.
- Protocol:** The protocol of the data being forwarded. The options are **TCP or UDP, TCP and UDP, ICMP, ESP, GRE** and **Any**.
- Output Address:** The target of the port forward. This is an address on the internal network where packets sent to the Input Interface on the input port range are sent.
- Output Port Range:** The port or range of ports that the packets will be redirected to on the Output Address. Ranges use the format start-finish. This option is only valid for TCP and UDP protocols.

5. Firewall, Failover and OOB Access



System Name: b093-008-2e4u-v Model: B093-008-2E4U-V Firmware: 4.0.0u1
Uptime: 1 days, 21 hours, 33 mins, 39 secs Current User: root

Dashboard Manage Devices Backup Log Out

System: Firewall

- Manage
- Status
 - » Port Access
 - » Active Users
 - » Statistics
 - » Support Report
 - » Syslog
 - » UPS Status
 - » RPC Status
 - » LLDP/CDP Neighbors
 - » Environmental Status
 - » Dashboard
- Serial & Network
- Alerts & Logging
- System
 - » Administration
 - » SSL Certificates
 - » Configuration Backup
 - » Firmware
 - » IP
 - » Date & Time
 - » Dial
 - » Firewall
 - » Services
 - » DHCP Server
 - » Nagios
 - » Configure Dashboard
 - » Digital I/O

Port/Protocol Forwarding

Firewall Rules

Forwarding & Masquerading

Create/Modify Port/Protocol Forward

Name	<input type="text" value="New Forward Rule"/> <small>Name for the rule</small>
Interface	<input type="text" value="Any"/> <small>The interface that the rule applies to</small>
Source Address/Address Range	<input type="text"/> <small>The source IP address or IP address range of the data. This may be left blank IP address ranges use the format ip/netmask (where netmask is in bits 1-32)</small>
Destination Address/Address Range	<input type="text"/> <small>The destination IP address/address range to match. This may be left blank IP address ranges use the format ip/netmask (where netmask is in bits 1-32)</small>
Input Port Range	<input type="text"/> <small>A port or range of ports. Ranges use the format start-finish. Only valid for TCP and UDP protocols</small>
Protocol	<input type="text" value="TCP"/> <small>The protocol of the data</small>
Output Address	<input type="text"/> <small>The IP address that the data should be redirected to</small>
Output Port Range	<input type="text"/> <small>A port or range of ports. Ranges use the format start-finish. Only valid for TCP and UDP protocols</small>

For example, to forward port 8443 to an internal HTTPS server on 192.168.10.2, the following settings are used:

- Input Interface: Any
- Input Port Range: 8443
- Protocol: TCP
- Output Address: 192.168.10.2
- Output Port Range: 443

97

5. Firewall, Failover and OOB Access

5.8.4 Firewall Rules

Firewall rules can be used to block or allow traffic through an interface based on port number, the source and/or destination IP address (range), the direction (ingress or egress) and the protocol. This can be used to allow custom on-box services, or block traffic based on policy.

To set up a firewall rule:

- Navigate to the **System: Firewall** page and click on the **Firewall Rules** tab.

The screenshot shows the Tripp-Lite web interface. At the top, the system name is b093-008-2e4u-v, model is B093-008-2E4U-V, and firmware is 4.0.0u1. The uptime is 1 day, 21 hours, 35 mins, 22 secs, and the current user is root. There are navigation icons for Dashboard, Manage Devices, Backup, and Log Out. The main content area is titled 'System: Firewall' and has three tabs: 'Port/Protocol Forwarding', 'Firewall Rules' (selected), and 'Forwarding & Masquerading'. Under the 'Firewall Rules' tab, there is a section for 'Create/Modify Firewall Rule - IPv4'. The form contains the following fields:

- Name:** New Firewall Rule (Name for the rule)
- Interface:** Any (The interface that the rule applies to)
- Destination Port/Port Range:** (A port or range of ports. Ranges use the format start-finish. Only valid for TCP and UDP protocols)
- Source MAC address:** (The source MAC address to match. This may be left blank. MAC addresses use the following format XX:XX:XX:XX:XX:XX (where XX are hex digits))
- Source Address/Address Range:** (The source IP address/address range to match. This may be left blank. IP address ranges use the format ip/netmask (where netmask is in bits 1-32))
- Destination Address/Address Range:** (The destination IP address/address range to match. This may be left blank. IP address ranges use the format ip/netmask (where netmask is in bits 1-32))
- Protocol:** TCP (The protocol of the data)
- Direction:** Ingress (The direction of the data that the rule applies to)
- Connection State:** Any (Connection tracking state for the packet)
- Action:** Block (The action to undertake)

A 'Save' button is located at the bottom of the form.

Note: Prior to firmware version 3.4, this tab was labeled Port Rules and fewer firewall rules could be configured.

- Click **New Firewall Rule**.
- Fill in the following fields:

- Name** Name the rule. This name should describe the firewall rule policy being implemented (e.g., **block ftp, Allow Tony**).
- Interface** Select the interface the firewall rule will be applied to (i.e. **Any, Dial-Out/Cellular, VPN, Network Interface, Dial-in** etc).
- Port Range** Specify the Port or range of Ports (e.g. 1000 – 1500) the rule will apply to. This may be left blank.
- Source MAC Address** Specify the source MAC address to be matched. This may be left blank. MAC addresses use the format XX:XX:XX:XX:XX:XX, where XX are hex digits.
- Source Address Range** Specify the source IP address (or address range) to match. IP address ranges use the format ip/netmask (where netmask is in bits 1-32). This may be left blank.
- Destination Range** Specify the destination IP address/range to match. IP address ranges use the format ip/netmask (where netmask is in bits 1-32). This may be left blank.

5. Firewall, Failover and OOB Access

Protocol	Select if the firewall rule will apply to TCP or UDP, TCP and UDP, ICMP, ESP, GRE or Any .
Direction	Select the traffic direction the firewall rule will apply to (Ingress = incoming, or Egress).
Action	Select the action (Accept or Block) that will be applied to the detected packets that match the Interface + Port Range + Source/Destination Address Range + Protocol + Direction.

For example, to block all SSH traffic from leaving Dial-Out Interface, the following settings can be used:

Interface: Dial-Out/Cellular

Port Range: 22

Protocol: TCP

Direction: Egress

Action: Block

Firewall rules are processed in a set order- from top to bottom. As such, rule placement is important. For example, with the following rules, all incoming traffic over the Network Interface is blocked, except when it comes from two assigned IP addresses (SysAdmin and Tony):

	To allow all incoming traffic on all interfaces from the SysAdmin:	To allow all incoming traffic from Tony:	To block all incoming traffic from the Network Interface:
Interface	Any	Any	Network Interface
Port Range	Any	Any	Any
Source MAC	Any	Any	Any
Source IP	IP address of SysAdmin	IP address of Tony	Any
Destination IP	Any	Any	Any
Protocol	TCP	TCP	TCP
Direction	Ingress	Ingress	Ingress
Action	Accept	Accept	Block

System: Firewall										
Service Access			Port Forwarding			Firewall Rules			Forwarding & Masquerading	
Firewall Rules										
Name	Interface	Protocol	Destination Port/Port Range	Source Address/Address Range	Destination Address/Address Range	Direction	Action	Rule Order	Modify	Delete
Allow Sys Admin	any	tcp	Any	192.168.0.0/16	Any	ingress	accept	↓	📄	🗑️
Allow Tony	any	tcp	Any	10.0.0.0/8	Any	ingress	accept	↕	📄	🗑️
Block Everyone Else	wan	tcp	Any	Any	Any	ingress	block	↑	📄	🗑️

[New Firewall Rule](#)

However, if the above **Rule Order** changed so the “Block Everyone Else” rule was second on the list, then the incoming traffic over the network interface from Tony would be blocked.

5. Firewall, Failover and OOB Access

5.8.5 Packet State Matching in Firewall Rules

As of firmware version 4.0.0, firewall rules can include packet state matching. This is implemented using an **iptables** extension module and can be set as follows:

Navigate to **System > Firewall > Firewall Rules**.

In either the IPv4 or IPv6 section, click the **New Firewall Rule** button.

Enter a **Name** for the new rule in the Name field.

Select the interface the new rule will be applied against from the **Interface** pop-up menu.

Note: the available interfaces vary depending on the exact hardware available on the console server. By default, new firewall rules are applied against Any (i.e. all) available interface.

If the selected interface operates the TCP or UDP protocol, enter a port or port range of the rule's destination.

If the firewall rule is to apply against a particular MAC address, enter this value in the **Source MAC** address field. MAC addresses must be entered in standard xx:xx:xx:xx:xx:xx format (where each xx is a hexadecimal value).

If the firewall rule is to apply against a particular source address or range of source addresses, enter this address or address range in the **Source Address/Address Range** field. Address ranges can be entered using the ip-address/netmask syntax.

If the firewall rule is to apply to a particular destination address or address range, enter this address or address range in the **Destination Address/Address Range** field. As with the Source Address/Address Range field, address ranges can be entered using the ip-address/netmask syntax.

Set the data protocol against which firewall rule will apply. By default, new firewall rules apply against the TCP protocol.

Set the direction of data travel against which firewall rule will apply. This setting can take one of two values: Ingress or Egress. The default is Ingress. Ingress means data arriving at an interface from elsewhere. Egress means data leaving an interface and going to elsewhere.

Select the desired packet state to match against from the **Connection State** pop-up menu. Available options are New, Established/Related and Any. The default option is Any.

Note: The default option leaves packet state matching inactive. With this option, no extra specifications are added to the firewall rule.

Select the desired action to be taken regarding packets of the chosen state from the Action pop-up menu. The two available options are Block and Accept. The default action is Block.

Click the Save button. Using the **Connection State** pop-up menu in **System > Firewall > Firewall Rules > IPv4 > New Firewall Rule** to set packet state matching to New or Established/Related is equivalent to running one of the following at a shell-prompt:

```
# iptables -m state --state NEW
# iptables -m state --state \
ESTABLISHED,RELATED
```

For example:

```
# iptables -I INPUT -p tcp --dport 23 -m state --state \
ESTABLISHED,RELATED -j ACCEPT
```

This tells the firewall to accept incoming Telnet traffic for previously established Telnet sessions.

If the rule is created in **IPv6 > New Firewall Rule**, it is the equivalent of running one of the following at a shell-prompt:

```
# ip6tables -m state --state NEW
# ip6tables -m state --state ESTABLISHED,RELATED
```

For example:

```
# ip6tables -I INPUT -p tcp --dport 23 -m state --state \
ESTABLISHED,RELATED -j ACCEPT
```

As with the iptables example, this tells the firewall to accept incoming telnet traffic for previously established telnet sessions.

For more on iptables, ip6tables and iptables-extensions, see the respective man pages: iptables, ip6tables and iptables-extensions.

6. SSH Tunnels and SDT Connector

Each console server has an embedded SSH server and uses SSH tunneling so remote users can securely connect through the console server to managed devices by using text-based console tools (e.g., SSH, telnet, SoL), or graphical tools (e.g., VNC, RDP, HTTPS, HTTP, X11, VMware, DRAC, iLO).

The managed devices being accessed can be located on the same local network as the console server, or they can be attached to the console server via serial port. The remote User/Administrator connects to the console server by way of SSH tunnel using a dial-up, wireless or ISDN modem, broadband Internet connection, enterprise VPN or local network connection.

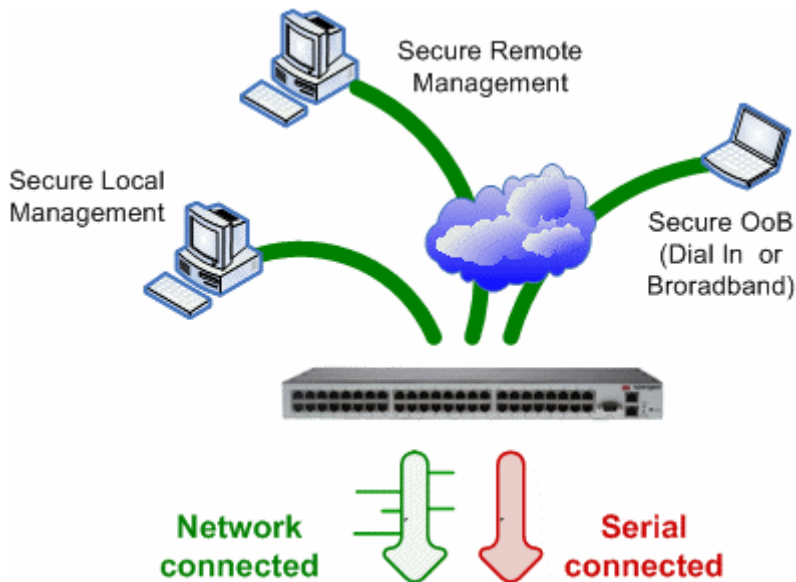

To set up the secure SSH tunnel from the client PC to the console server, you must install and launch SSH client software on the User/Administrator PC. Tripp Lite recommends you use the SDT Connector client software supplied with the console server for this task. SDT Connector is simple to install and auto-configure and will provide all users with point-and-click access to all systems and devices in the secure network. With one click, SDT Connector sets up a secure SSH tunnel from the client to the selected console server, establishes a port forward connection to the target network-connected host or serial connected device, and executes the client application used in communicating with the host.

6. SSH Tunnels and SDT Connector

6.1 Configuring for SSH Tunneling to Hosts

To set up the console server for SSH tunneled access a network attached host:

- Add the new host and the permitted services using the **Serial & Network: Network Hosts** menu as detailed in section 4.4 **Network Hosts**. Only these permitted services will be forwarded by SSH to the host. All other services (TCP/UDP ports) will be blocked.

Note: Some TCP Ports used by SDT in the console server include:

- 22 SSH (All SDT tunneled connections)
- 23 Telnet on local LAN (forwarded inside tunnel)
- 80 HTTP on local LAN (forwarded inside tunnel)
- 3389 RDP on local LAN (forwarded inside tunnel)
- 5900 VNC on local LAN (forwarded inside tunnel)
- 73XX RDP over serial from local LAN – where XX is the serial port number (i.e. 7301 to 7348 on a 48-port console server)
- 79XX VNC over serial from local LAN – where XX is the serial port number



System Name: b093-008-2e4u-v Model: B093-008-2E4U-V Firmware: 4.0.0u1
Uptime: 0 days, 0 hours, 13 mins, 26 secs Current User: root



Serial & Network: Network Hosts

Manage

Status

- Port Access
- Active Users
- Statistics
- Support Report
- Syslog
- UPS Status
- RPC Status
- LLDP/CDP Neighbors
- Environmental Status
- Dashboard

Serial & Network

- Serial Port
- Users & Groups
- Authentication
- Network Hosts
- Trusted Networks
- IPsec VPN
- OpenVPN
- PPTP VPN
- Cascaded Ports
- UPS Connections
- RPC Connections
- Environmental
- Managed Devices
- IP Passthrough

Alerts & Logging

System

- Administration

IP Address/DNS Name
The host's IP Address or DNS name.

Host Name
A descriptive name to identify the host.

Description/Notes
A brief description of the host.

Permitted Services

- 22/tcp (ssh) - 0
- 23/tcp (telnet) - 0
- 80/tcp (http) - 0
- 443/tcp (https) - 0
- 1494/tcp (ica) - 0
- 3389/tcp (rdp) - 0
- 5900/tcp (vnc) - 0

TCP

UDP Port

level 0 - Disabled

The TCP services available from this host.

Device Settings

Device Type
Specify the device type.

- Add new Users using the **Serial & Network: Users & Groups** menu as detailed in 4.4 **Network Hosts**. Users can be authorized to access the console server ports and specified network-attached hosts. To simplify configuration, the Administrator can first set up Groups with group access permissions, then assign Users to those Group(s).

6.2 SDT Connector Client Configuration

The SDT Connector client works with all Tripp Lite console servers. Each of these remote console servers have an embedded OpenSSH-based server, which can be configured to port forward connections from the SDT Connector client to hosts on their local network, as detailed in the previous chapter. The SDT Connector can also be pre-configured with access tools and applications available to be run when access to a particular host has been established.

SDT Connector can connect to the console server using alternate OOB access. It can also access the console server itself and access devices connected to serial ports on the console server.

6. SSH Tunnels and SDT Connector

6.2.1 SDT Connector Client Installation

The SDT Connector set up program (**SDTConnector Setup-1.n.exe** or **sdtcon-1.n.tar.gz**) is included on the CD supplied with your Tripp Lite console server product.

Run the set-up program.

Note: For Windows clients, the *SDTConnectorSetup-1.n.exe* application will install the *SDT Connector 1.n.exe* and the config file *defaults.xml*. If there is already a config file on the Windows PC, then it will not be overwritten. To remove the earlier config file, run the *regedit* command and search for "SDT Connector", then remove the directory with this name.

For Linux and other UNIX clients, **SDTConnector.tar.gz** application will install the **sdtcon-1.n.jar** and the config file **defaults.xml**.

Once the installer completes, you will have a working SDT Connector client installed on your machine and an icon on your desktop:



Click the SDT Connector icon on your desktop to start the client.

Note: SDT Connector is a Java application, so it must have a Java Runtime Environment (JRE) installed. It will install on Windows 2000 and later and on most Linux platforms. Solaris platforms are also supported. However, they must have Firefox installed. SDT Connector can run on any system with Java 1.4.2 and above installed, but it assumes the web browser is Firefox, and that *xterm -e telnet* opens a telnet window.

6.2.2 Configuring a New Gateway in the SDT Connector Client

To create a secure SSH tunnel to a new console server:

- Click the New Gateway  icon or select the **File: New Gateway** menu option.
- Enter the **IP** or **DNS Address** of the console server and the SSH port that will be used (typically 22).

Note: If SDT Connector is connecting to a remote console server through the public Internet or routed network you will need to:

- Determine the public IP address of the console server (or of the router / firewall that connects the console server to the Internet) as assigned by the ISP. One way to find the public IP address is to access / or / from a computer on the same network as the console server and note the reported IP address.
- Set port forwarding for TCP port 22 through any firewall/NAT/router located between SDT Connector and the console server so it points to the console server. For port forwarding instructions for a range of routers, visit <http://www.portforward.com>. Also, you can use the Open Port Check tool at <http://www.canyouseeme.org> to check whether port forwarding through local firewall/NAT/router devices has been properly configured.
- Enter the **Username** and **Password** of a user on the gateway that has been enabled to connect via SSH and/or create SSH port redirections.

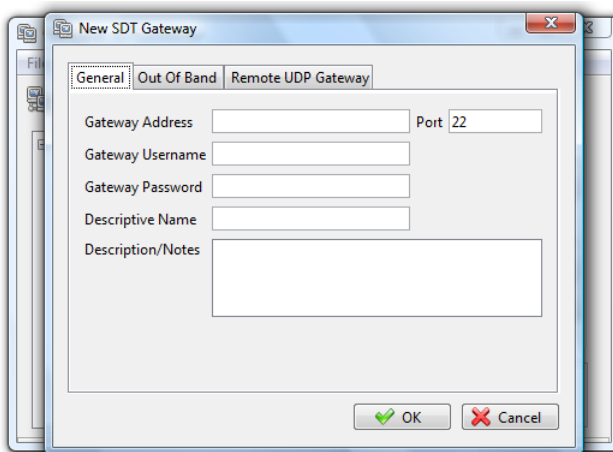

6. SSH Tunnels and SDT Connector

- Optionally, enter a **Descriptive Name** to display, instead of the IP or DNS address, and any **Notes** or a **Description** of this gateway (such as its firmware version, site location or anything special about its network configuration).
- Click **OK** and an icon for the new gateway will now appear in the **SDT Connector** home page.

Note: For an SDT Connector user to access a console server (and access specific hosts or serial devices connected to that console server), that user must first be set up on the console server, and must be authorized to access the specific ports / hosts (refer to **5. Firewall, Failover and OOB Access**). Only these permitted services will be forwarded by SSH to the Host. All other services (TCP/UDP ports) will be blocked.

6.2.3 Auto-Configure SDT Connector Client with the User's Access Privileges

Each user on the console server has an access profile configured with access privileges to specific connected hosts and serial port devices. This configuration can be auto-uploaded into the SDT Connector client:

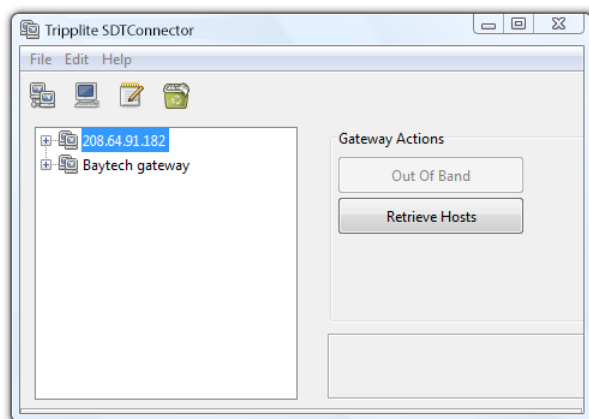

- Click on the new gateway icon and select **Retrieve Hosts**. This will:
 - o Configure access to network-connected hosts the user is authorized to access and set up (for each of these Hosts), the services (e.g. HTTPS, IPMI2.0) and the related IP ports being redirected.
 - o Configure access to the console server itself (this is displayed as a Local Services host).
 - o Configure access with the enabled services for the serial port devices connected to the console server.

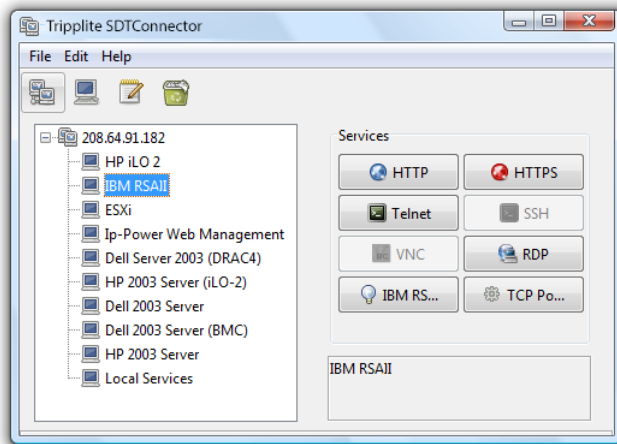

Note: The Retrieve Hosts function auto-configures all user classes (i.e. they can be members of user or admin or some other group or no group). The SDT Connector will not auto-configure the root; it is recommended the account only be used for initial configuration and for adding an initial Administrator account to the console server.

6. SSH Tunnels and SDT Connector

6.2.4 Make an SDT Connection Through the Gateway to a Host

Simply **point** at the host to be accessed, and **click** on the service to be used in accessing that host. The SSH tunnel to the gateway is automatically established, the appropriate ports redirected through to the host and the appropriate local client application is launched pointing at the local endpoint of the redirection:

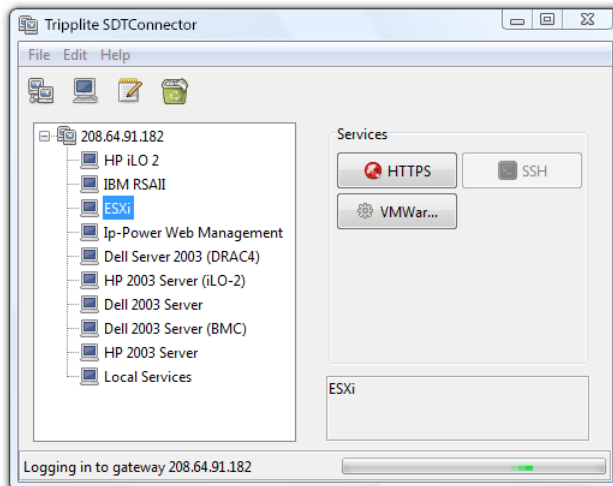

Note: The SDT Connector client can be configured with an unlimited number of gateways. Each gateway can be configured to port forward an unlimited number of locally networked hosts. Similarly, there is no limit on the number of SDT Connector clients who can be configured to access the gateway. Nor are there limits on the number of host connections that an SDT Connector client can concurrently have open through the one gateway tunnel.

There is a limit on the number of SDT Connector SSH tunnels that can be open at the same time on a particular gateway. Tripp Lite console servers support at least 50 concurrent connections. For example, a site with a Tripp Lite gateway can have up to 50 users securely controlling an unlimited number of network attached computers and devices (servers, routers, etc.) at that site, at any time.

Tripp Lite console servers support hundreds of simultaneous client tunnels.

6.2.5 Manually Adding Hosts to the SDT Connector Gateway

For each gateway, you can manually specify the network-connected hosts accessed through that console server. For each host, specify the services used in communicating with the host.

- Select the newly added gateway and click the host icon  to create a host that is accessible via the gateway. Alternately, you can select **File: New Host**.

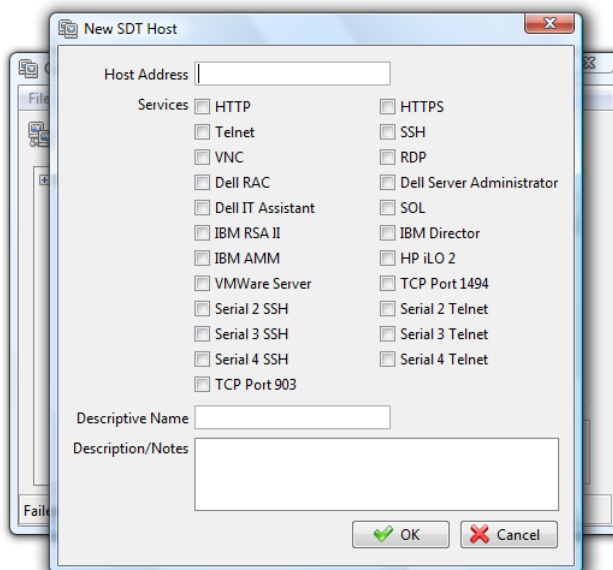

6. SSH Tunnels and SDT Connector

- Enter the IP or DNS **Host Address** (if this is a DNS address, it must be resolvable by the gateway).
- Select which **Services** are to be used in accessing the new host. A range of service options are pre-configured in the default SDT Connector client (RDP, VNC, HTTP, HTTPS, Dell RAC, VMware, etc.).
- Optionally, enter a **Descriptive Name** for the host to display (instead of the IP or DNS address) and any **Notes** or **Description** of this host (such as its operating system/release, or anything special about its configuration).
- Click **OK**.

6.2.6 Manually Adding New Services to the New Hosts

To extend the range of services that can be used when accessing hosts with SDT Connector:

- Select **Edit: Preferences** and click the **Services** tab. Click **Add**.
- Enter a **Service Name** and click **Add**.
- Under the **General** tab, enter the TCP Port that this service runs on (e.g. 80 for HTTP). Optionally, select the client to access the local endpoint of the redirection.

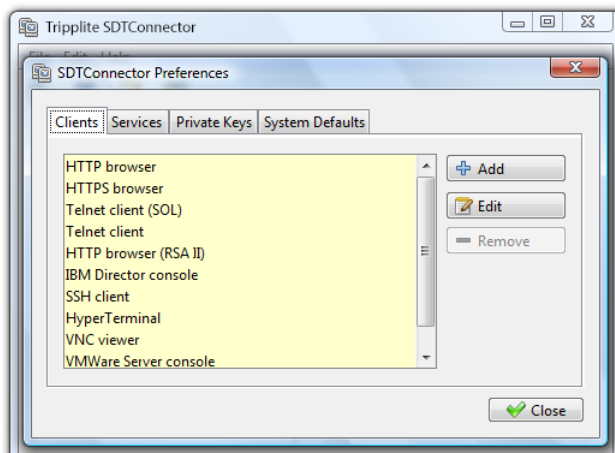

- Select which **Client** application is associated with the new service. A range of client application options are pre-configured in the default SDT Connector (RDP client, VNC client, HTTP browser, HTTPS browser, Telnet client, etc.). If you wish to add new client applications to this range, proceed to **6.2.7 Adding a Client to Be Started for the New Service**, then return to this step.

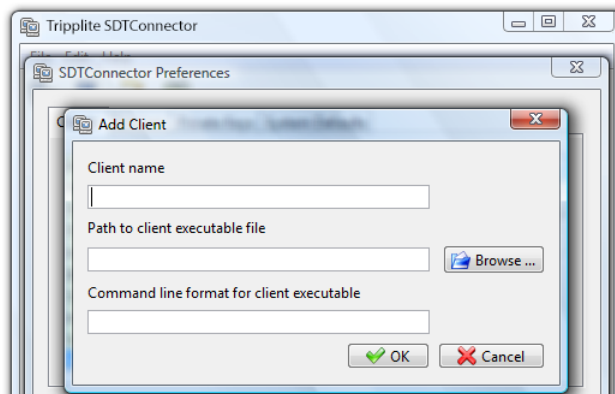

- Click **OK**, and then **Close**.

A service typically consists of a single SSH port redirection and a local client to access it. However, it may consist of several redirections, some or all of which may have clients associated with them.

One example of this is the Dell RAC service. The first redirection is for the HTTPS connection to the RAC server. The RAC server has a client associated with it (web browser) that is launched immediately upon clicking the button for this service.

6. SSH Tunnels and SDT Connector

The second redirection is the VNC service that the user may choose to later launch from the RAC web console. It is automatically loads in a Java client served through the web browser, so it does not need a local client associated with it.

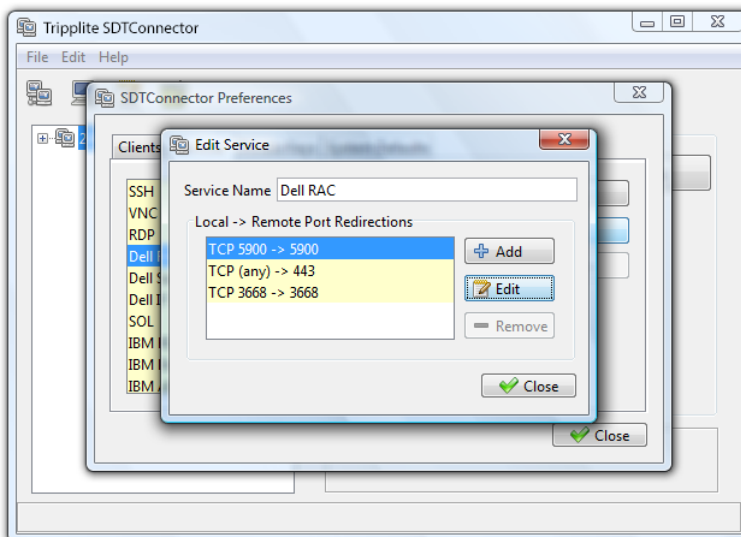

- On the Add Service screen, you can click **Add** as many times as needed to add multiple new port redirections and associated clients.

You may also specify **Advanced** port redirection options:

- Enter the local address to bind to when creating the local endpoint of the redirection. It is not usually necessary to change this from “localhost”.
- Enter a local TCP port to bind to when creating the local endpoint of the redirection. If this is left blank, a random port will be selected.

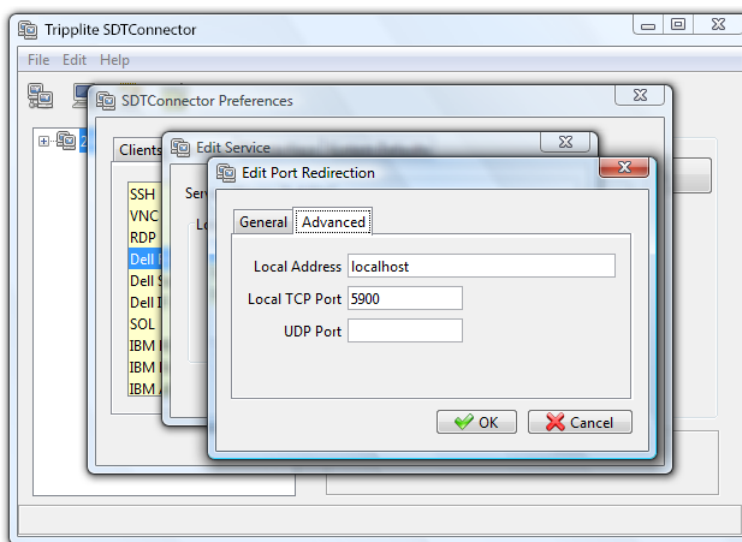

Note: SDT Connector can also tunnel UDP services. SDT Connector tunnels the UDP traffic through the TCP SSH redirection, effectively making it is a tunnel within a tunnel.

Enter the UDP port on which the service is running on the host. This will also be the local UDP port the SDT Connector binds to as the local endpoint of the tunnel.

For UDP services, you will need to specify a TCP port under the General tab. This will be an arbitrary TCP port that is not in use on the gateway. An example of this is the SOL Proxy service. It redirects local UDP port 623 to remote UDP port 623 over the arbitrary TCP port 6667.

6. SSH Tunnels and SDT Connector

6.2.7 Adding a Client Program to Be Started for the New Service

Clients are local applications that may be launched when a related service is clicked. To add to the pool of client programs:

- Select **Edit: Preferences** and click the **Client** tab. Click **Add**.

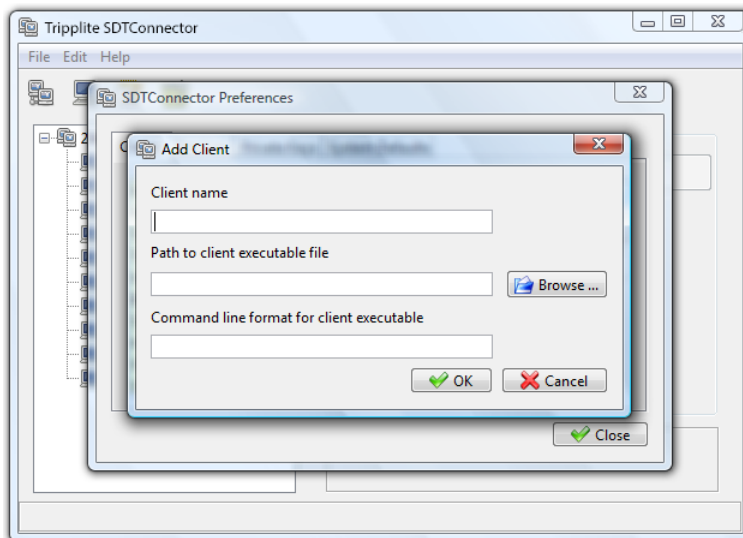

- Enter a **Name** for the client. Enter the Path to the executable file for the client (or click **Browse** to locate the executable).
- Enter a **Command Line** associated with launching the client application. SDT Connector typically launches a client using command line arguments to point it at the local endpoint of the redirection. There are three special keywords for specifying the command line format. When launching the client, SDT Connector substitutes these keywords with the appropriate values:

%path% is path to the executable file, i.e. the previous field.

%host% is the local address to which the local endpoint of the redirection is bound, i.e. the Local Address field for the Service redirection Advanced options.

%port% is the local port to which the local endpoint of the redirection is bound, i.e. the Local TCP Port field for the Service redirection Advanced options. If this port is unspecified (i.e. "Any"), the appropriate randomly selected port will be substituted.

For example, SDT Connector is preconfigured for Windows installations with a HTTP service client that will connect with whichever local browser the local Windows user has configured as the default. Otherwise, the default browser used is Firefox:

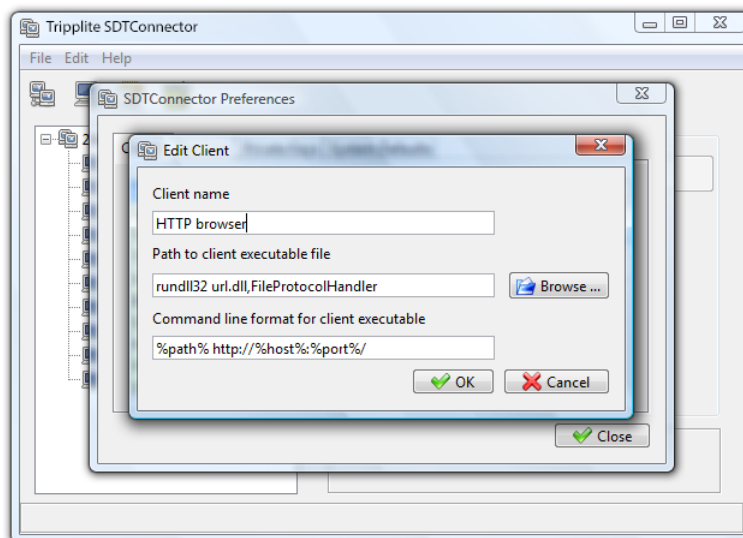

6. SSH Tunnels and SDT Connector

Also, some clients are launched in a command line or terminal window. The telnet client is an example of this. As such, the “Path to client executable file” is **telnet** and the “Command line format for client executable” is **cmd /c start %path% %host% %port%**:

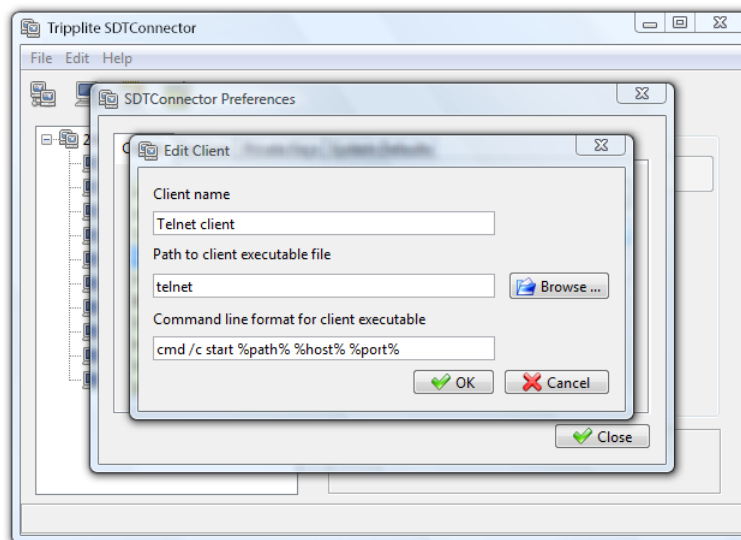

- Click **OK**.

6.2.8 Dial-In Configuration

If the client PC is dialing in to the Local/Console port on the console server, you will need to set up a dial-in PPP link:

- Configure the console server for dial-in access (refer to **5.2.1 Configuring Dial-In PPP**).
- Set up the PPP client software at the remote User PC.

Once you have a dial-in PPP connection established, you can set up the secure SSH tunnel from the remote Client PC to the console server.

6. SSH Tunnels and SDT Connector

6.3 SDT Connector to Management Console

SDT Connector can also be configured for browser access the gateway's Management Console – and for Telnet or SSH access to the gateway command line. For these connections to the gateway itself, you must configure **SDT Connector** to access the gateway (itself) by setting the Console server up as a host, and then configuring the appropriate services:

- Launch **SDT Connector** on your PC. Assuming you have already set up the console server as a **Gateway** in your **SDT Connector** client (with **username / password**, etc.), select this newly added **Gateway** and click the Host icon to create a host. Alternately, select **File: New Host**
- Enter 127.0.0.1 as the **Host Address** and provide details in **Descriptive Name/Notes**. Click **OK**.

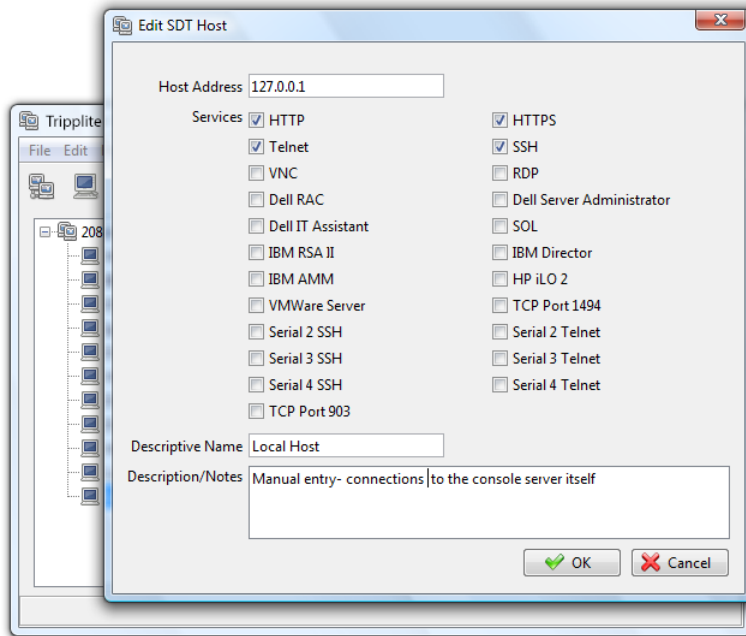

- Click the **HTTP** or **HTTPS** services icon to access the gateway's management console, and/or click **SSH** or **Telnet** to access the gateway command line console.

Note: To enable SDT access to the gateway console, you must configure the console server to allow port forwarded network access.

With firmware version 3.3 and later, this can be done using the console server management Console. Simply browse to the console server and select the **Service Access** tab on the **System: Firewall** menu. Ensure **SSH Command Shell** is enabled on the network interface and any out of band interfaces.

With earlier firmware:

- Browse to the console server and select **Network Hosts** from **Serial & Network**. Click **Add Host**. In the **IP Address/DNS Name** field, enter 127.0.0.1 (this is the console server's network loopback address) and enter Loopback in **Description**.
- Remove all entries under **Permitted Services**, except those that will be used in accessing the management console (80/http or 443/https) or the command line (22/ssh or 23/telnet). Then scroll to the bottom and click **Apply**.
- By default, Administrators have gateway access privileges. For Users to access the gateway management console, you will need to provide those Users the required access privileges. Select **Users & Groups** from **Serial & Network**. Click **Add User**. Enter a **Username**, **Description** and **Password/Confirm**. Select 127.0.0.1 from **Accessible Host(s)** and click **Apply**.

6. SSH Tunnels and SDT Connector

6.4 SDT Connector: Telnet or SSH Connect to Serially Attached Devices

SDT Connector can also be used to access text consoles on devices that are attached to the console server's serial ports. For these connections, you must configure the SDT Connector client software with a service that will access the target gateway serial port, and then set the gateway up as a host:

- Launch **SDT Connector** on your PC. Select **Edit: Preferences** and click the **Services** tab. Click **Add**.
- Enter "**Serial Port 2**" in **Service Name** and click **Add**.
- Select **Telnet** client as the Client. Enter 2002 in **TCP Port**. Click **OK**, then Close and Close again.

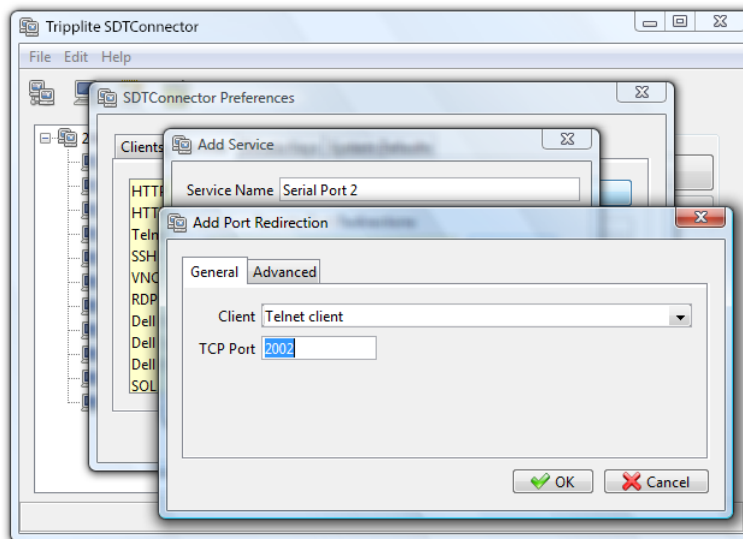

- Assuming you have already set up the target console server as a gateway in your SDT Connector client (with username / password, etc.), select this gateway and click the **Host** icon to create a host. Alternately, select **File: New Host**.
- Enter 127.0.0.1 as the **Host Address** and select **Serial Port 2** for service. In **Descriptive Name**, enter something along the lines of Loopback ports, or Local serial ports. Click **OK**.
- Click the **Serial Port 2** icon for Telnet access to the serial console on the device attached to serial port 2 on the gateway. To enable SDT Connector to access to devices connected to the gateway's serial ports, you must also configure the console server itself to allow port forwarded network access to itself, and enable access to the assigned serial port:
 - Browse to the console server and select **Serial Port** from **Serial & Network**.
 - Click **Edit** next to selected Port # (e.g. Port 2 if the target device is attached to the second serial port). Ensure the port's serial configuration is appropriate for the attached device.
 - Scroll down to **Console Server Setting** and select **Console Server Mode**. Check **Telnet** (or **SSH**). Scroll to the bottom and click **Apply**.
 - Select **Network Hosts** from **Serial & Network** and click **Add Host**.
 - In the **IP Address/DNS Name** field, enter 127.0.0.1 (this is the console server's network loopback address) and enter **Loopback** in **Description**.
 - Remove all entries under **Permitted Services**, select **TCP** and enter 200n in **Port**. This configures the telnet port enabled in the previous step, so for Port 2 you would enter 2002.
 - Click **Add**, then scroll to the bottom and click **Apply**.
 - By default, Administrators have gateway and serial port access privileges. For Users to access the gateway and serial port, you will need to provide those Users the required access privileges. Select **Users & Groups** from **Serial & Network**. Click **Add User**. Enter a **Username**, **Description** and **Password/Confirm**. Select 127.0.0.1 from **Accessible Host(s)** and select Port 2 from Accessible Port(s). Click **Apply**.

6. SSH Tunnels and SDT Connector

6.5 Using SDT Connector for Out-of-Band (OOB) Connection to the Gateway

SDT Connector can also be set up to connect to the console server (gateway) out-of-band (OOB). OOB access uses an alternate path for connecting to the gateway to that used for regular data traffic. OOB access is useful when the primary link to the gateway is unavailable or unreliable.

A gateway's primary link is typically a broadband Internet connection or Internet connection via LAN or VPN. Secondary out-of-band connectivity is provided by a dial-up or wireless modem directly attached to the gateway. Out-of-band access enables you to access the hosts and serial devices on the network, diagnose any connectivity issues, and restore the gateway's primary link.

In SDT Connector, OOB access is configured by providing the gateway's secondary IP address and communicating to the SDT Connector how to start and stop the OOB connection. Starting an OOB connection may be achieved by initiating a dial-up connection, or adding an alternate route to the gateway. SDT Connector allows for maximum flexibility in this regard by allowing you to provide your own scripts or commands for starting and stopping the OOB connection.

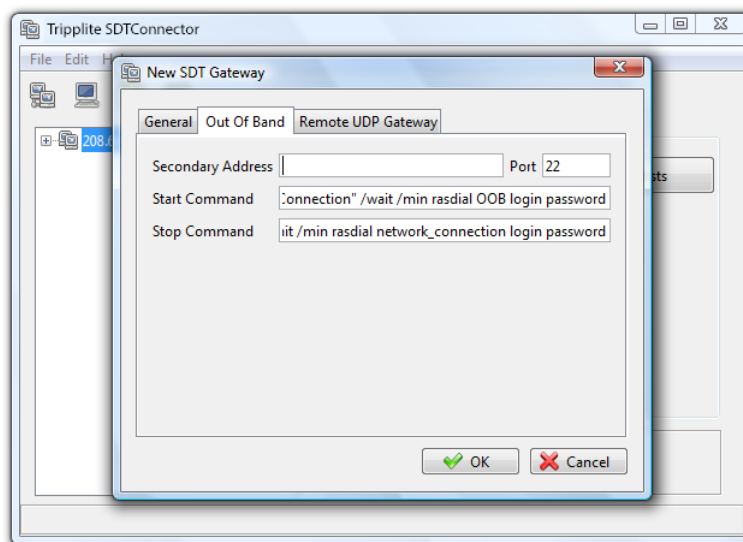

To configure SDT Connector for OOB access:

- When adding a new gateway or editing an existing gateway, select the **Out Of Band** tab.
- Enter the gateway's secondary OOB IP address (e.g., the accessible IP address used when dialed in directly). You also may modify the gateway's SSH port if it is not using the default of 22.
- In **Start Command**, enter the command or path to a script to start the OOB connection.
 - o To initiate a pre-configured dial-up connection under Windows, use the following Start Command:

```
cmd /c start "Starting Out of Band Connection" /wait /min rasdial network_connection login password
```

where `network_connection` is the name of the network connection as displayed in Control Panel -> Network Connections, **login** is the dial-in username, and **password** is the dial-in password for the connection.
 - o To initiate a pre-configured dial-up connection under Linux, use the following Start Command:

```
pon network_connection
```

where `network_connection` is the name of the connection.
- Enter the command or path to a script to stop the OOB connection in **Stop Command**.
 - o To stop a pre-configured dial-up connection under Windows, use the following Stop Command:

```
cmd /c start "Stopping Out of Band Connection" /wait /min rasdial network_connection /disconnect
```

where `network connection` is the name of the network connection as displayed in Control Panel -> Network Connections.
 - o To stop a pre-configured dial-up connection under Linux, use the following Stop Command:

```
poff network_connection
```

6. SSH Tunnels and SDT Connector

To make the OOB connection using SDT Connector:

- Select the gateway and click Out Of Band. The status bar will change color to indicate this gateway is now being accessed using the OOB link rather than the primary link.

When you connect to a service on a host behind the gateway, or to the console server gateway itself, SDT Connector will initiate the OOB connection using the provided Start Command. The OOB connection isn't stopped (using the provided Stop Command) until Out Of Band under Gateway Actions is clicked off, at which point the status bar will return to its normal color.

6.6 Importing (and Exporting) Preferences

To enable the distribution of pre-configured client configuration files, use the SDT Connector's Export/Import function:

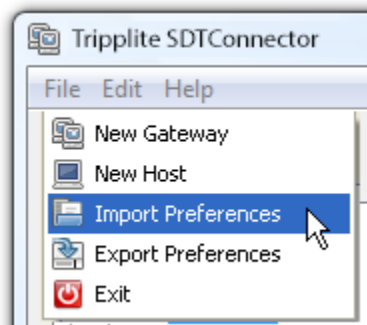

- To save a configuration .xml file (for backup or importing into other SDT Connector clients), select **File: Export Preferences** and select the location to save the configuration file.
- To import a configuration, select **File: Import Preferences** and select the .xml configuration file to be installed.

6.7 SDT Connector Public Key Authentication

SDT Connector can authenticate against an SSH gateway using your SSH key pair, rather than requiring you to enter your password. This is known as public key authentication.

To use public key authentication with SDT Connector, first add the public part of your SSH key pair to your SSH gateway:

- Ensure the SSH gateway allows public key authentication. This is typically the default behavior.
- If you do not already have a public/private key pair for your client PC (the one running SDT Connector) generate them using **ssh-keygen**, **PuTTYgen** or a similar tool. You may use RSA or DSA, however, it is important you leave the passphrase field blank:
 - PuTTYgen: <http://www.chiark.greenend.org.uk/~sgtatham/putty/download.html>
 - OpenSSH: <http://www.openssh.org/>
 - OpenSSH (Windows): <http://sshhwindows.sourceforge.net/download/>
- Upload the public part of your SSH key pair (this file is typically named **id_rsa.pub** or **id_dsa.pub**) to the SSH gateway. Otherwise, add to **.ssh/authorized keys** in your home directory on the SSH gateway.
- Next, add the private part of your SSH key pair (this file is typically named **id_rsa** or **id_dsa**) to SDT Connector. Click **Edit: Preferences: Private Keys: Add** and locate the private key file. Click **OK**.

You do not have to add the public part of your SSH key pair, it is calculated using the private key.

SDT Connector will now use public key authentication when connecting through the SSH gateway (console server). You may have to restart SDT Connector to shut down any existing tunnels that were established using password authentication.

Also, if you have a host behind the console server that you connect to by clicking the SSH button in SDT Connector, you may also wish to configure access for public key authentication. This configuration is entirely independent of SDT Connector and the SSH gateway. You must configure the SSH client that SDT Connector launches (e.g., Putty, OpenSSH) and the host's SSH server for public key authentication. Essentially, what you are using is SSH over SSH, and the two SSH connections are entirely separate.

6. SSH Tunnels and SDT Connector

6.8 Setting up SDT for Remote Desktop Access

Microsoft's Remote Desktop Protocol (RDP) enables the system manager to securely access and manages remote Windows computers – to reconfigure applications and user profiles, upgrade the server's operating system, reboot the machine, etc. Tripp Lite's Secure Tunneling uses SSH tunneling, so this RDP traffic is securely transferred through an authenticated and encrypted tunnel.

SDT with RDP also allows remote users to connect to Windows XP and later computers and to Windows 2000 Terminal Servers. Doing so allows access to all applications, files, and network resources (with full graphical interface). To set up a secure remote desktop connection, you must enable Remote Desktop on the target Windows computer that is to be accessed and then configure the RPD client software on the client PC.

6.8.1 Enable Remote Desktop on the Target Windows Computer to Be Accessed

To enable **Remote Desktop** on the Windows computer being accessed:

- Open **System** in the **Control Panel** and click the **Remote** tab.

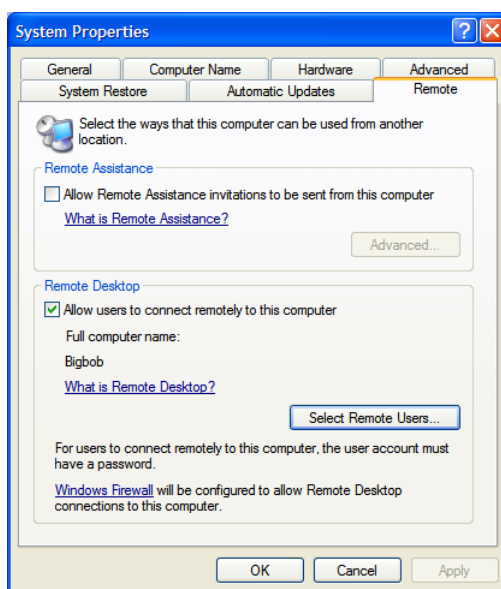

- Check **Allow users to connect remotely to this computer**.
- Click **Select Remote Users**.

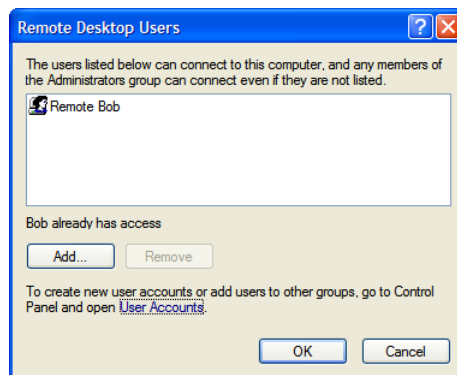

- To set the user(s) who can remotely access the system with RDP, click **Add** on the **Remote Desktop Users** dialog box.

Notes: If you need to set up new users for Remote Desktop access, open *User Accounts* in the Control Panel and proceed through the steps to assign the new user's name, password and account type (Administrator or Limited).

With Windows XP Professional and Vista, you have only one remote desktop session, and it connects directly to the Windows root console. With Windows Server 2008, you can have multiple sessions (with Server 2003 you have three sessions - the console session and two other general sessions).

When the remote user connects to the accessed computer on the console session, remote desktop automatically locks that computer so no other user can access the applications and files. When you return to your computer, you can unlock it by typing CTRL+ALT+DEL.

6. SSH Tunnels and SDT Connector

6.8.2 Configure the Remote Desktop Connection Client

With the Client PC securely connected to the console server (locally, remotely from the enterprise VPN, or a secure SSH internet tunnel or dial-in SSH tunnel), you can establish the remote desktop connection from the client. Simply enable the **Remote Desktop Connection** on the remote client PC, and then point it to the SDT Secure Tunnel port in the console server:

On a Windows client PC

Click **Start**. Point to **Programs**, then to **Accessories**, then **Communications**. Click **Remote Desktop Connection**.



In **Computer**, enter the appropriate IP Address and Port Number:

- Where there is a direct local or enterprise VPN connection, enter the console server's IP Address and the Port Number of the SDT Secure Tunnel for the console server serial port that is attached to the Windows computer to be controlled. For example, if the Windows computer is connected to serial Port 3 on a console server located at 192.168.0.50, then you would enter 192.168.0.50:7303.

Where there is an SSH tunnel over a dial-up PPP connection, public internet connection, or private network connection, simply enter the localhost as the IP address 127.0.0.1. For the port number, enter the source port you created when setting SSH tunneling /port forwarding (e.g., :1234).

Click **Option**. In the **Display** section, specify an appropriate color depth (e.g., for a modem connection it is recommended you not use over 256 colors). In **Local Resources**, specify the peripherals on the remote Windows computer that are to be controlled (printer, serial port, etc.).

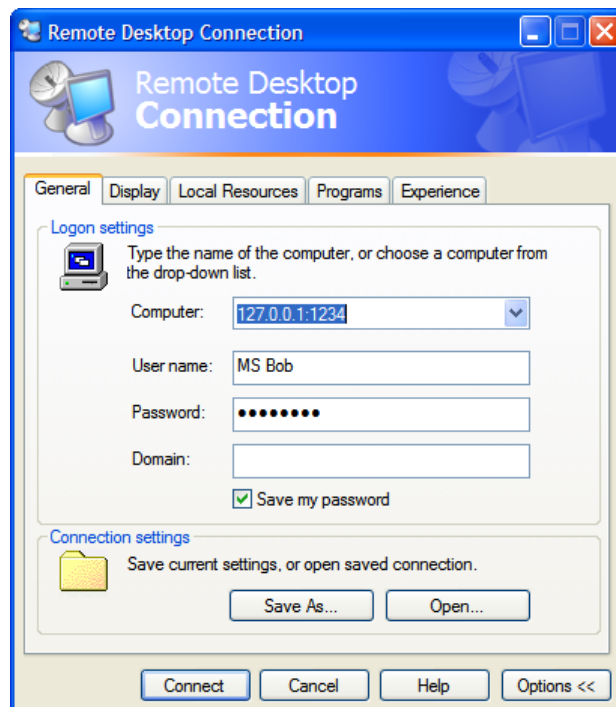

Click **Connect**.

6. SSH Tunnels and SDT Connector

Note: The Remote Desktop Connection software is pre-installed with Windows XP and later. For earlier Windows PCs, you will need to download the RDP client:

Go to the Microsoft Download Center site <http://www.microsoft.com/downloads/details.aspx?familyid=80111F21-D48D-426E-96C2-08AA2BD23A49&displaylang=en> and click the **Download** button.

This software package will install the client portion of Remote Desktop on Windows 95, Windows 98 and 98 Second Edition, Windows Me, Windows NT 4.0 and Windows 2000. When run, this software allows these older Windows platforms to remotely connect to a computer running the current Windows version.

On a Linux or UNIX client PC:

Launch the open source **rdesktop** client:

```
rdesktop -u windows-user-id -p windows-password -g 1200x950 ms-windows-terminal-server-host-name
```

Option	Description
-a	Color depth: 8, 16, 24
-r	Device redirection. i.e. Redirect sound on remote machine to local device i.e. -0 -r sound (MS/Windows 2003)
-g	Geometry: widthxheight or 70% screen percentage.
-p	Use -p - to receive password prompt.

You can use GUI front end tools like the GNOME Terminal Services Client **tsclient** to configure and launch the **rdesktop** client (using **tsclient** also enables you to store multiple configurations of **rdesktop** for connection to many servers).

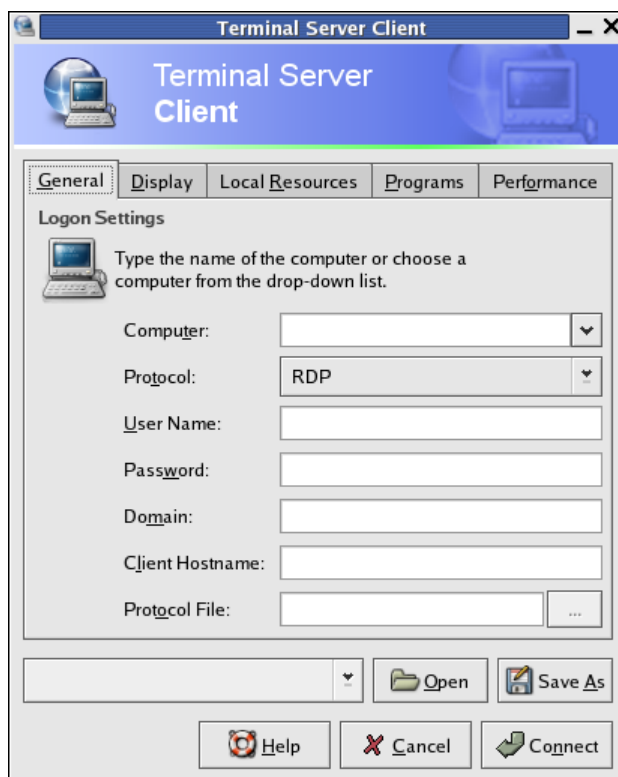

Note: The **rdesktop** client is supplied with Red Hat 9.0:

```
rpm -ivh rdesktop-1.2.0-1.i386.rpm
```

For Red Hat 8.0 or other distributions of Linux; download source, untar, configure, make, make then install.

rdesktop currently runs on most UNIX based platforms with the X Window System and can be downloaded from /

On a Macintosh client:

Download Microsoft's free Remote Desktop Connection client for Mac OS X

<http://www.microsoft.com/mac/otherproducts/otherproducts.aspx?pid=remotedesktopclient>

6. SSH Tunnels and SDT Connector

6.9 SDT SSH Tunnel for VNC

Alternately, with SDT and Virtual Network Computing (VNC), users and administrators can securely access and control Windows, Linux, Macintosh, Solaris and UNIX computers. There is a wide range of free popular VNC software options available (UltraVNC, RealVNC, TightVNC). To set up a secure VNC connection, you must install and configure the VNC Server software on the computer to be accessed, then install and configure the VNC Viewer software on the Viewer PC.

6.9.1 Install and Configure the VNC Server on the Computer to be Accessed

Virtual Network Computing (VNC) software enables users to remotely access computers running Linux, Macintosh, Solaris, UNIX, all versions of Windows and most other operating systems.

For Microsoft Windows servers (and clients):

Windows does not include VNC software, so you will need to download, install and activate a third party VNC Server software package:



RealVNC: <http://www.realvnc.com> is fully cross-platform, so a desktop running on a Linux machine may be displayed on a Windows PC, on a Solaris machine, or on any number of other architectures. There is a Windows server allowing you to view the desktop of a remote Windows machine on any of these platforms using exactly the same viewer. RealVNC was founded by members of the AT&T team who originally developed VNC.



TightVNC: <http://www.tightvnc.com> is an enhanced version of VNC. It has added features such as file transfer, performance improvements, and read-only password support. They have just recently included a video drive much like UltraVNC. TightVNC is still free, cross-platform (Windows UNIX and Linux) and compatible with the standard (Real) VNC.



UltraVNC: <http://ultravnc.com> is easy to use, fast and free VNC software that has pioneered and perfected features that the other flavors have consistently refused or been very slow to implement for cross platform and minimalist reasons. UltraVNC runs under Windows operating systems (95, 98, Me, NT4, 2000, XP, 2003) Download UltraVNC from Sourceforge's UltraVNC file list.

For Linux servers (and clients):

Most Linux distributions now include VNC Servers and Viewers and generally can be launched from the (Gnome/KDE etc) front end (e.g. with Red Hat Enterprise Linux 4, there is VNC Server software and a choice of Viewer client software). To launch:

- Select the **Remote Desktop** entry in the **Main Menu: Preferences** menu.
- Check the **Allow other users...** checkbox to allow remote users to view and control your desktop.



6. SSH Tunnels and SDT Connector

- To set up a persistent VNC server on Red Hat Enterprise Linux 4:
 - Set a password using **vncpasswd**.
 - Edit **/etc/sysconfig/vncservers**.
 - Enable the service with **chkconfig vncserver on**.
 - Start the service with service **vncserver start**.
 - Edit **/home/username/.vnc/xstartup** if you want a more advanced session than just **twm** and an xterm.

For Macintosh servers (and clients):

OSXvnc <http://www.redstonesoftware.com/vnc.html> is a robust, full-featured VNC server for Mac OS X that allows any VNC client to remotely view and/or control the Mac OS X machine. OSXvnc is supported by Redstone Software.

Most other operating systems (Solaris, HPUX, PalmOS, etc.) either come with VNC bundled, or have third party VNC software that you can download.

6.9.2 Install, Configure and Connect the VNC Viewer

VNC is truly platform-independent. A VNC Viewer on any operating system can connect to a VNC Server on any other operating system. There are Viewers (and Servers) from a wide selection of sources (e.g., UltraVNC TightVNC or RealVNC) for most operating systems. There are also a wealth of Java viewers available so any desktop can be viewed with a Java-capable browser (<http://en.wikipedia.org/wiki/VNC> lists many of the VNC Viewers sources).

- Install the VNC Viewer software and set it up for the appropriate speed connection.

Note: To make VNC faster, when you set up the Viewer:

- Set encoding to ZRLE (if you have a fast enough CPU)
 - Decrease color level (e.g., 64 bit)
 - Disable the background transmission on the Server or use a plain wallpaper (refer to <http://doc.uvnc.com> for detailed configuration instructions).
- To establish the VNC connection, first configure the VNC Viewer by entering the VNC Server IP address.

When the Viewer PC is connected to the console server through an SSH tunnel (over the public Internet, dial-in connection, or private network connection), enter **localhost** (or 127.0.0.1) as the IP VNC Server IP address. Use the source port you entered when setting SSH tunneling /port forwarding (in section **6.2.6 Manually Adding New Services to the New Hosts**) e.g., **:1234**.

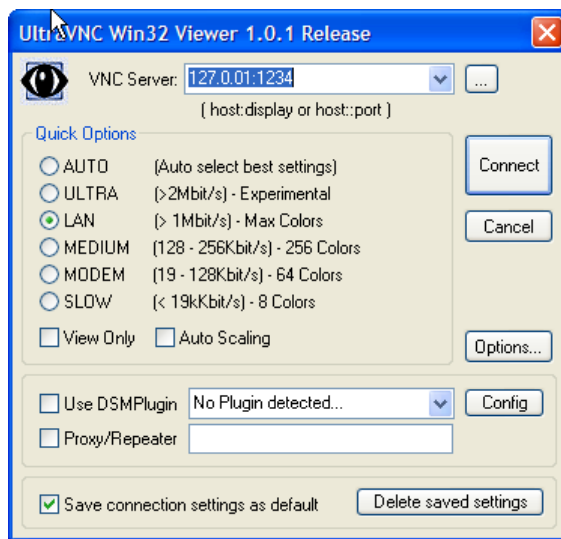

6. SSH Tunnels and SDT Connector

When the Viewer PC is directly connected to the console server (i.e. locally or remotely via VPN or dial-in connection) and the VNC Host computer is serially connected to the console server, enter the IP address of the console server unit with the TCP port that the SDT tunnel will use. The TCP port will be 7900 plus the physical serial port number. For example, with TCP ports 7901 to 7948, all traffic directed to port 79xx on the console server is tunneled through to port 5900 on the PPP connection on serial Port xx (e.g., for a Windows Viewer PC using UltraVNC connecting to a VNC Server, which is attached to Port 1 on a console server located 192.168.0.1).

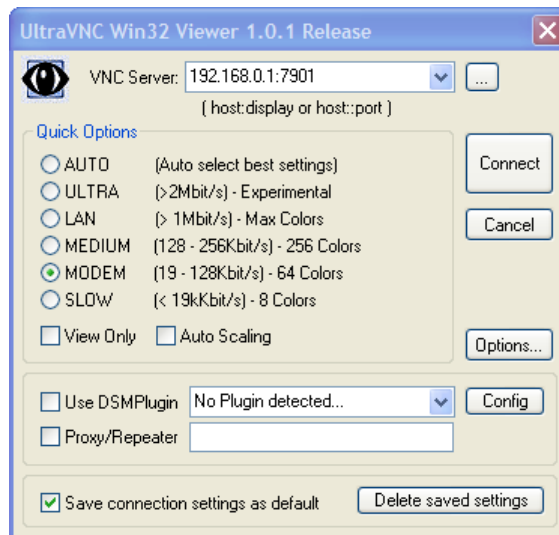

- You can then establish the VNC connection by simply activating the VNC Viewer software on the Viewer PC and entering the password.



Note: For general background reading on Remote Desktop and VNC access, we recommend the following:

- The Microsoft Remote Desktop How-To <http://www.microsoft.com/windowsxp/using/mobility/getstarted/remotaintro.mspx>
- The Illustrated Network Remote Desktop help page <http://theillustratednetwork.mvps.org/RemoteDesktop/RemoteDesktopSetupandTroubleshooting.html>
- What is Remote Desktop in Windows XP and Windows Server 2003? by Daniel Petri http://www.petri.co.il/what's_remote_desktop.htm
- Frequently Asked Questions about Remote Desktop <http://www.microsoft.com/windowsxp/using/mobility/rdfaq.mspx>
- Secure remote access of a home network using SSH, Remote Desktop and VNC for the home user <http://theillustratednetwork.mvps.org/RemoteDesktop/SSH-RDP-VNC/RemoteDesktopVNCandSSH.html>
- Taking your desktop virtual with VNC, Red Hat magazine / and /
- Wikipedia general background on VNC <http://en.wikipedia.org/wiki/VNC>

6.10 Using SDT to IP Connect to Hosts that are Serially Attached to the Gateway

Network (IP) protocols like RDP, VNC and HTTP can also be used for connecting to the host's serially connected devices through their COM port to the console server. To do this:

- Establish a PPP connection between the host and the gateway.
- Set up Secure Tunneling - Ports on the console server.
- Configure SDT Connector to use the appropriate network protocol to access IP consoles on the host devices that are attached to the Console server serial ports.

6. SSH Tunnels and SDT Connector

6.10.1 Establish a PPP Connection between the Host COM Port and Console Server

(This step is only necessary for serially connected computers)

Physically connect the COM port on the host computer to the serial port on the console server.

For non-Windows (Linux, UNIX, Solaris, etc.) computers, establish a PPP connection over the serial port. The online tutorial (<http://www.yolinux.com/TUTORIALS/LinuxTutorialPPP.html>) presents a selection of methods for establishing a PPP connection for Linux.

For Windows XP and 2003 computers, follow the steps below to set up an advanced network connection between the Windows computer and through its COM port to the console server. Both Windows 2003 and Windows XP Professional allow you to create a simple dial-in service which can be used for the Remote Desktop/VNC/HTTP/X connection to the console server:

- Open **Network Connections** in **Control Panel** and click the **New Connection Wizard**.

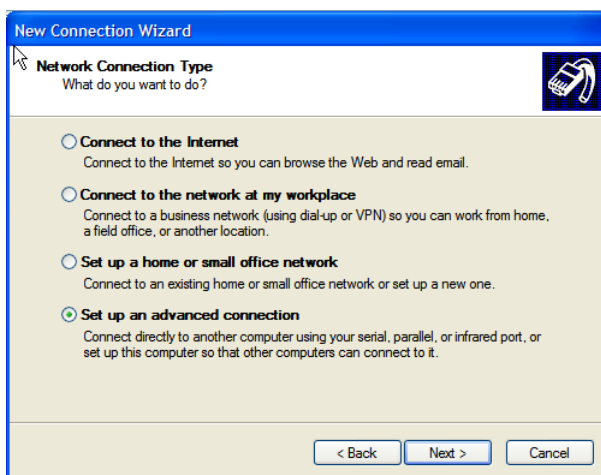

- Select **Set up an advanced connection** and click **Next**.
- On the **Advanced Connection Options** screen, select **Accept Incoming Connections** and click **Next**.
- Select the **Connection Device** (i.e. the serial COM port on the Windows computer that is connected to the console server). By default, select **COM1**. The COM port on the Windows computer should be configured to its maximum baud rate. Click **Next**.
- On the **Incoming VPN Connection Options** screen, select **Do not allow virtual private connections**. Click **Next**.

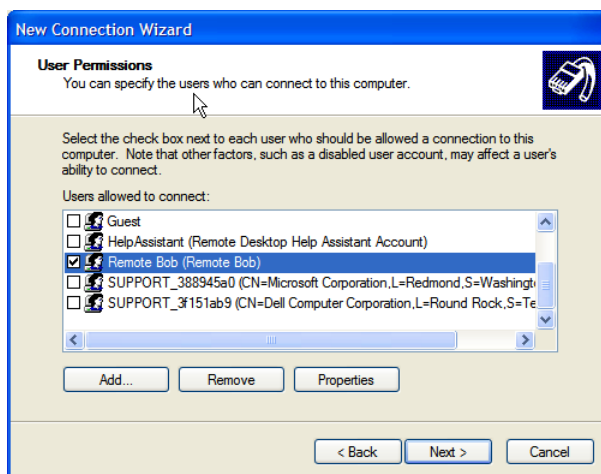

- Specify which users will be allowed to use this connection. These should be the same users who were given remote desktop access privileges in the earlier step. Click **Next**.

6. SSH Tunnels and SDT Connector

- On the **Network Connection** screen, select **TCP/IP**, then click **Properties**.

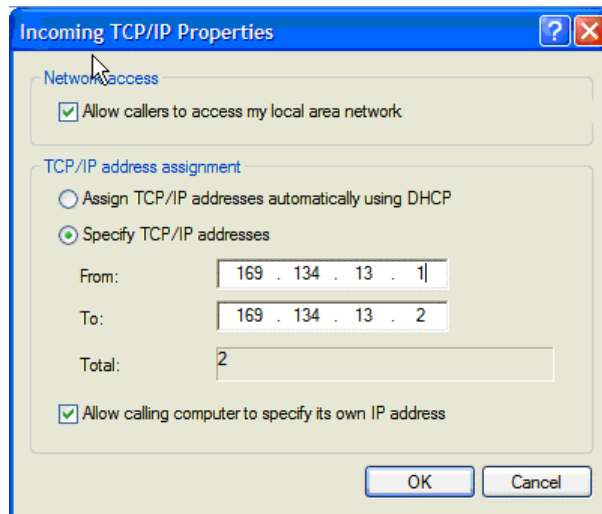

- Select **Specify TCP/IP addresses on the Incoming TCP/IP Properties** screen, then select **TCP/IP**. Assign a **From:** and a **To:** TCP/IP address. Click **Next**.

Note: You can choose any TCP/IP addresses as long as they are not used anywhere else on your network. The *From:* address will be assigned to the Windows XP/2003 computer and the *To:* address will be used by the console server. For simplicity, use the following IP address:

From: 169.134.13.1
To: 169.134.13.2

Alternately, you can set the advanced connection and access on the Windows computer to use the console server defaults:

- Specify 10.233.111.254 as the *From:* address.
- Select *Allow calling computer to specify its own address*.

Additionally, you can use the console server default username and password when you set up the new Remote Desktop User. In doing so, the user is granted permission to use the advanced connection to access the Windows computer:

- The console server default username is **portXX**, where **XX** is the serial port number on the console server.
- The default Password is **portXX**.

To use the defaults for a RDP connection to the serial port 2 on the console server, you will need to set up a Windows user named port02.

- When the PPP connection has been set up, a network icon will appear in the Windows task bar.

Note: The above notes describe setting up an incoming connection for Windows XP. The steps are similar for later versions with some slight differences:

- You need to check the box for **Always allow directly connected devices**.
- Also, the option for to **Set up an advanced connection** is not available in Windows 2003 if RRAS is configured. If RRAS has been configured, it is a simply task to enable the null modem connection for the dial-in configuration.

For earlier versions of Windows, follow the steps in the **For Windows XP and 2003 computers** section. To get to the **Make New Connection** button:

- For Windows 2000, click **Start** and select **Settings**. At the **Dial-Up Networking Folder**, click **Network and Dial-up Connections**, then click **Make New Connection**. You may need to first set up connection over the COM port using **Connect directly to another computer** before proceeding to **Set up an advanced connection**.
- For Windows 98, double-click **My Computer** on the Desktop, then open **Dial-Up Networking** and double-click.

6. SSH Tunnels and SDT Connector

6.10.2 Set Up SDT Serial Ports on Console Server

To set up RDP (and VNC) forwarding on the console server serial port that is connected to the Windows computer's COM port:

- Select the **Serial & Network: Serial Port** menu option and click **Edit** (for the particular Serial Port that is connected to the Windows computer COM port).
- On the SDT Settings menu, select **SDT Mode** (which will enable port forwarding and SSH tunneling) and enter a **Username** and **User Password**.

SDT Settings	
SDT Mode	<input type="radio"/> Enable access over SSH to a host connected to this serial port.
Username	<input type="text"/> The login name for PPP. The default is 'port01'
User Password	<input type="text"/> The login secret for PPP. The default is 'port01'
Confirm Password	<input type="text"/> Re-type the password for confirmation.

Notes:

- Enabling SDT will override all other configuration protocols on that port.
- If you leave the Username and Password fields blank, they default to portXX and portXX, where XX is the serial port number. For example, the default username and password for Secure RDP over Port 2 is port02.
- Ensure the console server **Common Settings** (Baud Rate, Flow Control) are the same as were set up on the Windows computer COM port and click **Apply**.
- RDP and VNC forwarding over serial ports is enabled by port. You can add users with access to these ports (or reconfigure User profiles) by selecting **Serial & Network: User & Groups** menu tag. Refer to **4.1 Configure Serial Ports** for more information.

6.10.3 Set Up SDT Connector to SSH Port Forward over Console Server Serial Port

In the SDT Connector software running on your remote computer, specify the gateway IP address of your console server and a username/password for a user you have set up on the console server that has access to the desired port.

Next, you need to add a new SDT Host. In the host address, put portxx where xx = the port you are connecting to. For example, for port 3, you would have a Host Address of: port03, then select the RDP Service check box.

6.11 SSH Tunneling Using Other SSH Clients (e.g. PuTTY)

It is recommend you use the SDT Connector client software supplied with the console server. However, there is also a wide selection of commercial and free SSH client programs that can provide the secure SSH connections to the console servers and secure tunnels to connected devices:

- **PuTTY** is a complete (though not the most user-friendly) freeware implementation of SSH for Win32 and UNIX platforms.
- **SSHTerm** is a useful open source SSH communications package.
- **SSH Tectia** is the leading end-to-end commercial communications security solution for enterprise.
- **Reflection for Secure IT** (formerly F-Secure SSH) is another good commercial SSH-based security solution.

6. SSH Tunnels and SDT Connector

The steps below show the establishment of an SSH tunneled connection to a network-connected device using the PuTTY client software.

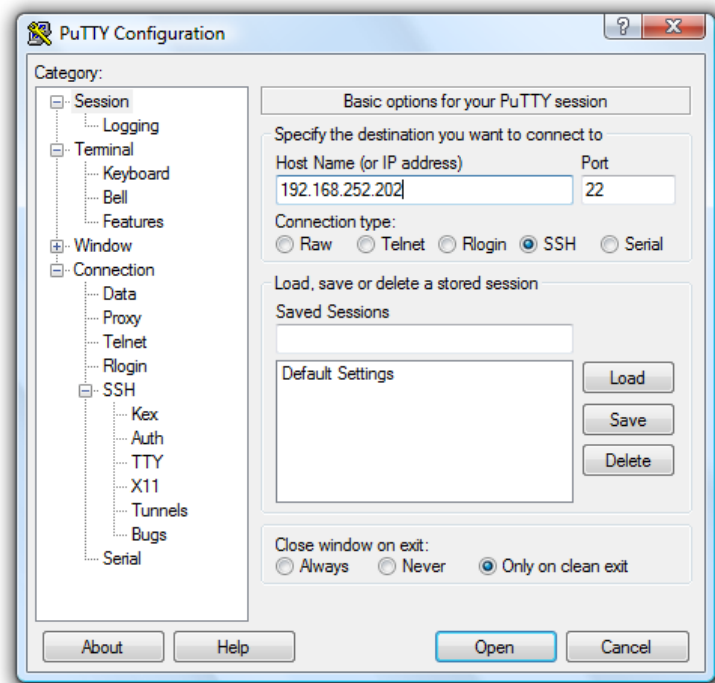

In the **Session** menu, enter the console server's IP address in the **Host Name** or **IP address** field.

- For dial-in connections, this IP address will be the Local address you assigned to the console server when you set it up as the Dial-In PPP Server.
- For Internet (or local/VPN connections) connections, this will be the public IP address of the console server.

Select the **SSH Protocol**. The port will be set as 22.

Go to the **SSH: Tunnels** menu. In **Add new forwarded port**, enter any frequently unused port number for the source port (e.g., 54321).

Set the **Destination: IP** details.

- If your destination device is network-connected to the console server using RDP, set the destination as **<Managed Device IP address/DNS Name>:3389**. If when setting up the Managed Device as Network Host on the console server, you specified its IP address to be 192.168.253.1 (or its DNS Name was **accounts.myco.intranet.com**), then specify the destination as **192.168.523.1:3389** (or **accounts.myco.intranet.com:3389**). Only devices that have been configured as networked hosts can be accessed using SSH tunneling (except by the "root" user who can tunnel to any IP address the console server can route to).

6. SSH Tunnels and SDT Connector

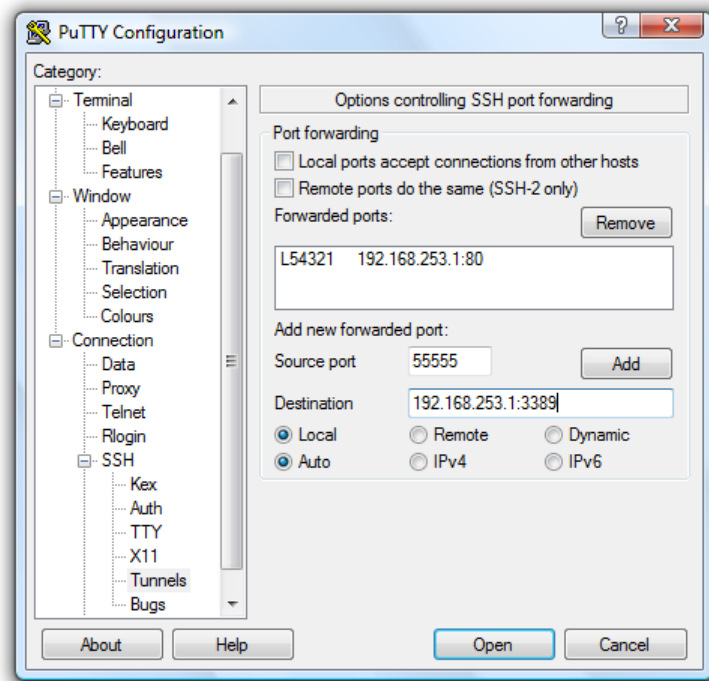

- If your destination computer is serially connected to the console server, set the destination as **<port label>:3389**. If the label you specified on the console server's serial port is **win2k3**, then specify the remote host as **win2k3:3389**. Alternately, you can set the destination as **portXX:3389**, where XX is the SDT enabled serial port number. For example, if port 4 on the console server is used to carry the RDP traffic, then specify **port04:3389**.

Note: http://www.jfitz.com/tips/putty_config.html provides useful examples on configuring PuTTY for SSH tunneling.

Select **Local** and click the **Add** button.

Click **Open** to SSH-connect the client PC to the console server. You will be prompted to enter the Username/Password for the console server user.

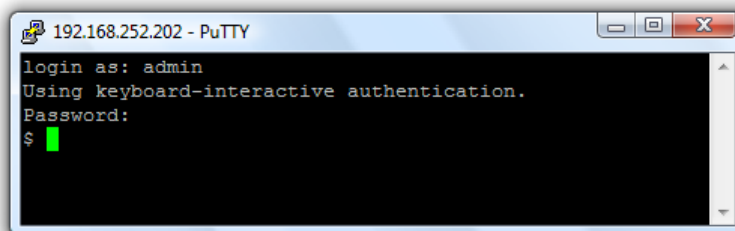

- If you are connecting as a User in the “users” group, you can only SSH tunnel to hosts and serial ports where you have specific access permissions.
- If you are connecting as an Administrator (in the “admin” group), you can connect to any configured host or serial ports (which has SDT enabled).

To set up the secure SSH tunnel for a HTTP browser connection to the managed device, specify port 80 (rather than port 3389 as was used for RDP) in the destination IP address.

To set up the secure SSH tunnel from the client (Viewer) PC to the console server for VNC, follow the steps above. When configuring the VNC port redirection, specify port 5900 in the destination IP address.

6. SSH Tunnels and SDT Connector

6.12 VNC Security

VNC access generally allows access to your whole computer, so maintaining strong security is important. VNC uses a random challenge-response system to provide the basic authentication that allows you to connect to a VNC server. This is reasonably secure and the password is not sent over the network.

Once connected, all subsequent VNC traffic is unencrypted and a malicious user could snoop your VNC session. VNC scanning programs are also available, which scan a subnet that searches for PCs listening on VNC ports.

Tunneling VNC over a SSH connection ensures all traffic is strongly encrypted. When using this method, no VNC port is ever open to the internet, so no one scanning for open VNC ports will be able to find your computers. When tunneling VNC over a SSH connection, the only port which you are opening on your console server is SDT port 22.

Sometimes it may be prudent to tunnel VNC through SSH, even when the viewer PC and the console server are both on the same local network.

7. Alerts, Auto-Response and Logging

This chapter describes the automated response, alert generation and logging features of the console server.

The Auto-Response facility extends on the basic Alert facility available in earlier (pre-V3.5) firmware revisions. With auto-response, the console server monitors selected serial ports, logins, the power status and environmental monitors and probes for check condition triggers. The console server will then initiate a sequence of actions in response to these triggers.

All console server models can also maintain log records of all access and communications with the console server and the attached serial devices. A log of all system activity is maintained as well as history of the status of any attached environmental monitors.

Some models can also log access and communications with network-attached hosts and maintain a history of the UPS and PDU power status.

- If port logs are to be maintained on a remote server, then the access path to this location needs to be configured. To do so, activate and set the desired levels of logging for each serial and/or network port (refer to section **7.6 Logging**) and/or section **8. Power, Environment and Digital I/O UPS**.

7.1 Configure Auto-Response

With the Auto-Response feature, a sequence of trigger actions is initiated in the event of a specified trigger condition (check condition). Subsequent resolve actions can also be performed when the trigger condition has been resolved.

To configure, first set the general parameters that will be applied to all auto-responses:

- Check **Log Events** on **Alerts & Logging: Auto-Response** to enable logging all auto-response activities.
- Check **Delay After Boot** to set any general delay to be applied after console server system boot before processing events.

The screenshot shows the TRIPP-LITE console server web interface. At the top, the system name is b093-008-2e4u-v, model is B093-008-2E4U-V, and firmware is 4.0.0u1. The uptime is 0 days, 0 hours, 18 mins, 38 secs, and the current user is root. Navigation icons for Dashboard, Manage Devices, Backup, and Log Out are visible.

The main content area is titled "Alerts & Logging: Auto-Response". On the left is a navigation menu with categories: Manage, Status, Serial & Network, Alerts & Logging (selected), and System. Under Alerts & Logging, "Auto-Response" is selected.

The main configuration area is divided into three sections:

- Configured Auto-Responses:** A table with columns: Name, Check Type, Status, Modify, Delete, and Cancel. A "New Auto-Response" button is located below the table.
- Global Auto-Response Settings:** Contains two settings:
 - Log Events:** A checkbox that is currently unchecked. Below it is the text "Log Events and actions related to Auto-Responses".
 - Delay after boot:** A text input field containing "120". Below it is the text "Delay after system boot before processing events".A "Save Settings" button is located below these settings.
- Auto-Response Logs:** A section showing "No Auto-Response Logs".

To configure a new auto-response:

- Select **New Auto-Response** in the **Configured Auto-Response** field. You will be presented with a new **Auto-Response Settings** menu.
- Enter a unique **Name** for the new auto-response.
- Specify the **Reset Timeout** for the time in seconds after resolution to delay before this Auto-Response can be triggered again.
- Check **Repeat Trigger Actions** to continue to repeat trigger action sequences until the check is resolved.

7. Alerts, Auto-Response and Logging

- Enter any required delay time before repeating trigger actions in **Repeat Trigger Action Delay**. This delay starts after the last action is queued.

System Name: b093-008-2e4u-v Model: B093-008-2E4U-V Firmware: 4.0.0u1
Uptime: 0 days, 0 hours, 19 mins, 38 secs Current User: root

Dashboard Manage Devices Backup Log Out

Alerts & Logging: Auto-Response

- Manage
- Status
- Serial & Network
- Alerts & Logging
 - Port Log
 - Auto-Response
 - SMTP & SMS
 - SNMP
- System
 - Administration
 - SSL Certificates
 - Configuration Backup
 - Firmware
 - IP
 - Date & Time
 - Dial
 - Firewall
 - Services
 - DHCP Server
 - Nagios
 - Configure Dashboard
 - Digital I/O

Auto-Response Settings

Name
Unique Name for this Auto-Response

Reset Timeout
Time in seconds after resolution to delay before this Auto-Response can be triggered again

Repeat Trigger Actions
Repeat Trigger actions until the check is resolved

Repeat Trigger Action Delay
Delay time before repeating trigger actions
The delay starts after the last action is queued

Disable Auto-Response at specific times
Allows Auto-Responses to be periodically disabled based on time and day

Check Conditions
Environmental
Digital I/O Input
UPS/Power Supply
UPS Status

Add a new check by selecting a check type from the left menu
[Return to Auto-Response List](#)

- Check **Disable Auto-Response at specific times**. You will be able to periodically disable auto-responses between specified times of day.

System Name: b093-008-2e4u-v Model: B093-008-2E4U-V Firmware: 4.0.0u1
Uptime: 0 days, 0 hours, 19 mins, 38 secs Current User: root

Dashboard Manage Devices Backup Log Out

Alerts & Logging: Auto-Response

- Manage
- Status
- Serial & Network
- Alerts & Logging
 - Port Log
 - Auto-Response
 - SMTP & SMS
 - SNMP
- System
 - Administration
 - SSL Certificates
 - Configuration Backup
 - Firmware
 - IP
 - Date & Time
 - Dial
 - Firewall
 - Services
 - DHCP Server
 - Nagios
 - Configure Dashboard
 - Digital I/O

Auto-Response Settings

Name
Unique Name for this Auto-Response

Reset Timeout
Time in seconds after resolution to delay before this Auto-Response can be triggered again

Repeat Trigger Actions
Repeat Trigger actions until the check is resolved

Repeat Trigger Action Delay
Delay time before repeating trigger actions
The delay starts after the last action is queued

Disable Auto-Response at specific times
Allows Auto-Responses to be periodically disabled based on time and day

Disable Auto-Response between the following times

Sunday	<input type="text" value="0"/> : <input type="text" value="00"/>	<input type="text" value="0"/> : <input type="text" value="00"/>
Monday	<input type="text" value="0"/> : <input type="text" value="00"/>	<input type="text" value="0"/> : <input type="text" value="00"/>
Tuesday	<input type="text" value="0"/> : <input type="text" value="00"/>	<input type="text" value="0"/> : <input type="text" value="00"/>
Wednesday	<input type="text" value="0"/> : <input type="text" value="00"/>	<input type="text" value="0"/> : <input type="text" value="00"/>

7. Alerts, Auto-Response and Logging

7.2 Check Conditions

To configure the condition that will trigger the auto-response:

- Click on the **Check Condition type** (e.g. **Environmental**, **UPS Status** or **ICMP ping**) to be configured as the trigger for this new auto-response in the **Auto-Response Settings** menu.

7.2.1 Environmental

To configure humidity or temperature levels as the trigger event:

- Click on **Environmental** as the **Check Condition**.

The screenshot shows the 'Alerts & Logging: Auto-Response' configuration window. The 'Auto-Response Settings' section includes fields for 'Name' (Site43A), 'Reset Timeout' (0), and a 'Repeat Trigger Actions' checkbox. The 'Environmental Check' section is expanded, showing a dropdown menu for 'Environmental Sensor' with options: Temperature, Comms Rack, Temperature, Humidity, CabinetR3, Temperature, and Humidity. The 'Trigger value for the check' field is empty. The 'Comparison type' section has radio buttons for 'Above Trigger Value' and 'Below Trigger Value'. The 'Hysteresis' field is set to 0. A 'Save Auto-Response' button is at the bottom.

- In the **Environmental Check** menu, select the specific **Environmental Sensor** to be checked for the trigger.
- Specify the **Trigger value** (in °C / °F for Temp and % for Humidity) that the check measurement must exceed or drop below to trigger the auto-response.
- Select **Comparison type** as being Above Trigger Value or Below Trigger Value to trigger.
- Specify any **Hysteresis** factor that is to be applied to environmental measurements (e.g., if an Auto-Response was set up with a trigger event of a temp reading above 49°C with a Hysteresis of 4, then the trigger condition would not be seen as having been resolved until the temp reading was below 45°C) .
- Check **Save Auto-Response**.

Note: Before configuring environmental checks as the trigger in auto-response, you will need first to configure the temperature and/or humidity sensors on your attached EMD.

7.2.2 Alarms and Digital Inputs

To set the status of any attached smoke or water sensors or digital inputs as the trigger event:

- Click on **Alarms / Digital Inputs** as the **Check Condition**.
- In the **Alarms / Digital Inputs Check** menu, select the specific **Alarm/Digital IO Pin** that will trigger the Auto-Response.
- Select **Trigger on Change** to trigger when alarm signal changes, or select to trigger when the alarm signal state changes to either a **Trigger Value** of **Open (0)** or **Closed (1)**.
- Check **Save Auto-Response**.

Note: Before configuring Alarms / Digital Inputs checks in Auto-Response, you first must configure the sensor/DIO that is to be attached to your EMD.

7. Alerts, Auto-Response and Logging

7.2.3 UPS/Power Supply

To use the properties of any attached UPS as the trigger event:

- Click on **UPS / Power Supply** as the **Check Condition**.
- Select **UPS Power Device Property** (Input Voltage, Battery Charge %, Load %, Input Frequency Hz or Temperature in °C) that will be checked for the trigger.
- Specify the **Trigger value** that the check measurement must exceed or drop below in order to trigger the auto-response.
- Select **Comparison type** as being **Above Trigger Value** or **Below Trigger Value** to trigger.
- Specify any **Hysteresis** factor that is to be applied to environmental measurements (e.g. if an auto-response was set up with a trigger event of a battery charge below 20% with a hysteresis of 5, then the trigger condition would not be seen as having been resolved until the battery charge was above 25%).
- Check **Save Auto-Response**.

Alerts & Logging: Auto-Response

Auto-Response Settings

Name
Unique Name for this AutoResponse

Reset Timeout
Time in seconds after resolution to delay before this AutoResponse can be triggered again

Repeat Trigger Actions
Repeat Trigger actions until the check is resolved

Check Conditions

- Environmental
- Alarms/Digital Inputs
- UPS/Power Supply**
- UPS Status
- Serial Login/Logout
- Serial Signal
- Serial Pattern
- ICMP Ping

UPS Power Check

Power Device Property to perform check on

Trigger value for the check

Comparison type
 Above Trigger Value
 Below Trigger Value
Determines what condition will cause the auto response to trigger

Hysteresis
Hysteresis factor applied to environmental measurements

Note: Before configuring UPS checks in auto-response, you first must configure the attached UPS.

7.2.4 UPS Status

To use the alert state of any attached UPS as the auto-response trigger event:

- Click on **UPS Status** as the **Check Condition**.
- Select the reported **UPS State** to trigger the auto-response (either **On Battery** or **Low Battery**). The auto-response will resolve when the UPS state returns to the "Online" state.
- Select which connected **UPS Device** to monitor and check **Save Auto-Response**.

Note: Before configuring UPS state checks in auto-response, you first must configure the attached UPS.

7. Alerts, Auto-Response and Logging

7.2.5 Serial Login, Signal or Pattern

To monitor serial ports and check for login/logout or pattern matches for auto-response triggers events:

- Click on **Serial Login/Logout** as the **Check Condition**. In the **Serial Login/Logout Check** menu, select **Trigger on Login** (to trigger when any user logs into the serial port) or **Trigger on Logout**. Specify the **Serial Port** to perform a check on.
- Click on **Serial Signal** as the **Check Condition**. In the **Serial Signal Check** menu, select the **Signal** (CTS, DCD, DSR) to trigger on the **Trigger** condition (either on serial signal change, or check level). Specify the **Serial Port** to perform a check on.
- Click on **Serial Pattern** as the **Check Condition**. In the **Serial Pattern Check** menu, select the **PCRE** and the serial line (TX or RX) and **Serial Port** to pattern check on.

Note: With serial pattern checks, you can assign to “Disconnect Immediately” all users from the serial being monitored in the event of a successful pattern match.

Alerts & Logging: Auto-Response

Auto-Response Settings

Name: Unique Name for this Auto-Response

Reset Timeout: Time in seconds after resolution to delay before this Auto-Response can be triggered again

Repeat Trigger Actions: Repeat Trigger actions until the check is resolved

Repeat Trigger Action Delay: Delay time before repeating trigger actions
The delay starts after the last action is queued

Disable Auto-Response at specific times: Allows Auto-Responses to be periodically disabled based on time and day

Check Conditions

- Environmental
- Digital I/O Input
- UPS/Power Supply
- UPS Status
- Serial Login/Logout
- Serial Signal
- Serial Pattern
- USB Console Status
- ICMP Ping
- Cellular Data
- Custom Check
- SMS Command
- CLI Session Event
- WebUI

Serial Pattern Check

Pattern: PCRE regular expression to match on

Match on TX: Match on characters transmitted by the Console Server to the connected device

Match on RX: Match on characters received by the Console Server from the connected device

Disconnect Immediately: On a successful pattern match disconnect users connected via this serial port

Serial Port

Select/Unselect all Ports.

<input type="checkbox"/> Port 1	<input type="checkbox"/> Port 2	<input type="checkbox"/> Port 3	<input type="checkbox"/> Port 4	<input type="checkbox"/> Port 5	<input type="checkbox"/> Port 6	<input type="checkbox"/> Port 7	<input type="checkbox"/> Port 8
<input type="checkbox"/> Rear USB 1	<input type="checkbox"/> Rear USB 2	<input type="checkbox"/> Rear USB 3	<input type="checkbox"/> Rear USB 4	<input type="checkbox"/> GPS			

Serial Port to perform check on

- Check **Save Auto-Response**.

Note: Before configuring serial port checks in auto-response, you first must configure the serial port in console server mode. Most serial port checks are not resolvable, so resolve actions will not be run.

7.2.6 USB Console Status

Note: USB port labels in the Web interface match the USB port labels printed on a console server, with two exceptions. Some console servers include discrete pairs of USB ports, which do not have printed labels. In this case, the Web interface denotes them as either Upper or Lower. That is, the Web interface lists them by their physical relationship to each other. Also, some console servers ship with an array of four USB ports. A limited number of these console servers have labels A – D printed by these ports, even though the Web interface will denote them as USB ports 1 – 4.

7. Alerts, Auto-Response and Logging

To monitor USB ports:

- Click **USB Console Status** as the **Check Condition**.
- Check the **Trigger on Connect** checkbox, the **Trigger on Disconnect** checkbox, or both checkboxes to set which actions trigger the auto-response.
- Check each USB port to be monitored (or click the **Select/Unselect all Ports** checkbox to select or deselect all USB ports).
- Click the **Save Auto-Response** button.
- Select an option from the **Add Trigger Action** list.
- Enter a unique action name for the trigger action being created.
- Set an action delay time. By default, this is 0 seconds.
- Enter the specific details of the selected action. For example, the Send Email action requires a recipient email address and allows for a subject and email text.
- Click the **Save New Action** button.

Note: USB console status checks are not resolvable. Trigger actions run but resolve actions do not.

7.2.7 ICMP Ping

To use a ping result as the auto-response trigger event:

- Click on **ICMP Ping** as the **Check Condition**.
- Specify which **Address to Ping** (i.e. IP address or DNS name to send ICMP Ping to) and which **Interface** to send ICMP Ping from (e.g. Management LAN or Wireless network).
- Set the **Check Frequency** (i.e. the time in seconds between checks) and the **Number** of ICMP Ping packets to send.
- Check **Save Auto-Response**.



System Name: b093-008-2e4u-v Model: B093-008-2E4U-V Firmware: 4.0.0u1
Uptime: 0 days, 0 hours, 19 mins, 38 secs Current User: root



Alerts & Logging: Auto-Response

- Manage
- Status
- Serial & Network
- Alerts & Logging**
 - Port Log
 - Auto-Response**
 - SMTP & SMS
 - SNMP
- System
 - Administration
 - SSL Certificates
 - Configuration Backup
 - Firmware
 - IP
 - Date & Time
 - Dial
 - Firewall
 - Services
 - DHCP Server
 - Nagios
 - Configure Dashboard
 - Digital I/O

Auto-Response Settings

Name
Unique Name for this Auto-Response

Reset Timeout
Time in seconds after resolution to delay before this Auto-Response can be triggered again

Repeat Trigger Actions
Repeat Trigger actions until the check is resolved

Repeat Trigger Action Delay
Delay time before repeating trigger actions
The delay starts after the last action is queued

Disable Auto-Response at specific times
Allows Auto-Responses to be periodically disabled based on time and day

Check Conditions

- Environmental
- Digital I/O Input
- UPS/Power Supply
- UPS Status
- Serial Login/Logout
- Serial Signal
- Serial Pattern
- USB Console Status

ICMP Ping Check

Address to Ping
Address to send ICMP Ping to. Can be an IP or a DNS name

Interface
Interface to send ICMP Ping from

Check Frequency
Time in seconds between checks

Number of Packets
Number of ICMP Ping packets to send

7. Alerts, Auto-Response and Logging

7.2.8 Link Layer Discovery Protocol (LLDP)

The Link Layer Discovery Protocol (LLDP) is a protocol that allows system administrators to glean information about devices physically connected to managed switches.

Using LLDP

The LLDP service is enabled through the **System > Services** page. When the service is enabled, the lldpd daemon is loaded and running. The **Service Access** tab controls which network interfaces are monitored by the lldpd daemon.

When LLDP is granted access to an interface, it will use that interface, even if the interface has been disabled via **System > IP**.

LLDP neighbors are visible through the **Status > LLDP Neighbors** page. This page shows neighbors are recognized and indicates the information the console manager is sending.

Note: Although the LLDP service can be granted access to non-Ethernet interfaces (for example, G3, G4 and PSTN dial-up interfaces), it currently ignores non-Ethernet interfaces.

Customising LLDP

The lldpcli shell client interacts with and configures the running LLDP service.

Persistent custom configuration changes can be added to the system through configuration files placed in /etc/config/lldpd.d/. Custom configuration files — which must have filenames ending with .conf — will be read and executed by lldpcli when the LLDP service starts.

Note: The /etc/ directory is read-only on Tripp Lite hardware. Most default configuration files otherwise stored in /etc/ are, on Tripp Lite hardware, in /etc/config/, which is writeable.

The default lldpd configuration file — lldpd.conf — is stored in /etc/config/ on Tripp Lite hardware. However, it is not safe as a store of custom configuration details. There are circumstances in which this file is regenerated automatically, in which case all customizations will be lost.

The etc/config/lldpd.d/ directory, which is also writable and created on first boot, is safe to write to. Any Custom LLDP configurations must be stored as *.conf files in this directory.

Security

When enabled, LLDP frames issued by a Tripp Lite Console Manager will reveal sensitive information, such as hostname and firmware version.

However, LLDP frames are not passed through by 802.3ab compliant switches, and Tripp Lite Console Managers have the LLDP service disabled by default.

Documentation

Both lldpd and lldpcli have standard manual pages. However, due to space constraints, these manual pages are not shipped with Tripp Lite hardware.

Both manual pages are available on the lldpd project web-site however:

man lldpd.

man lldpcli.

Note: Tripp Lite uses lldpd 0.9.2.

7.2.9 Cellular Data

This check monitors the inbound and outbound aggregate data traffic through the cellular modem as an auto-response trigger event.

- Click on **Cellular Data** as the **Check Condition**.

Note: Before configuring cellular data checks in auto-response, the internal cellular modem must be configured and detected by the console server.

7. Alerts, Auto-Response and Logging

7.2.10 Custom Check

This check allows users to run an assigned custom script with assigned arguments whose return value is used as an auto-response trigger event:

- Click on **Custom Check** as the **Check Condition**.
- Create an executable trigger check script file (e.g. `/etc/config/test.sh`):

```
#!/bin/sh
logger "A test script"
logger Argument1 = $1
logger Argument2 = $2
logger Argument3 = $3
logger Argument4 = $4
if [ -f /etc/config/customscript.0 ]; then
    rm /etc/config/customscript.0
    exit 7
fi
touch /etc/config/customscript.0
exit 1
```

Refer to the online FAQ for a sample web page html and other script file templates.

- Enter the **Script Executable** file name (e.g. `/etc/config/test.sh`).
- Set the **Check Frequency** (i.e. the time in seconds between re-running the script) and the **Script Timeout** (i.e. the maximum run-time for the script).
- Specify the **Successful Return Code**. An auto-response is triggered if the return code from the script is not this value.
- Enter **Arguments** that are to be passed to the script (e.g., with a web page html check script, these Arguments may specify the web page address/DNS and user logins).
- Check **Save Auto-Response**.



System Name: b093-008-2e4u-v Model: B093-008-2E4U-V Firmware: 4.0.0u1
Uptime: 0 days, 0 hours, 19 mins, 38 secs Current User: root



Alerts & Logging: Auto-Response

- Manage
- Status
- Serial & Network
- Alerts & Logging**
 - Port Log
 - Auto-Response
 - SMTP & SMS
 - SNMP
- System
 - Administration
 - SSL Certificates
 - Configuration Backup
 - Firmware
 - IP
 - Date & Time
 - Dial
 - Firewall
 - Services
 - DHCP Server
 - Nagios
 - Configure Dashboard
 - Digital I/O

Auto-Response Settings

Name
Unique Name for this Auto-Response

Reset Timeout
Time in seconds after resolution to delay before this Auto-Response can be triggered again

Repeat Trigger Actions
Repeat Trigger actions until the check is resolved

Repeat Trigger Action Delay
Delay time before repeating trigger actions
The delay starts after the last action is queued

Disable Auto-Response at specific times
Allows Auto-Responses to be periodically disabled based on time and day

Check Conditions

- Environmental
- Digital I/O Input
- UPS/Power Supply
- UPS Status
- Serial Login/Logout
- Serial Signal
- Serial Pattern
- USB Console Status
- ICMP Ping
- Cellular Data
- Custom Check

Custom Check

Script Executable
Script to execute when this action is triggered

Check Frequency
Time in seconds between checks

Script Timeout
Maximum run-time for this script.
Leave as 0 for unlimited

Successful Return Code
Trigger if the return code is not this value

Argument 1
Argument to pass to the script

Argument 2
Argument to pass to the script

7. Alerts, Auto-Response and Logging

7.2.11 SMS Command

An incoming SMS command from an assigned caller can trigger an auto-response:

- Click on **SMS Command** as the **Check Condition**.
- Specify which **Phone Number** (in international format) of the phone sending the SMS message. For multiple trusted SMS sources, separate the numbers with a comma.
- Set the **Incoming Message Pattern** (PCRE regular expression) to match to create a trigger event.

SMS Command Check

Please Select "Cellular Modem" under "SMS Settings" on the SMTP & SMS Page

Phone number
Phone number, or comma separated list of phone numbers, in international format without the +

Incoming Message Pattern
PCRE Regular expression to match within the incoming message

This check is not resolvable, Resolve actions will not be run

Note: The SMS command trigger condition can only be set if an internal cellular modem is detected.

7.2.12 Log In/Out Check

To configure web login/out as the trigger event:

- Click on the **Web UI Authentication** as the **Check Condition**.



System Name: b093-008-2e4u-v Model: B093-008-2E4U-V Firmware: 4.0.0u1
Uptime: 0 days, 0 hours, 19 mins, 38 secs Current User: root



Alerts & Logging: Auto-Response

Manage

Status

Serial & Network

Alerts & Logging

- Port Log
- Auto-Response
- SMTP & SMS
- SNMP

System

- Administration
- SSL Certificates
- Configuration Backup
- Firmware
- IP
- Date & Time
- Dial
- Firewall
- Services
- DHCP Server
- Nagios
- Configure Dashboard
- Digital I/O

Auto-Response Settings

Name
Unique Name for this Auto-Response

Reset Timeout
Time in seconds after resolution to delay before this Auto-Response can be triggered again

Repeat Trigger Actions
Repeat Trigger actions until the check is resolved

Repeat Trigger Action Delay
Delay time before repeating trigger actions
The delay starts after the last action is queued

Disable Auto-Response at specific times
Allows Auto-Responses to be periodically disabled based on time and day

Check Conditions

- Environmental
- Digital I/O Input
- UPS/Power Supply
- UPS Status
- Serial Login/Logout
- Serial Signal
- Serial Pattern
- USB Console Status

Web UI Login/Logout Check

Trigger on Login
Trigger when a user logs into the Web UI

Trigger on Logout
Trigger when a user logs out of the Web UI

Trigger on Authentication Error
Trigger when a user fails to authenticate to the Web UI

This check is not resolvable, Resolve actions will not be run

7. Alerts, Auto-Response and Logging

- Check **Trigger on Login (Logout)** to trigger when a user logs into (or out of) the Web UI.
- Check **Trigger on Authentication Error** to trigger when a user fails to authenticate to the Web UI.

Note: This check is not resolvable. Resolve actions will not run.

7.2.13 Network Interface Event

You may wish to configure a change in the network status as the trigger event (e.g., to send an alert or restart a VPN tunnel connection):

- Click on **Network Interface** as the **Check Condition**.

System Name: b093-008-2e4u-v Model: B093-008-2E4U-V Firmware: 4.0.0u1
Uptime: 0 days, 0 hours, 19 mins, 38 secs Current User: root

Dashboard Manage Devices Backup Log Out

Alerts & Logging: Auto-Response

Auto-Response Settings

Name
Unique Name for this Auto-Response

Reset Timeout
Time in seconds after resolution to delay before this Auto-Response can be triggered again

Repeat Trigger Actions
Repeat Trigger actions until the check is resolved

Repeat Trigger Action Delay
Delay time before repeating trigger actions
The delay starts after the last action is queued

Disable Auto-Response at specific times
Allows Auto-Responses to be periodically disabled based on time and day

Check Conditions

- Environmental
- Digital I/O Input
- UPS/Power Supply
- UPS Status
- Serial Login/Logout
- Serial Signal
- Serial Pattern
- USB Console Status

Interface Event Check

Interface
The interface to monitor for events

Events

- Down
- Starting
- Up
- Stopping

Events to trigger on.

This check is not resolvable, Resolve actions will not be run

- Select the **Interface** (Ethernet /Failover OOB Interface or Modem or VPN) to monitor.
- Check what type of network interface **Event** to trigger on (interface Down, Starting, Up or Stopping).

Note: This check is not resolvable. Resolve actions will not run.

7. Alerts, Auto-Response and Logging

7.2.14 Routed Data Usage Check

This check monitors the specified input interface for data usage being routed through the console server and out through another interface, such as the Internal Cellular Modem.

Routed data usage check is particularly useful in IP Passthrough mode to detect when the downstream router has failed over and is now routing via the console server's modem as a backup connection.

This check may be configured with these parameters:

Check Conditions

- Environmental
- Digital I/O Input
- UPS/Power Supply
- UPS Status
- Serial Login/Logout
- Serial Signal
- Serial Pattern
- ICMP Ping
- Cellular Data
- Custom Check
- SMS Command
- WebUI Authentication Event
- Network Interface Event
- Routed Data

Routed Data Usage Check

Interface Network Interface
The output interface to monitor for routed data usage.

Source MAC Address
Monitor routed data originating from this MAC address only.
Optional, leave blank to monitor any/all originating

Source IP Address
Monitor routed data originating from this IP address only.
Optional, leave blank to monitor any/all originating

Data Limit KBytes 100
The amount of data over the specified time period to trigger on

Time Period Minutes 2
Trigger when the routed data limit is reached within this time period.

Resolve Time Period Minutes 5
Resolve when no data is routed within this time period.

Save Auto-Response

Return to Auto-Response List

- The console server's incoming **Interface** to monitor.
- An optional **Source MAC/IP Address**, to monitor traffic from a specific host (e.g., the downstream router).
- A **Data Limit** threshold, the auto-response will trigger when this is hit in the specified **Time Period**.
- The auto-response will resolve if no matching data is routed for the **Resolve Period**.

7.3 Trigger Actions

To configure the sequence of actions to be taken in the event of the trigger condition:

- For an assigned auto-response with a defined check condition, click on **Add Trigger Action** (e.g. **Send Email** or **Run Custom Script**) to select the action type to be taken. Then configure the selected action (as detailed in the following sections).
- Each action is configured with an assigned **Action Delay Time** which specifies how long (in seconds) after the auto-response trigger event to wait before performing the action. You can add follow-on actions to create a sequence of actions that will be taken in the event of the one trigger condition.
- To edit (or delete) an existing action, click the **Modify** (or **Delete**) icon in the **Scheduled Trigger Action** table.

Trigger Actions

Add Trigger Action

- Send Email
- Send SMS
- Perform RPC Action
- Run Custom Script
- Send SNMP Trap
- Send Nagios Event

SMS Action

Action Name CEO alert
Unique name for this action

Action Delay Time 4800
Time after the Auto-Response triggers to perform this action

Phone number 18012353873
Phone number in international format, without the +

Message Text
\$TIMESTAMP: Critical UPS at G7 shed. Graceful shutdown pending

The text of the SMS to send. Longer messages will be split up

Save New Action

Scheduled Trigger Actions

Delay Time	Action Name	Action Type	Modify	Delete
0	Field SMS	sms		
600	Help Desk	snmp		
1800	Elevate	email		
5400	Shut down	rpc		

7. Alerts, Auto-Response and Logging

Note: A message text can be sent with Email, SMS and Nagios actions. This configurable message can include selected values:

`$AR_TRIGGER_VAL` = the trigger value for the check e.g. for UPS Status, it could be onbatt or battlow

`$AR_VAL` = the value returned by the check e.g. for ups status, it could be online/onbatt/battlow

`$AR_CHECK_DEV` = the device name of the device being checked e.g. for Alarm, the alarm name

`$TIMESTAMP` = the current timestamp

`$HOSTNAME` = the hostname of the console server

The default message text is: `$TIMESTAMP: This action was run - Check details: value $AR_VAL vs trigger value $AR_TRIGGER_VAL.`

7.3.1 Send Email

Click on **Send Email** as the **Add Trigger Action**. Enter a unique **Action Name** and set the **Action Delay Time**

Specify the **Recipient Email Address** for whom to send this email and the **Subject** of the email. For multiple recipients, you can enter comma-separated addresses.

Edit the **Email Text** message to send. Click **Save New Action**.

Note: An SMS alert can also be sent via an SMTP (email) gateway. You will need to specify the Recipient Email Address in the format specified by the gateway provider (e.g., for T-Mobile it is `phonenumber@tmomail.net`).

7.3.2 Send SMS

Click on **Send SMS** as the **Add Trigger Action**. Enter a unique **Action Name** and set the **Action Delay Time**.

Specify the **Phone number** that the SMS will be sent to in international format (without the +).

Edit the **Message Text** to send and click **Save New Action**.

Note: The SMS alert can only be sent if there is an internal cellular modem attached. However, an SMS alert can also be sent via SMTP SMS gateway, as described above.

7.3.3 Perform RPC Action

Click on **Perform RPC Action** as the **Add Trigger Action**. Enter a unique **Action Name** and set the **Action Delay Time**

Select a power **Outlet** and specify the **Action** to be performed (power ON, OFF or Cycle).

Click **Save New Action**.

7.3.4 Run Custom Script

Click on **Run Custom Script** as the **Add Trigger Action**. Enter a unique **Action Name**, and set the **Action Delay Time**.

Create a script file to execute when this action is triggered and enter the **Script Executable** file name (e.g., `/etc/config/action.sh`).

Set the **Script Timeout** (the maximum run-time for the script). Leave as 0 for unlimited.

Enter any **Arguments** that are to be passed to the script and click **Save New Action**.

7.3.5 Send SNMP Trap

Click on **Send SNMP Trap** as the **Add Trigger Action**. Enter a unique **Action Name**, and set the **Action Delay Time**.

Note: SNMP Trap actions are valid for Serial, Environmental, UPS and Cellular data triggers.

7. Alerts, Auto-Response and Logging

7.3.6 Send Nagios Event

Click on **Send Nagios Event** as the **Add Trigger Action**. Enter a unique **Action Name**, and set the **Action Delay Time**.

Edit the **Nagios Event Message** text to display on the Nagios status screen for the service.

Specify the **Nagios Event State** (OK, Warning, Critical or Unknown) to return to Nagios for this service.

Click **Save New Action**.

Note: To notify the central Nagios server of Alerts, NSCA must be enabled under System: Nagios and Nagios must be enabled for each applicable host or port.

7.3.7 Perform Interface Action

Click on **Perform Interface Action** as the **Add Trigger Action**. Enter a unique **Action Name**, and set the **Action Delay Time**.

Select the **Interface** (Modem or VPN service) and the **Action** (Start or Stop Interface) to be taken. You may wish to start an IPsec VPN service in response to an incoming SMS, or set up an OpenVPN tunnel whenever your Tripp Lite device fails over to use the cellular connection.

Delay Time	Action Name	Action Type	Modify	Delete
1	Restart VPN Service	conman		

Note: If any IPsec service or OpenVPN tunnel is to be controlled by the Network Interface Event Action, you will need to have checked the Control by Auto-Response box when configuring that service. If selected, the default state for the VPN tunnel / service will be down.

7.4 Resolve Actions

Actions can also be scheduled for when a trigger condition has been resolved:

- For an assigned auto-response with a defined trigger check condition, click on **Add Resolve Action** (e.g., **Send Email** or **Run Custom Script**) to select the action type to be taken.

Note: Resolve Actions are configured exactly the same as Trigger Actions, except the designated Resolve Actions are all executed on resolution of the trigger condition and there are no Action Delay Times set.

Action Name	Action Type	Modify	Delete
Notify client	email		
Close help desk ticket	nagios		

7. Alerts, Auto-Response and Logging

7.5 Configure SMTP, SMS, SNMP and/or Nagios Service for Alert Notifications

The auto-response facility enables remote alerts to be sent as Trigger and Resolve Actions. Before such alert notifications can be sent, you must configure the assigned alert service.

7.5.1 Send Email Alerts

The console server uses SMTP (Simple Mail Transfer Protocol) for sending the email alert notifications. To use SMTP, the Administrator must configure a valid SMTP server for sending the email:

- Select **Alerts & Logging: SMTP & SMS**.

System Name: b093-008-2e4u-v Model: B093-008-2E4U-V Firmware: 4.0.0u1
Uptime: 0 days, 0 hours, 41 mins, 57 secs Current User: root

Dashboard Manage Devices Backup Log Out

Alerts & Logging: SMTP & SMS

SMTP Server

Server
The outgoing mail server address.

Secure Connection None
If this server uses a secure connection, specify its type.

SMTP port
Specify the SMTP port. Default is 25

Sender
The 'from' address which will appear on the sent email.

Username
(Currently empty)
If this server requires authentication, specify the username.

Password
If this server requires authentication, specify the password.

Confirm
Re-enter the password.

Authentication Method Automatic
Allows authentication to be overridden should autodetection fail.

Subject Line
(Currently empty)
If this server requires a specific subject line, specify it here.

SMS Settings

- In the **SMTP Server** field, enter the IP address of the outgoing mail **Server**.
- If this mail server uses a **Secure Connection**, specify its type. You may also specify the IP port to use for SMTP. The default **SMTP Port** is 25.
- You may enter a **Sender** email address which will appear as the “from” address in all email notifications sent from this console server. Many SMTP servers check the sender’s email address with the host domain name to verify the address as authentic. It may be useful to assign an email address for the console server, such as consoleserver2@mydomain.com.
- You may also enter a **Username** and **Password** if the SMTP server requires authentication.
- Similarly can specify the specific Subject Line that will be sent with the email.
- Click **Apply** to activate SMTP.

7. Alerts, Auto-Response and Logging

7.5.2 Send SMS Alerts

With any model console server, you can use email-to-SMS services to send SMS alert notifications to mobile devices. Almost all mobile phone carriers provide an SMS gateway service that forwards email to mobile phones on their networks. A wide selection of SMS gateway aggregators provide email to SMS forwarding to phones on any carrier.

Alternately, if your console server has an embedded or externally attached cellular modem, you will be given the option to send the SMS directly over the carrier connection.

SMS via Email Gateway

To use SMTP SMS, the Administrator must configure a valid SMTP server for sending the email:

SMS Settings	
SMS Gateway	<input checked="" type="radio"/> Use an external SMS gateway
Cellular Modem	<input type="radio"/> Use an attached or internal Cellular Modem

SMS via Email Gateway	
Server	<input type="text"/> The outgoing SMTP SMS server address
Secure Connection	<input type="text" value="None"/> <input type="button" value="v"/> If this server uses a secure connection, specify its type.
SMTP port	<input type="text"/> Specify the SMTP port. Default is 25
Sender	<input type="text"/> The 'from' address which will appear on the sent email.
Username	<input type="text" value="(Currently empty)"/> If this server requires authentication, specify the username.
Password	<input type="text"/> If this server requires authentication, specify the password.
Confirm	<input type="text"/> Re-enter the password.
Authentication Method	<input type="text" value="Automatic"/> <input type="button" value="v"/> Allows authentication to be overridden should autodetection fail.
Subject Line	<input type="text" value="(Currently empty)"/> If this server requires a specific subject line, specify it here.

- In the **SMTP Settings** field in the **Alerts & Logging: SMTP & SMS** menu, select **SMS Gateway**. An **SMS via Email Gateway** field will appear.
- Enter the IP address of the outgoing mail **Server** SMS gateway.
- Select a **Secure Connection** (if applicable) and specify the **SMTP port** to be used (if other than the default port 25).
- You may also enter a **Sender** email address which will appear as the “from” address in all email notifications sent from this console server. Some SMS gateway service providers only forward email to SMS when the email has been received from authorized senders. You may need to assign a specific authorized email address for the console server.
- You may also enter a **Username** and **Password**, as some SMS gateway service providers use SMTP servers that require authentication.
- Similarly, you can specify the specific **Subject Line** that will be sent with the email. Generally, the email subject will contain a truncated version of the alert notification message (which is contained in full in the body of the email). Some SMS gateway service providers require blank subjects or require specific authentication headers to be included in the subject line
- Click **Apply Settings** to activate SMS SMTP connection.

7. Alerts, Auto-Response and Logging

SMS via Cellular Modem

To use an attached or internal cellular modem for SMS, the Administrator must enable SMS:

The screenshot shows the 'SMS Settings' configuration interface. It has two main sections. The first section, 'SMS Settings', contains two radio button options: 'SMS Gateway' (which is unselected) and 'Cellular Modem' (which is selected). The second section, 'SMS via Cellular Modem', contains a text input field for 'SMS Message Centre'. Below the input field is a note: 'This is the phone number of the SMS Message Centre (SMSC). Only set this if asked to by support.' At the bottom of the form is an 'Apply Settings' button.

- Select **Cellular Modem** in the **SMS Settings** field.
- Check **Receive Messages** to enable incoming SMS messages to be received. A custom script will be called on receipt of incoming SMS messages.
- You may need to enter the phone number of the carrier's **SMS Message Center** (only if advised by your carrier or tech support).
- Click **Apply Settings** to activate SMS SMTP connection.

Note: The option to directly send SMS alerts via cellular modem was included in the Management GUI in firmware version 3.4. Advanced console servers have had the gateway software (SMS Server Tools 3) embedded since version 3.1. However, this can only be accessed from the command line to send SMS messages.

7.5.3 Send SNMP Trap Alerts

The Administrator can configure the Simple Network Management Protocol (SNMP) agent that resides on the console server to send SNMP trap alerts to an NMS management application:

- Select **Alerts & Logging: SNMP**.

Notes: In firmware versions 3.10.2 and above, new SNMP status and trap MIBs provide more and better-structured SNMP status and traps from console servers. There is an option in the SNMP menu to **Use Legacy Notifications** for the SNMP traps. Selecting this option means the console server will send SNMP traps that are compatible with those sent in older firmware before the new MIBs were added, ensuring that the firmware upgrade will not disrupt existing SNMP management.

When upgrading from old firmware that does not support the newer SNMP MIBs/traps (versions before 3.10.2) to firmware that does support the new MIBs/traps:

- If the SNMP service was enabled and an SNMP manager was configured before upgrading the firmware, the console server will be configured to use the legacy traps after upgrading.
- If the SNMP service was not enabled or SNMP manager was not configured before the upgrade, then the console server will be configured to use the new SNMP traps after the upgrade (this will not have any effect until the SNMP service is turned on and an SNMP manager is configured).
- When starting up in the new firmware after a configuration erase, the console server will be configured to use the new SNMP traps.
- When upgrading from a firmware version that supports the new traps to a newer version that supports the new traps, the use legacy traps setting should remain the same, as no checking on snmp service/manager configuration is needed.
- Select the **Primary SNMP Manager** tab. The Primary and Secondary SNMP Manager tabs configure where and how outgoing SNMP alerts and notifications are sent. If you require your console server to send alerts via SNMP, then a Primary SNMP Manager must be configured (at a minimum). Optionally, a second SNMP Network Manager with its own SNMP settings can be specified on the **Secondary SNMP Manager** tab.

Note: All console servers can also be configured to provide status information on demand using `snmpd`. This SNMP agent is configured using the SNMP Service Detail on Alerts & Logging: SNMP (refer to **15. Advanced Configuration** for more information).

7. Alerts, Auto-Response and Logging



System Name: b093-008-2e4u-v Model: B093-008-2E4U-V Firmware: 4.0.0u1
Uptime: 0 days, 0 hours, 45 mins, 16 secs Current User: root



Alerts & Logging: SNMP

SNMP Service Details | **Primary SNMP Manager** | Secondary SNMP Manager

Manager Protocol
The transport protocol to use to connect to the SNMP Manager.

Manager Address
The address of the SNMP Manager to receive traps.

Manager Trap Port
The TCP/UDP port number to send SNMP traps to.

Version
The SNMP protocol to use for traps.

SNMP v1 & v2c

Community
The SNMP Community to use for traps.

SNMP v3

Engine ID
Override the automatically generated SNMPv3 Engine ID for the trap manager.

Security Level
 No Security
 Authentication
 Authentication and Encryption
The SNMPv3 Security Level. 'Authentication and Encryption' is recommended.

Username
The SNMPv3 user to send traps as.

Auth. Protocol
The SNMPv3 authentication protocol.

Auth. Password
The SNMPv3 users authentication password.

Confirm Password
Confirm the SNMPv3 users authentication password.

- Select the **Manager Protocol**. SNMP is generally a UDP-based protocol, though infrequently it uses TCP instead.
- Enter the host address of the SNMP Network Manager into the **Manager Address** field.
- Enter the TCP/IP port number into the **Manager Trap Port** field (default =162).
- Select the **Version** to be used. The console server SNMP agent supports SNMP v1, v2 and v3.
- Enter the **Community** name for SNMP v1 or SNMP v2c. At a minimum, a community needs to be set for either SNMP v1 or v2c traps to work. An SNMP community is the group to which devices and management stations running SNMP belong. It helps define where information is sent. SNMP default communities are **private** for Write and **public** for Read.
- Configure **SNMP v3** (if required). For SNMP v3 messages, the user's details and security level must match what the receiving SNMP Network Manager is expecting. SNMP v3 mandates that the message will be rejected unless the SNMPv3 user sending the trap already exists in the user database on the SNMP Manager. The user database in a SNMP v3 application is actually referenced by a combination of the Username and the Engine ID for the given SNMP application you are talking to.
 - o Enter the **Engine ID** for the user sending messages as a hex number e.g. 0x8000000001020304.
 - o Specify the **Security Level**. The level of security has to be compatible with the settings of the remote SNMP Network Manager.
 - noAuthNoPriv** No authentication or encryption.
 - authNoPriv** Authentication only. An authentication protocol (SHA or MD5) and password will be required.
 - authPriv** Uses both authentication and encryption. This is the highest level of security and requires an encryption protocol (DES or AES) and password in addition to the authentication protocol and password.

7. Alerts, Auto-Response and Logging

- o Complete the **Username**. This is the Security Name of the SNMPv3 user sending the message. This field is mandatory and must be completed when configuring the console server for SNMPv3.
- o An **Authentication Protocol (SHA or MD5)** and **Authentication Password** must be given for a Security Level of either **authNoPriv** or **authPriv**. The password must contain at least 8 characters to be valid.
- o A **Privacy Protocol (DES or AES)** must be specified for the **authPriv** level of security to be used as the encryption algorithm. AES is recommended for stronger security. A password of at least 8 characters must be provided for encryption to work.
- Click **Apply**.

Note: Console servers with firmware version 3.0 (and later) also embed the net-snmpd daemon which can accept SNMP requests from remote SNMP management servers and provides information on alert / serial / device status (refer to **15.5 SNMP Status Reporting** for more information). Console servers with firmware earlier than V3.3 could only configure a Primary SNMP server from the Management Console. Refer **15.5 SNMP Status Reporting** for details on configuring the snmptrap daemon to send traps/notifications to multiple remote SNMP servers.

7.5.4 Send Nagios Event Alerts

To notify the central Nagios server of Alerts, NSCA must be enabled under **System: Nagios** and Nagios must be enabled for each applicable host or port under **Serial & Network: Network Hosts** or **Serial & Network: Serial Ports** (refer to **10. Nagios Integration**).

7.6 Logging

The console server can maintain log records of auto-response, access and communications events (with the console server and the attached serial, network and power devices).

A log of all system activity is also maintained by default, as is a history of the status of any attached environmental monitors.

7. Alerts, Auto-Response and Logging

7.6.1 Log Storage

Before activating any Event, Serial, Network or UPS logging, you must specify where those logs are to be saved. These records are stored off-server or in the Tripp Lite gateway's USB flash memory.

Select the **Alerts & Logging: Port Log** menu option and specify the **Server Type** to be used, as well as the details to enable log server access.

System Name: b093-008-2e4u-v Model: B093-008-2E4U-V Firmware: 4.0.0u1
Uptime: 0 days, 0 hours, 46 mins, 18 secs Current User: root

Dashboard Manage Devices Backup Log Out

Alerts & Logging: Port Log

Remote Log Storage

Server Type

None
 USB Flash Memory
 Non-volatile internal storage
 Remote Syslog
 NFS
 CIFS (Windows/Samba)

Server Address
The remote Storage Server address.

Server Path
The directory where to store log in.

Username
The login name required for remote server.

Password
The secret required to access the remote server.

Confirm
Re-type the above secret for confirmation.

Syslog Facility
The facility field to include in syslog messages.

Syslog Priority
The priority field to include in syslog messages.

Apply

From the **Manage: Devices** menu, the Administrator can view serial, network and power device logs stored in the console reserve memory (or flash USB). The User will only see logs for the managed devices they (or their group) have been given access privileges for (refer to section **13. Management**).

Event logs on the USB can be viewed using the web terminal or by ssh/telnet connecting to the console server.

7. Alerts, Auto-Response and Logging

7.6.2 Serial Port Logging

In Console Server mode, activity logs can be maintained of all serial port activity. To specify which serial ports are to have activities recorded and to what level data is to be logged:

The screenshot shows the 'Console Server Settings' interface. The 'Logging Level' dropdown menu is open, displaying the following options: 'level 0 - Disabled', 'level 1 - user connects/disconnects to port', 'level 2 - input/output logging on ports + level 1', 'level 3 - input logging on ports + level 1', and 'level 4 - output logging on ports + level 1'. The 'level 0 - Disabled' option is currently selected.

- Select **Serial & Network: Serial Port. Edit** the port to be logged.
- Specify the **Logging Level** of for each port as:
 - Level 0** Turns off logging for the selected port.
 - Level 1** Logs all user connection events to the port.
 - Level 2** Logs all data transferred to and from the port and all changes in hardware flow control status and all user connection events.
 - Level 3** Logs all data transferred from the port and all changes in hardware flow control status and all user connection events.
 - Level 4** Logs all data transferred to the port, all changes in hardware flow control status and all user connection events.
- Click **Apply**

Note: A cache of the most recent 8K of logged data per serial port is maintained locally (in addition to the logs, which are transmitted for remote/USB flash storage). To view the local cache of logged serial port data select **Manage: Port Logs**.

7.6.3 Network TCP and UDP Port Logging

The console server supports optional logging of access to and communications with network-attached hosts.

- For each host, when you set up the permitted services that are authorized to be used, you also must set up the level of logging that is to be maintained for each service.

Serial & Network: Network Hosts

The screenshot shows the 'Edit an Existing Host' configuration page. The 'IP Address/DNS Name' is set to '192.168.254.11'. The 'Description' is 'Mail Server'. Under 'Permitted Services', a list of services is shown: '22/tcp (ssh) - 0', '23/tcp (telnet) - 0', '80/tcp (http) - 0', '443/tcp (https) - 0', '1494/tcp (ica) - 0', '3389/tcp (rdp) - 0', and '5900/tcp (vnc) - 0'. There is a 'Remove' button next to the list. Below the list, 'TCP' is selected with a radio button, and 'UDP' is unselected. A 'Port' field is empty. A dropdown menu for logging level is open, showing 'level 2 - Input/Output logging on services + level 1', 'level 0 - Disabled', 'level 1 - User connects/disconnects to the service', and 'level 2 - Input/Output logging on services + level 1'. The 'level 0 - Disabled' option is currently selected.

7. Alerts, Auto-Response and Logging

- Specify the logging level that is to be maintained for that particular TDC/UDP port/service on that particular host:
 - Level 0** Turns off logging for the selected TDC/UDP port to the selected host.
 - Level 1** Logs all connection events to the port.
 - Level 2** Logs all data transferred to and from the port.
- Click **Add**, then click **Apply**.

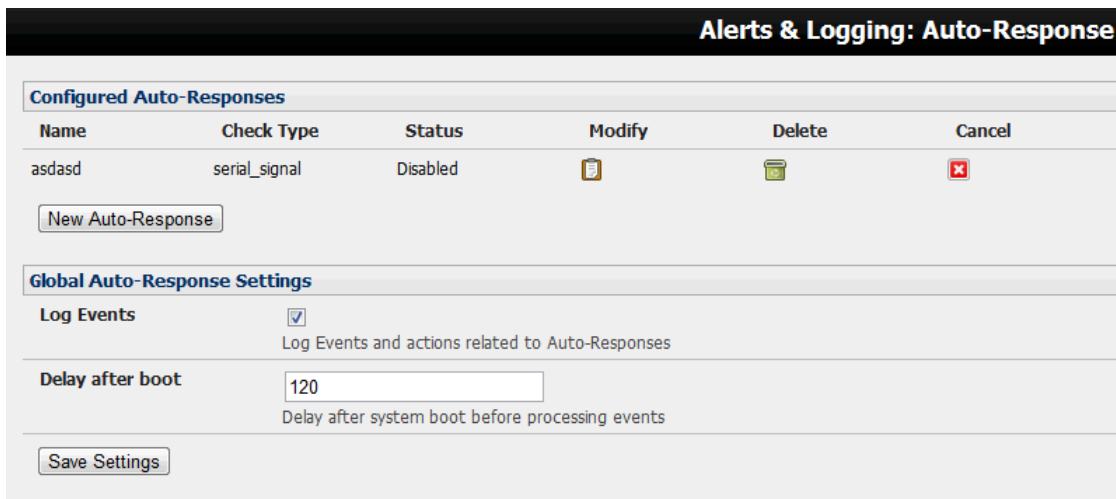

7.6.4 Auto-Response Event Logging

Check **Log Events** on **Alerts & Logging: Auto-Response** to enable logging for all auto-response activities.



Alerts & Logging: Auto-Response

Configured Auto-Responses

Name	Check Type	Status	Modify	Delete	Cancel
asdasd	serial_signal	Disabled			

Global Auto-Response Settings

Log Events
Log Events and actions related to Auto-Responses

Delay after boot
Delay after system boot before processing events

7.6.5 Power Device Logging

The console server also logs access and communications with network-attached hosts and maintains a history of the UPS and PDU power status.

To activate and set the desired levels of logging for each serial, refer to **7.4 Resolve Actions**; for network ports, refer to **7.5 Configure SMTP, SMS, SNMP and/or Nagios Service for Alert Notifications**; and for Power, Environment and Digital I/O UPS, refer to **section 8**.

8. Power, Environment and Digital I/O

Console servers manage Remote Power Control devices (PDUs and IPMI devices) and Uninterruptible Power Supplies (UPS). They also monitor remote operating environments using Environmental Monitoring Devices (EMDs) and sensors and can provide digital I/O control.

8.1 Remote Power Control (RPC)

The console server management console monitors and controls Remote Power Control (RPC) devices using the embedded PowerMan and Network UPS Tools, open source management tools, and Tripp Lite's power management software. RPCs include power distribution units (PDUs) and IPMI power devices.

Serial PDUs can be controlled using their command line console, so you could manage the PDU through the console server using a remote telnet client. Also, you could use proprietary software tools no doubt supplied by the vendor. This generally runs on a remote Windows PC and you could configure the console server serial port to operate with a serial COM port redirector in the PC (refer to section 4. **Serial Port, Host, Device and User Configuration**). Similarly, network-attached PDUs can be controlled with a browser (e.g., with SDT as detailed in section 6.3 **SDT Connector Management Console**), an SNMP management package, or using the vendor-supplied control software. Servers and network-attached devices with embedded IPMI service processors or BMCs are supplied with their own management tools (like SoL) to provide secure management when connected using with SDT Connector.

For simplicity, these devices can be controlled through one window with the Management Console's RPC remote power control tools.

8.1.1 RPC Connection

Serial and network-connected RPCs must first be connected to and configured to communicate with the console server:

- For serial RPCs, connect the PDU to the selected serial port on the console server. From the **Serial and Network: Serial Port** menu, configure the **Common Settings** of that port with the RS-232 properties required by the PDU (refer to 4.1.1 **Common Settings**). Select **RPC** as the **Device Type**.
- Similarly, for each network-connected RPC go to **Serial & Network: Network Hosts** menu and configure the RPC as a connected host by specifying it as **Device Type: RPC** and clicking **Apply** (refer to 4.4 **Network Hosts**).



System Name: b093-008-2e4u-v Model: B093-008-2E4U-V Firmware: 4.0.0u1
Uptime: 0 days, 0 hours, 54 mins, 30 secs Current User: root



Serial & Network: Network Hosts

Manage

- » Devices
- » Port Logs
- » Host Logs
- » Power
- » Terminal

Status

Serial & Network

- » Serial Port
- » Users & Groups
- » Authentication
- » Network Hosts
- » Trusted Networks
- » IPsec VPN
- » OpenVPN
- » PPTP VPN
- » Cascaded Ports
- » UPS Connections
- » RPC Connections
- » Environmental
- » Managed Devices
- » IP Passthrough

Alerts & Logging

- » Port Log
- » Auto-Response
- » SMTP & SMS
- » SNMP

System

- » Administration
- » SSL Certificates
- » Configuration Backup

IP Address/DNS Name
The host's IP Address or DNS name.

Host Name
A descriptive name to identify the host.

Description/Notes
A brief description of the host.

Permitted Services

22/tcp (ssh) - 0
23/tcp (telnet) - 0
80/tcp (http) - 0
443/tcp (https) - 0
1494/tcp (ica) - 0
3389/tcp (rdp) - 0
5900/tcp (vnc) - 0

TCP
 UDP Port

level 2 - Input/Output logging on services + level 1

The TCP services available from this host.

Device Settings

Device Type

Specify the device type.

After applying this setting, use the [RPC Connections page](#) to configure the attached RPC.

8. Power, Environment and Digital I/O

- Select the **Serial & Network: RPC Connections** menu. This will display all RPC connections that have already been configured.
- Click **Add RPC**.
- **Connected Via** presents a list of serial ports and network host connections you have set up with device type RPC (but have yet to connect to a specific RPC device):



The screenshot shows the 'Add RPC' configuration form. The 'Connected Via' dropdown is open, showing three options: 'Network - 192.168.253.240 (PDU-R7D)', 'Network - 192.168.253.240 (PDU-R7D)', and 'Network - 192.168.0.39 (PDU-R5A)'. The first option is selected. The 'RPC Type' dropdown is set to 'None'. The 'Log Connections' dropdown is set to 'level 0 - Disabled'. The 'Name' field is 'PDU-R7D' and the 'Description' field is 'Baytech PDU'. The 'Username' field is empty.

Add RPC	
Connected Via	Network - 192.168.253.240 (PDU-R7D)
RPC Type	None
Log Connections	level 0 - Disabled
Name	PDU-R7D
Description	Baytech PDU
Username	

- o When you select **Connect Via** for a Network RPC connection, the corresponding host name/description you set for that connection will be entered as the **Name** and **Description** for the power device.
- o Alternately, if you select to **Connect Via** a serial connection, you will need to enter a **Name** and **Description** for the power device.

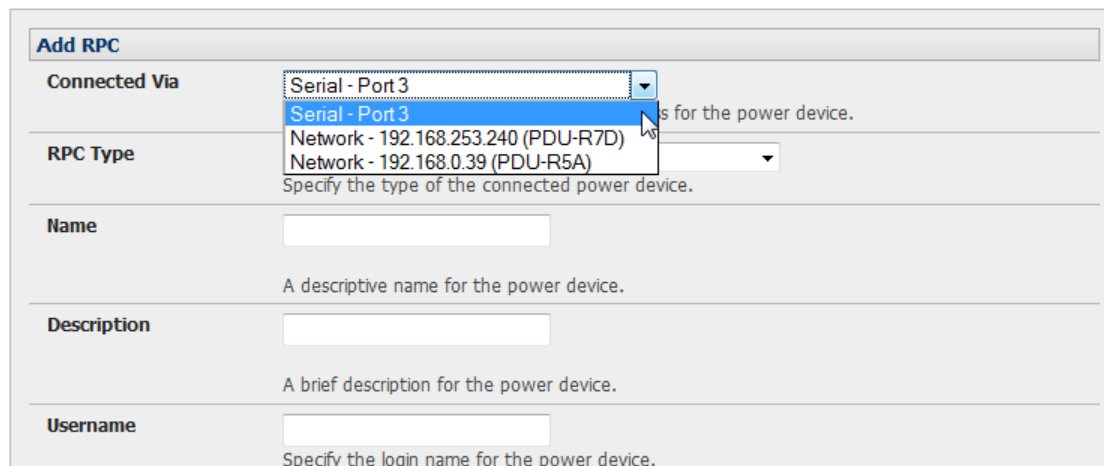

The screenshot shows the 'Add RPC' configuration form. The 'Connected Via' dropdown is open, showing three options: 'Serial - Port 3', 'Serial - Port 3', and 'Network - 192.168.253.240 (PDU-R7D)'. The first option is selected. The 'RPC Type' dropdown is set to 'None'. The 'Log Connections' dropdown is set to 'level 0 - Disabled'. The 'Name' field is empty and the 'Description' field is empty. The 'Username' field is empty.

Add RPC	
Connected Via	Serial - Port 3
RPC Type	None
Log Connections	level 0 - Disabled
Name	
Description	
Username	

8. Power, Environment and Digital I/O

- Select the appropriate **RPC Type** for the PDU (or IPMI) being connected:
 - o If you are connecting to the RPC via the network, you will be presented with the IPMI protocol options and the SNMP RPC Types currently supported by the embedded Network UPS Tools.

Serial & Network: RPC Connections

Add RPC

Name
A descriptive name for the power device.

Description
A brief description for the power device.

Connected Via Network - 192.168.0.54 (PDU-R3C) ▾
Specify the serial port or network host address for the power device.

RPC Type ▾

Log Connections IPMI 1.5 (1 outlets)
IPMI 2.0 (1 outlets)
SNMP Controlled Baytech (Variable outlets)
SNMP Controlled Eaton/Aphel Revelation (Variable outlets)
SNMP Controlled Leviton (Variable outlets)
SNMP Controlled Metered PDU (8 outlets)
SNMP Controlled Servertech (Variable outlets)
SNMP Controlled Tripplite (Variable outlets)

Username

Password

- o If you are connecting to the RPC by a serial port, you will be presented with all the serial RPC types currently supported by the embedded PowerMan and Tripp Lite's power manager:

Serial & Network

- » Serial Port
- » Users & Groups
- » Authentication
- » Network Hosts
- » Trusted Networks
- » Cascaded Ports
- » UPS Connections
- » RPC Connections
- » Environmental
- » Managed Devices

Alerts & Logging

- » Port Log

Add RPC

Name

Description

Connected Via

RPC Type ▾

Specify the type of the connected power device.

- IBM Blade Center (15 outlets)
- IBM H8 (1 outlets)
- ICS 8064 (16 outlets)
- IP Power 9258 via RS232 (4 outlets)
- Linux Network ICE Box v2.x (10 outlets)
- Linux Network ICE Box v3.x, v4.x (10 outlets)
- Measurement Computing Corp. CB-7050 (8 outlets)
- MicroEnergetics APC S6 (6 outlets)
- Phantom v3, v4 (1 outlets)
- Rose UltraPower (12 outlets)
- Server Technology Sentry Switched CDU (8 outlets)
- Sun Integrated Lights Out Management (1 outlets)
- WTI NetPowerSeries (8 outlets)

- Enter the **Username** and **Password** used to log in to the RPC.

Note: These login credentials are not related. The users and access privileges you will have configured in **Serial & Networks: Users & Groups**.

8. Power, Environment and Digital I/O

- If you selected SNMP protocol, you will need to enter the SNMP v1 or v2c Community for Read/Write access (by default this is set to “private”).

Edit RPC

Name	PDU-R4A A descriptive name for the power device.
Description	<input type="text" value="PDU Rack 4A"/> A brief description for the power device.
Connected Via	Network - 192.168.252.31 (PDU-R4A) Specify the serial port or network host address for the power device.
RPC Type	SNMP Controlled Baytech Specify the type of the connected power device.
Username	<input type="text"/> Specify the login name for the power device.
Password	<input type="password"/> Specify the login secret for the power device.
Confirm	<input type="password"/> Confirm the login secret for the power device.
SNMP Community	<input type="text" value="private"/> SNMP v1 or v2c Community for Read/Write access.
Log Status	<input checked="" type="checkbox"/> Periodically log RPC status.
Log Rate	<input type="text" value="1"/> Minutes between samples.

- Check **Log Status** and specify the **Log Rate** (minutes between samples) if you wish the status from this RPC to be logged. These logs can be viewed from the **Status: RPC Status** screen.
- Click **Apply**.
- For SNMP PDUs, the console server will now probe the configured RPC to confirm the RPC Type matches and will report the number of outlets it finds that can be controlled. If unsuccessful, it will report **Unable to probe outlets** and you will need to check the RPC settings or network/serial connection.

Serial & Network: RPC Connections

Probing RPC

Probed 8 outlets

[Return to RPC Connections](#)

- For serially connected RPC devices, a new managed device with the same name as given to the RPC will be created. The console server will then configure the RPC with the number of outlets specified in the selected RPC Type or will query the RPC itself for this information.

Note: Tripp Lite’s console servers support most network and serial PDUs. If your PDU is not on the default list, support can be added directly (refer to **14. Configuration from the Command Line**) or by having the PDU support added to either the Network UPS Tools or PowerMan open source projects.

IPMI service processors and BMCs can be configured so all authorized users can use the management console to remotely cycle power and reboot computers, even when their operating system is unresponsive. To set up IPMI power control, the Administrator will first enter the IP address/domain name of the BMC or service processor (e.g. a Dell DRAC) in **Serial & Network: Network Hosts**, then in **Serial & Network: RPC Connections**. The **RPC Type** should be IPMI1.5 or 2.0.

8. Power, Environment and Digital I/O

8.1.2 RPC Access, Privileges and Alerts





You can set PDU and IPMI alerts using **Alerts & Logging: Alerts** (refer to **7. Alerts, Auto-Response and Logging**). You can also assign which user can access and control a particular outlet on each RPC using **Serial & Network: User & Groups** (refer to **4. Serial Port, Host, Device and User Configuration**).

8.1.3 User Power Management

The power manager enables both users and administrators to access and control the configured serial and network attached PDU power strips, servers with embedded IPMI service processors or BMCs:





Manage: Power

Target 192.168.253.240 (SNMP Controlled Baytech) Outlet Outlet 2 (2)
Select a power device to manage.

Action  Turn On  Turn Off  Cycle  Status
Perform an action on the power device.

Status on





- Select **Manage: Power**, the particular Target power device to be controlled and the outlet to be controlled (if the RPC supports outlet level control).
- The outlet status is displayed. You can initiate the desired Action to be taken by selecting the appropriate icon:

-  **Turn ON**
-  **Turn OFF**
-  **Cycle**
-  **Status**

You will only be presented with icons for those operations that are supported by the **Target** you have selected.

Manage: Power

Target Port 1 (Baytech RPC3ADE) Outlet 1 (1)
Select a power device to manage.

Action  Turn On  Turn Off  Cycle  Status
Perform an action on the power device.

Outlets

Outlet Group	True RMS Current	Peak RMS Current	True RMS Voltage	Average Power	Volt-Amps
Outlet 1-8	0.1 Amps	0.2 Amps	242.0 Volts	34 Watts	44 VA

Internal Temperature: 92.3 F
Switch 1: Open 2: Open
1)...Outlet 1 : On
2)...Outlet 2 : On
3)...Outlet 3 : On
4)...Outlet 4 : On
5)...Outlet 5 : On
6)...Outlet 6 : On
7)...Outlet 7 : On
8)...Outlet 8 : On

8. Power, Environment and Digital I/O

8.1.4 RPC Status

You can monitor the current status of your network and serially connected PDUs and IPMI RPCs.

- Select the **Status: RPC Status** menu. A table with the summary status of all connected RPC hardware will display.

Status: RPC Status

RPC StatusRPC Logs

RPC Status

Name	Description	RPC Type	Connected Via	Outlet Status		
IPPower	IP Power 9825	IP Power 9258 via RS232	Serial - Port 1	N/A *	View Log	Manage
SR#3PDU	Power to rack SR 3	Server Technology Sentry Switched CDU	Network - 192.168.26.2 <i>(SR#3 PDU)</i>	N/A *		Manage
DRAC	VMWare Accounts	IPMI 2.0	Network - 192.168.26.45 <i>(Dell DRAC)</i>	N/A *		Manage

* Status unavailable or not supported by this summary, click *Manage* to query individual outlet status.

- Click on **View Log** or select the **RPCLogs** menu. You will be presented with a table of the history and detailed graphical information on the selected RPC.

Status: RPC Status

RPC StatusRPC Logs

PDU-R7D (Power Rack 7 Row D) - Sensor Graphs

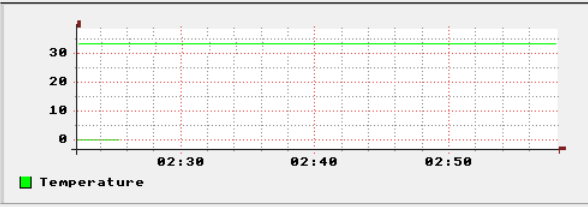

■ Temperature

PDU-R7D (Power Rack 7 Row D) - Log

Time	Temperature	Alert Status
Wed Mar 25 02:22:11 2009	33	Normal
Wed Mar 25 02:22:22 2009	33	Normal
Wed Mar 25 02:23:00 2009	33	Normal
Wed Mar 25 02:24:01 2009	33	Normal

- Click **Manage** to query or control the individual power outlet. This will take you to the **Manage: Power** screen.

8. Power, Environment and Digital I/O

8.2 Uninterruptible Power Supply (UPS) Control

All Tripp Lite console servers can be configured to manage locally and remotely connected UPS hardware using Network UPS Tools.

Network UPS Tools (NUT) is a group of open source programs that provide a common interface for monitoring and administering UPS hardware to ensure safe shutdowns of connected systems. NUT is built on a networked model with a layered scheme of drivers, server and clients (refer to **8.2.6 Overview of Network UPS Tools**).

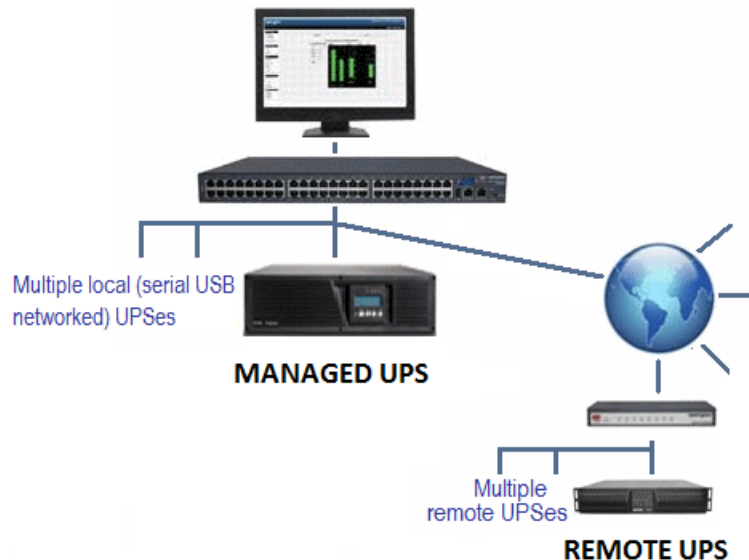

8.2.1 Managed UPS Connections

A managed UPS directly connects as a managed device to the console server. It can be connected by serial cable, USB cable, or the network. The console server becomes the Primary unit of this UPS and runs a upsd server to allow other computers that are drawing power through the UPS (Secondary units) to monitor the UPS status and take appropriate action, such as shutdown in event of low UPS battery.

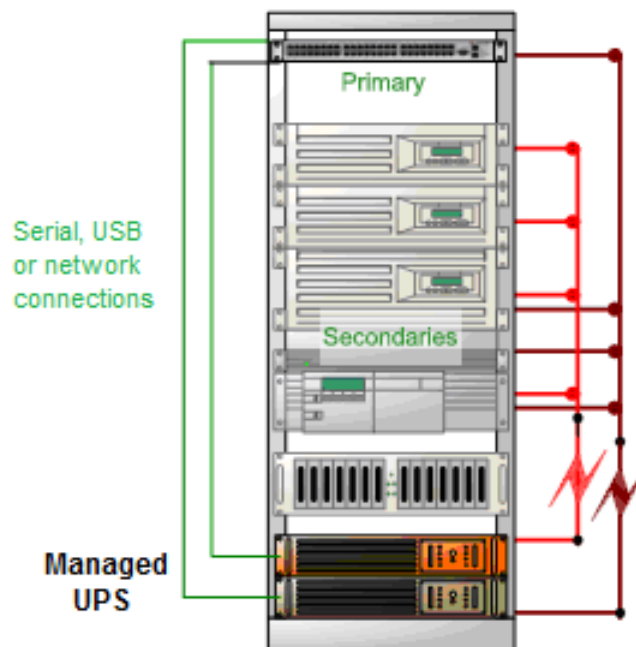

The console server may or may not be drawing power through the managed UPS. When the UPS battery power reaches a critical point, the console server will signal and wait for Secondary units to shut down before powering off the UPS.

8. Power, Environment and Digital I/O

Serial and network-connected UPS systems must first be connected to and configured to communicate with the console server:

- For serial UPS systems, attach the UPS to the selected serial port on the console server. From the **Serial and Network: Serial Port** menu, configure the Common Settings of that port with the RS-232 properties required by the UPS (refer to **4.1.1 Common Settings**). Select **UPS** as the **Device Type**.
- Similarly, for each network-connected UPS, go to **Serial & Network: Network Hosts** menu and configure the UPS as a connected host by specifying it as **Device Type: UPS**. Click **Apply**.

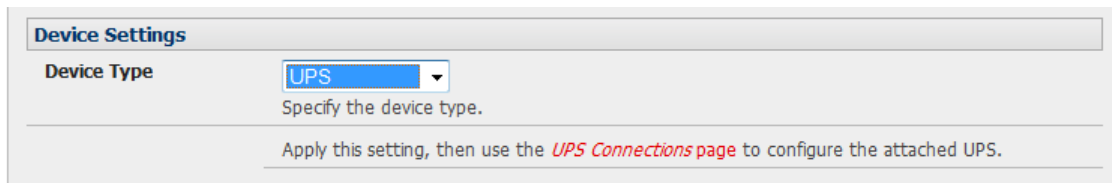

The screenshot shows a 'Device Settings' form. The 'Device Type' dropdown menu is set to 'UPS'. Below the dropdown, there is a text input field and a note: 'Specify the device type.' At the bottom of the form, there is a note: 'Apply this setting, then use the [UPS Connections](#) page to configure the attached UPS.'

- No such configuration is required for USB-connected UPS hardware.
- Select the **Serial & Network: UPS Connections** menu. The **Managed UPS** section will display all UPS connections that have already been configured.
- Click **Add Managed UPS**.

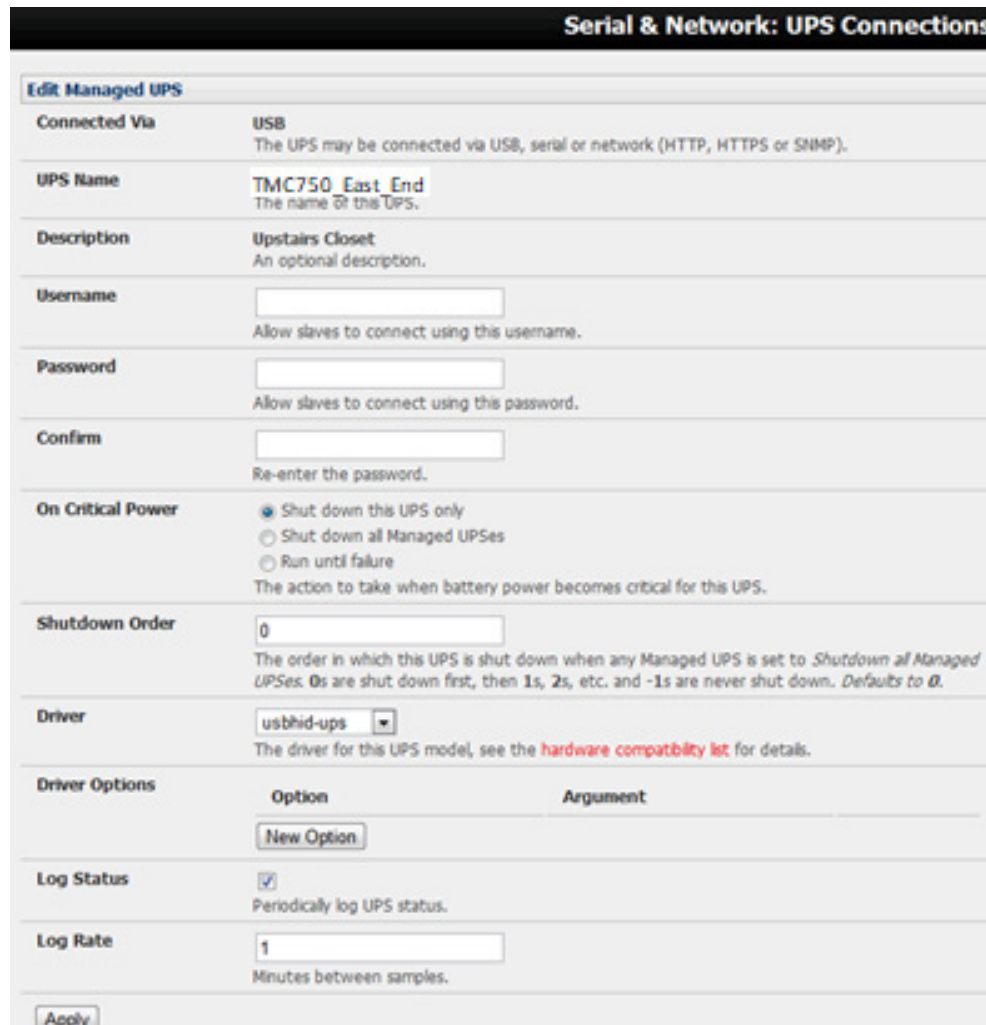

The screenshot shows the 'Serial & Network: UPS Connections' form. The form is titled 'Edit Managed UPS'. It contains the following fields and options:

- Connected Via:** USB. The UPS may be connected via USB, serial or network (HTTP, HTTPS or SNMP).
- UPS Name:** TMC750 East End. The name of this UPS.
- Description:** Upstairs Closet. An optional description.
- Username:** [Text input field]. Allow slaves to connect using this username.
- Password:** [Text input field]. Allow slaves to connect using this password.
- Confirm:** [Text input field]. Re-enter the password.
- On Critical Power:** Shut down this UPS only, Shut down all Managed UPSes, Run until failure. The action to take when battery power becomes critical for this UPS.
- Shutdown Order:** 0. The order in which this UPS is shut down when any Managed UPS is set to *Shutdown all Managed UPSes*. 0s are shut down first, then 1s, 2s, etc. and -1s are never shut down. Defaults to 0.
- Driver:** usbid-ups. The driver for this UPS model, see the [hardware compatibility list](#) for details.
- Driver Options:** A table with columns 'Option' and 'Argument'. A 'New Option' button is present.
- Log Status:** . Periodically log UPS status.
- Log Rate:** 1. Minutes between samples.

An 'Apply' button is located at the bottom of the form.

- Select if the UPS will be **Connected Via USB**, over preconfigured serial port or SNMP/HTTP/HTTPS over the preconfigured network host connection.

8. Power, Environment and Digital I/O

- When you select a network UPS connection, the corresponding host name/description you set up for that connection will be entered as the **Name** and **Description** for the power device. Alternately, if you selected to **Connect Via** USB or serial connection, you will need to enter a **Name** and **Description** for the power device (these details will also be used to create a new managed device entry for the serial/USB-connected UPS devices).
- Enter the login details. This **Username** and **Password** is used by Secondary units of this UPS (i.e. other computers that are drawing power through this UPS) to connect to the console server to monitor the UPS status so they can shut themselves down when battery power is low. Monitoring will typically be performed using the **upsmon** client running on the Secondary server (refer to **8.2.3 Controlling UPS Powered Computers**).

Note: These login credentials are not related to the users and access privileges configured in *Serial & Networks: Users & Groups*.

- Select the action to take when UPS battery power becomes critical (i.e. shut down the UPS or shut down all managed UPS systems) or simply allow the unit(s) to run until failure.

Note: The shutdown script `/etc/scripts/ups-shutdown` can be customized in the event of a critical power failure (when the UPS battery runs out). In doing so, you can program the console server to perform final shutdown actions before backup power is lost. However, it is easier to perform final shutdown actions by triggering auto-response on the UPS. Refer to **7. Alerts, Auto-Response and Logging** for more information.

- If you have multiple UPS systems and require them to be shut down in a specific order, specify the **Shutdown Order** for this UPS. This is a whole positive number, or -1. 0s are shut down first, then 1s, 2s, etc. -1s are not shut down at all. The default setting is 0.
- Select the **Driver** that will be used to communicate with the UPS.

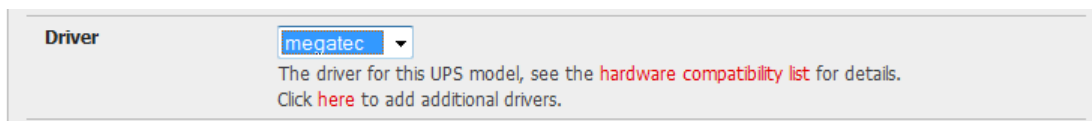

- Click **New Options** in **Driver Options** if you need to set driver-specific options for your selected NUT driver and hardware combination (more details can be found at <http://www.networkupstools.org/doc>).

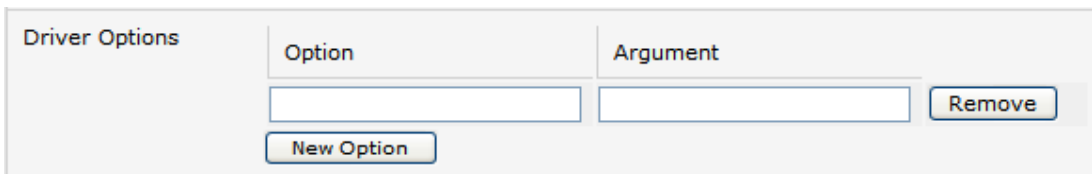

- Check **Log Status** and specify the **Log Rate** (minutes between samples) if you wish to have the status from this UPS be logged. These logs can then be viewed from the **Status: UPS Status** screen.
- If Nagios services are enabled, you will be presented with an option for Nagios monitoring. Check the **Enable Nagios** checkbox to allow the UPS to be monitored using Nagios central management.

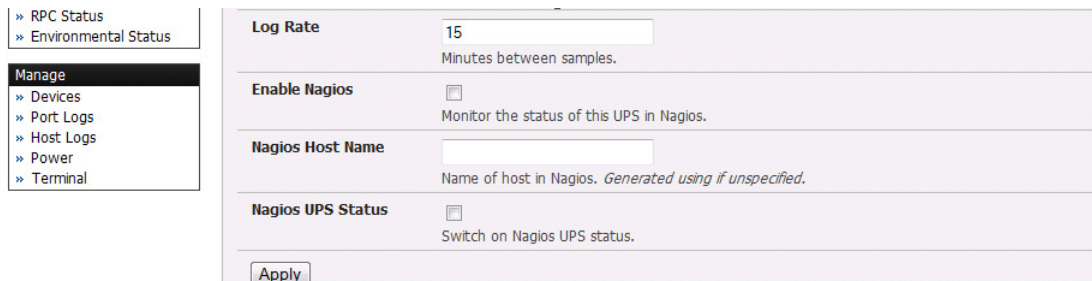

- Check **Enable Shutdown Script** if the UPS is providing power to the console server. In the event of a critical power failure, you can perform any final shutdown actions on the console server before power is lost. This is done by placing a custom script in `/etc/config/scripts/ups-shutdown` (you may use the provided `/etc/scripts/ups-shutdown` as a template). This script is only run when the UPS reaches critical battery status.
- Click **Apply**.

Note: You can also customize the `upsmon`, `upsd` and `upsc` settings for this UPS hardware directly from the command line.

8. Power, Environment and Digital I/O

8.2.2 Remote UPS Management

A remote UPS is a managed device connected to a remote console server that is being monitored (but not managed) by your console server.

The upsc and upslog clients in the Tripp Lite console server can be configured to monitor remote servers running Network UPS Tools that manage their locally connected UPS systems. These remote servers may be other Tripp Lite console servers or generic Linux servers running NUT. All distributed UPS systems may be spread in a row in a data center, around a campus property or across the country, and can be centrally monitored through a single central console server window. To add a remote UPS:

Serial & Network: UPS Connections

Managed UPSes							
UPS Name	Description	Driver	Username	Shutdown Order	Connected Via		
tripplite	Smart UPS	tripplite	xx	0	Serial - Port #4 (Port 4)	Edit	Delete

[Add Managed UPS](#)

Remote UPSes			
UPS Name	Description	Address	
tripplite	SD4002 - SUINT1000RTXL2U	192.168.254.145	Edit Delete

[Add Remote UPS](#)

- Select the **Serial & Network: UPS Connections** menu. The **Remote UPS** section will display all the remote UPS devices being monitored.
- Click **Add Remote UPS**.



System Name: b093-008-2e4u-v Model: B093-008-2E4U-V Firmware: 4.0.0u1
Uptime: 1 days, 1 hours, 5 mins, 29 secs Current User: root



Serial & Network: UPS Connections

Manage

- » Devices
- » Port Logs
- » Host Logs
- » Power
- » Terminal

Status

- » Port Access
- » Active Users
- » Statistics
- » Support Report
- » Syslog
- » UPS Status
- » RPC Status
- » LLDP/CDP Neighbors
- » Environmental Status
- » Dashboard

Serial & Network

Add Remote UPS

UPS Name
The name of this UPS.

Description
An optional description.

Address
The address or DNS name of the host managing this UPS.

Log Status
Periodically log UPS status.

Log Rate
Minutes between samples.

[Apply](#)

- Enter the **Name** of the particular remote UPS to be remotely monitored. This name must be the name that the remote UPS was configured to on the remote console server (as the remote console server may have multiple UPS units that it is managing locally with NUT). Optionally, you may also enter a **Description**.

8. Power, Environment and Digital I/O

- Enter the **IP Address** or DNS name of the remote console server* that is managing the remote UPS. (*This may be another Tripp Lite console server or it may be a generic Linux server running Network UPS Tools).

Note: An example where centrally monitored and remotely distributed UPS systems are useful is a campus or large business site where a multitude of computer and other equipment sites are widely spread out and with each containing its own UPS supply. Many of these sites (particularly the smaller sites) will be USB or serially connected.

Having a console server at these remote sites allows the system manager to centrally monitor the power supply status at all sites and centralize alarms. In doing so, the system manager can receive warning to initiate a call-out or shut down.

- Check **Log Status** and specify the **Log Rate** (minutes between samples) if you wish the status from the UPS to be logged. These logs can then be viewed from the **Status: UPS Status** screen.
- Check **Enable Shutdown Script** if the remote UPS is providing power to the console server. In the event the UPS reaches critical battery status, the custom script in **/etc/config/scripts/ups-shutdown** will run, allowing you to perform any final shutdown actions.
- Click **Apply**.

Note: The remote UPS feature is supported on all console servers with firmware version 2.8 and later. Earlier versions support a single remote "Monitored UPS", which could be set to trigger the console server shutdown script.

8.2.3 Controlling UPS Powered Computers

One advantage of using a managed UPS is you can configure computers that draw power through that UPS to be shut down gracefully in the event of a prolonged power failure.

For Linux computers, this is accomplished by setting up upsmon on each computer and directing them to monitor the console server managing their UPS. This will set the specific conditions used to initiate a computer shut down. Non-critical servers may be powered down seconds after the UPS starts running on battery, whereas servers that are more critical may not shut down until a low battery warning is received. Refer to the online NUT documentation for details:

<http://eu1.networkupstools.org/doc/2.2.0/INSTALL.html>

<http://linux.die.net/man/5/upsmon.conf>

<http://linux.die.net/man/8/upsmon>

An example upsmon.conf entry may look like:

```
MONITOR managedups@192.168.0.1 1 username password Secondary
```

- managedups is the UPS Name of the Managed UPS
- 192.168.0.1 is the IP address of the Tripp Lite console server
- 1 indicates the server has a single power supply attached to this UPS
- username is the Username of the Managed UPS
- password is the Password of the Manager UPS

NUT monitoring clients are available for Windows computers (WinNUT).

If you have an RPC (PDU), it is also possible to shut down UPS-powered computers and other equipment without them having a client running (e.g., communications and surveillance gear).

8.2.4 UPS Alerts

You can set UPS alerts using **Alerts & Logging: Alerts** (refer to **7. Alerts, Auto-Response and Logging**).

8. Power, Environment and Digital I/O

8.2.5 UPS Status

You can monitor the current status of your network, serial or USB-connected managed UPS systems and any configured remote UPS systems.

- Select the **Status: UPS Status** menu. A table with the summary status of all connected UPS hardware will display.

Status: UPS Status

Summary		blazer	tripplite@sd4002						
Thu May 14 02:23:18 EDT 2009									
System	Model	Status	Battery	Input (VAC)	Output (VAC)	Load (%)	UPS Temp	Battery Runtime	Data Tree
blazer	[error: Data stale]	[error: Data stale]							All data
tripplite	SUIINT1000RTL2Ua	ONLINE	100 %	240.2	230.6	0 %			All data

- Click on any **UPS System** name in the table and you will be presented with detailed graphical information.

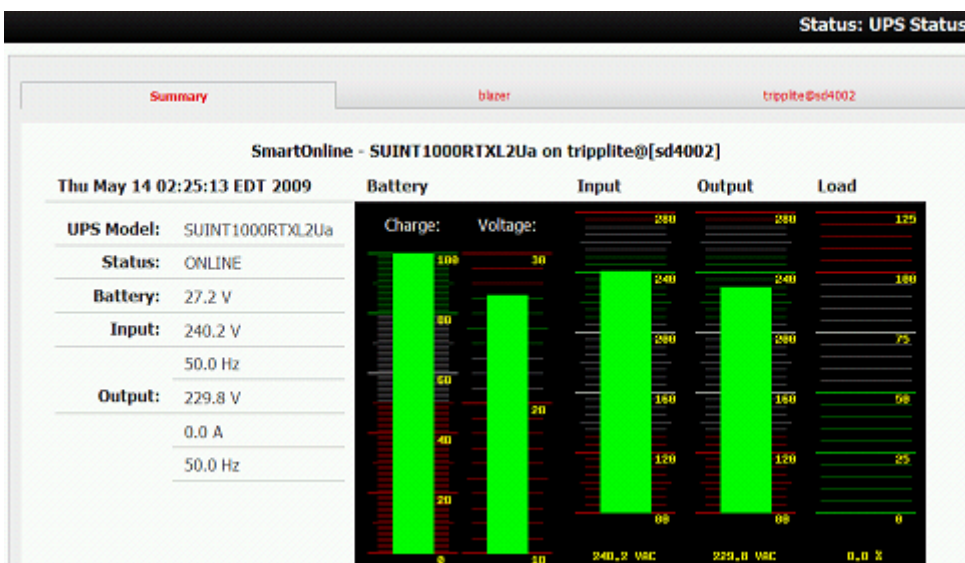

- Click on **All Data** for any UPS System in the table for more status and configuration information of a UPS System.

```

Dev UPS
battery.voltage      : 13.5
driver.name          : bcmxcp_usb
driver.parameter.pollinterval : 2
driver.parameter.port : auto
driver.parameter.shutdown_delay : 60
driver.version       : 2.2.2
driver.version.internal : 0.14
input.frequency      : 49.9
input.voltage        : 244
output.current       : 0.1
output.frequency     : 49.9
output.phases        : 1
output.voltage       : 244
output.voltage.nominal : 240
ups.firmware         : Cont:00.50 Inve:01.50
ups.load             : 7.7
ups.model            : POWERWARE UPS 500VA
ups.power.nominal    : 500
ups.serial           :
ups.status           : OL
    
```

8. Power, Environment and Digital I/O

- By selecting **UPS Logs**, you will be presented with the log table of the load, battery charge level, temperature and other status information from all managed and monitored UPS systems. This information is logged for all UPS systems configured with the **Log Status** box checked. The information is also presented graphically.

8.2.6 Overview of Network UPS Tools (NUT)

NUT is built on a networked model with a layered scheme of drivers, server and clients. NUT can be configured using the management console as described above, or you can configure the tools and manage the UPS systems directly from the command line. This section provides an overview of NUT. Full documentation is available at <http://www.networkupstools.org/doc>.

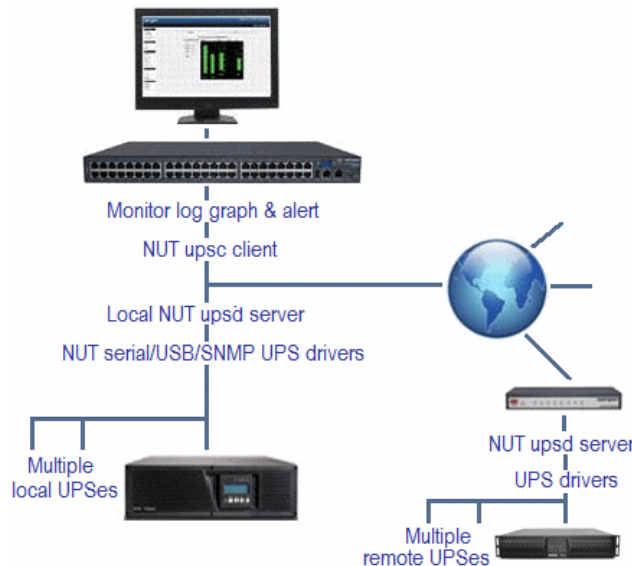

NUT is built on a networked model with a layered scheme of drivers, server and clients:

- The **driver** programs communicate directly to the UPS equipment and run on the same host as the NUT network server (`upsd`). Drivers are provided for a wide assortment of equipment from most of the popular UPS vendors. They understand the specific language of each UPS. They communicate to serial, USB and SNMP network-connected UPS hardware and map the communications back to a compatibility layer. As a result, both a “smart” protocol UPS and a simple “power strip” model can be handled transparently.
- The NUT network **server** program `upsd` is responsible for passing status data from the drivers to the client programs via the network. `upsd` can cache the status from multiple UPS systems and then serve this status data to many clients. `upsd` also contains access control features to limit the abilities of the clients, so only authorized hosts may monitor or control the UPS hardware.
- There are a number of NUT **clients** that connect to `upsd` to check on the status of the UPS hardware and perform actions based on the status. These clients can run on the same host as the NUT server or they can communicate with the NUT server over the network, enabling them to monitor any UPS anywhere:
 - The **upsc** client provides a quick way to poll the status of a UPS server. It can be used inside shell scripts and other programs that require UPS data but do not want to include the full interface.
 - The **upsmon** client enables servers that draw power through the UPS to shutdown gracefully when the battery power reaches a critical low point.
 - Logging clients (**upslog**) and third party interface clients (Big Sister, Cacti, Nagios, Windows and more) are also available.
- The latest release of NUT (2.4) also controls PDU systems, either natively using SNMP or through a binding to Powerman (open source software from Livermore Labs is embedded in Tripp Lite console servers).

8. Power, Environment and Digital I/O

NUT clients and servers all are embedded in each Tripp Lite console server, with a management console presentation layer added. They also run remotely on distributed console servers and other remote NUT monitoring systems. Layered distributed NUT architecture enables:

- **Multiple manufacturer support:** NUT can monitor UPS models from 79 different manufacturers - and PDUs from a growing number of vendors - with a unified interface.
- **Multiple architecture support:** NUT can manage serial and USB-connected UPS models with the same common interface. Network-connected USB and PDU equipment can also be monitored using SNMP.
- **Multiple clients monitoring one UPS:** Multiple systems may monitor a single UPS using only their network connections. A wide selection of client programs is available to support monitoring UPS hardware via NUT (Big Sister, Cacti, Nagios and more).
- **Central management of multiple NUT servers:** A central NUT client can monitor multiple NUT servers that may be distributed throughout the data center, across a campus or around the world.

NUT supports complex power architectures found in data centers, communications centers and distributed office environments where UPS systems from various vendors power systems and clients of all sizes and types.

8.3 Environmental Monitoring

The B090-EMD Environmental Monitoring Device (EMD) can be connected to any Console Server serial port and each Console Server can support multiple EMDs. Each EMD has one temperature sensor, one humidity sensor and one general-purpose status sensor that can be connected to a smoke detector, water detector, vibration or open-door sensor.

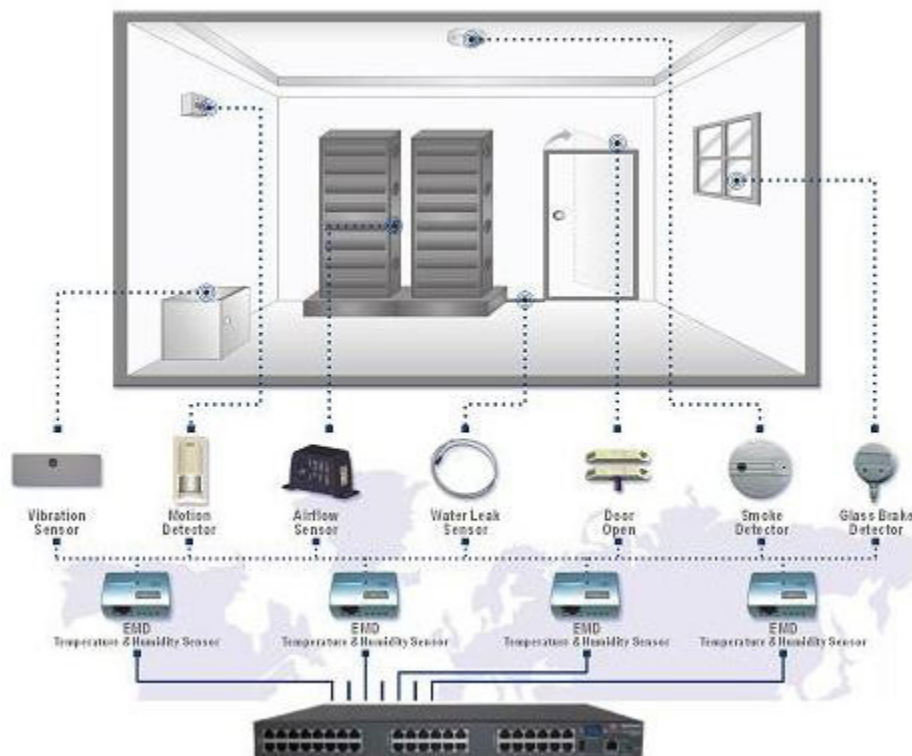

8. Power, Environment and Digital I/O

8.3.1 Connecting the EMD and its Sensors

The Environmental Monitor Device (EMD) connects to any serial port on the console server via special EMD Adapter and standard Cat5 cable. The sensors screw into the EMD.



EMD

The EMD is powered over the serial port connection and communicates using a custom handshake protocol. It is not an RS-232 device and should not be connected without the adapter.



EMD Adapter

Plug the EMD adapter's male RJ connector (model B090-EMD-ADP) into the EMD. Then connect the adapter to the console server serial port using the provided UTP cable. If the 6 ft. (2 m) UTP cable provided with the EMD is not long enough, it can be replaced with a standard Cat5 UTP cable up to 33 ft. (10 m) in length (Tripp Lite N002-Series cables).



EMD sensor

Screw the bare wires on any smoke detector, water detector, vibration sensor, open-door sensor or general purpose open/close status sensors into the terminals on the EMD.

Screw the bare wires on any smoke detector, water detector, vibration sensor, open-door sensor or general purpose open/close status sensors into the terminals on the EMD.

B090-WLS – Console Server Water Leak Sensor

B090-DCS – Console Server Door Contact Sensor

B090-VS – Console Server Vibration Sensor

B090-SD-110 – Console Server Smoke Detector – 110V

B090-SD-220 – Console Server Smoke Detector – 120V

Note: Console servers only support attaching a single sensor to each EMD.

The EMD can only be used with a console server and cannot be connected to standard RS-232 serial ports on other devices.

- Select **Environmental** as the **Device Type** in the **Serial & Network: Serial Port** menu for the port to which the EMD is to be attached. No particular common settings are required.
- Click **Apply**.

Device Settings

Device Type Specify the device type.

Apply this setting, then use the [Environmental](#) page to configure the attached environmental monitor.

8. Power, Environment and Digital I/O

- When configured as Inputs, the SENSOR and DIO ports are notionally attached to the internal EMD. Go to the **Serial & Network: Environmental** page and enable the **Internal EMD**. Then configure the attached sensors as alarms, as covered in the next section.



System Name: b093-008-2e4u-v Model: B093-008-2E4U-V Firmware: 4.0.0u1
Uptime: 1 days, 1 hours, 23 mins, 13 secs Current User: root

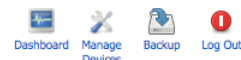

Serial & Network: Environmental

Manage

- » Devices
- » Port Logs
- » Host Logs
- » Power
- » Terminal

Status

- » Port Access
- » Active Users
- » Statistics
- » Support Report
- » Syslog
- » UPS Status
- » RPC Status
- » LLDP/CDP Neighbors
- » Environmental Status
- » Dashboard

Serial & Network

- » Serial Port
- » Users & Groups
- » Authentication
- » Network Hosts
- » Trusted Networks
- » IPsec VPN
- » OpenVPN
- » PPTP VPN
- » Cascaded Ports
- » UPS Connections
- » RPC Connections
- » Environmental
- » Managed Devices
- » IP Passthrough

Alerts & Logging

- » Port Log
- » Auto-Response

Enabled Enable or disable the environmental monitor.

Edit Environmental Monitor

Name Internal environmental sensor
A descriptive name for the environmental monitor.

Connected Via Internal
Specify the connection port for the environmental monitor.

Description
A brief description for the environmental monitor.

Temperature Offset
Fine tuning adjustment for the temperature sensor.

DI 1 Label
A label for this Digital I/O, e.g. *Door Open* or *Smoke Alarm*.
Digital I/O 1 must be configured as an 'Input' for this alarm to function correctly.
This is done on the [Digital I/O page](#)

DI 2 Label
A label for this Digital I/O, e.g. *Door Open* or *Smoke Alarm*.
Digital I/O 2 must be configured as an 'Input' for this alarm to function correctly.
This is done on the [Digital I/O page](#)

Log Status Periodically log environmental status.

Log Rate
Minutes between samples.

8.3.2 Adding EMDs and Configuring the Sensors

- Select the **Serial & Network: Environmental** menu. This will display any external EMDs or any “internal EMD” (i.e. sensors that may be directly attached to the unit) that have already been configured.

Serial & Network: Environmental

Environmental Monitors

Name	Description	Connected Via	Log Status	Enabled
No environmental monitors have been configured.				
<input type="button" value="Add"/>				

- To add a new EMD, click Add and configure an external EMD. Enter a **Name** and (optionally) a **Description**. Select the preconfigured serial port the EMD will be **Connected Via**.

8. Power, Environment and Digital I/O

Serial & Network: Environmental

Add Environmental Monitor
Name
A descriptive name for the environmental monitor.
Connected Via
Specify the connection port for the environmental monitor.
Description
A brief description for the environmental monitor.
Temperature Offset
Fine tuning adjustment for the temperature sensor.
Humidity Offset
Fine tuning adjustment for the humidity sensor.
Temperature in Fahrenheit
Indicates if the temperature is reported in Fahrenheit rather than Celcius.
Alarm #1 Label
A label for this alarm sensor, e.g. *Door Open* or *Smoke Alarm*.
Alarm #2 Label
A label for this alarm sensor, e.g. *Door Open* or *Smoke Alarm*.
Log Status
Periodically log environmental status.
Log Rate
Minutes between samples.

- You may optionally calibrate the EMD with a Temperature Offset (+ or - °C) or Humidity Offset (+ or percent). If you check **Temperature in Fahrenheit**, the temperature will be reported in Fahrenheit. Otherwise, it will be reported in degrees Celsius.
- Provide **Labels** for each of the alarm sensors that will be used (e.g., door open or smoke alarm).
- Check **Log Status** and specify the **Log Rate** (minutes between samples) if you wish the status from this EMD to be logged. These logs can be views from the **Status: Environmental Status** screen.
- Click **Apply**. This will also create a new managed device with the same name.

8.3.3 Environmental Alerts

Set temperature, humidity and probe status alerts using **Alerts & Logging: Alerts** (refer to **7. Alerts, Auto-Response and Logging** for more information.)

8. Power, Environment and Digital I/O

8.3.4 Environmental Status

You can monitor the current status of all configured external EMDs and their sensors, as well as any internal or directly attached sensors.

- Select the **Status: Environmental Status** menu. A table with the summary status of all connected EMD hardware will display.

Status: Environmental Status

Environmental Status
Environmental Logs

Environmental Status

Name	Description	Sensor Status				Connected Via	
		Name	Type	Value	Status		
Comms room	Telco closet	Temperature	Temperature	-u		Serial - Port 3	View Log
		Humidity		Humidity			
		Fire warning		Dry Contact			
		Alarm #2		Dry Contact			

- Click on **View Log** or select the **Environmental Logs** menu. You will be presented with a table and graphical plot of the log history of the select **EMD**.

Status: Environmental Status

Environmental Status
Environmental Logs

EMD (Engineering) - Temperature Graph

EMD (Engineering) - Log

Time	Temperature	Humidity	Alarm #1	Alarm #2	Alert Status
Fri Jan 16 20:37:05 2009	24	51	Open (0)	Open (0)	Normal
Fri Jan 16 20:38:05 2009	24	47	Open (0)	Open (0)	Normal

9. Authentication

The console server platform is a dedicated Linux computer and embodies myriad popular and proven Linux software modules for networking, secure access (OpenSSH), communications (OpenSSL) and sophisticated user authentication (PAM, RADIUS, TACACS+, Kerberos and LDAP).

More details on RSA SecurID and working with Windows IAS can be found on online FAQs.

9.1 Authentication Configuration

Authentication can be performed locally or remotely using an LDAP, Radius, Kerberos or TACACS+ authentication server. The default authentication method for the console server is Local.

System Name: b093-008-2e4u-v Model: B093-008-2E4U-V Firmware: 4.0.0u1
Uptime: 1 days, 1 hours, 31 mins, 31 secs Current User: root

Dashboard Manage Devices Backup Log Out

Serial & Network: Authentication

Authentication Configuration

Authentication Configuration

Authentication Method

- Local
- LocalTACACS
- TACACS
- TACACSLocal
- TACACSDownLocal
- LocalRADIUS
- RADIUS
- RADIUSLocal
- RADIUSDownLocal
- LocalLDAP
- LDAP
- LDAPLocal
- LDAPDownLocal
- LocalKerberos
- Kerberos
- KerberosLocal
- KerberosDownLocal

Authentication Method to use for Web Console, Telnet, SSH, and FTP

Use Remote Groups
Use group membership information provided by remote authentication services

Obfuscate Server Passwords
Store server passwords using a reversible algorithm.
Obfuscation can help prevent accidental password disclosure, however must not be relied upon to provide strong security.

Any authentication method that is configured will be used for authentication of any user who attempts to log in through telnet, SSH or the web manager to the console server, connected serial port and network host devices.

The console server can be configured to the default (**Local**) or an alternate authentication method (**TACACS**, **RADIUS**, **LDAP** or **Kerberos**) with the option of a selected order in which local and remote authentication is used:

Local TACACS /RADIUS/LDAP/Kerberos: Tries local authentication first, then remote if local fails.

TACACS /RADIUS/LDAP/Kerberos Local: Tries remote authentication first, the local if remote fails.

TACACS /RADIUS/LDAP/Kerberos Down Local: Tries remote authentication first, then local if the remote authentication returns an error condition (e.g., the remote authentication server is down or inaccessible).

9.1.1 Local Authentication

- Select **Serial and Network > Authentication**. Check **Local**.
- Click **Apply**.

9. Authentication

9.1.2 TACACS Authentication

Perform the following procedure to configure the TACACS+ authentication method used whenever the console server or any of its serial ports or hosts is accessed:

- Select **Serial and Network > Authentication** and check **TACAS, LocalTACACS, TACACSLocal** or **TACACSDownLocal**.

TACACS+	
Authentication and Authorization Server Address	<input type="text" value="test-services.test.bne.opengear.c"/> Comma separated list of remote authentication and authorization servers.
Disable Accounting	<input type="checkbox"/> Do not send session accounting information.
Accounting Server Address	<input type="text"/> Comma separated list of accounting remote accounting servers. If unset, authentication and authorization server addresses will be used.
Server Password	<input type="password" value="....."/> The shared secret allowing access to the authentication server
Confirm Password	<input type="password" value="....."/>
TACACS Login Method	<input type="radio"/> PAP <input type="radio"/> CHAP <input type="radio"/> Login The method used to authenticate to the server. Defaults to PAP. To use DES encrypted passwords, select Login
TACACS Group Membership Attribute	<input type="text"/> The TACACS attribute that is used to indicate group memberships. Defaults to: groupname#n
TACACS Service	<input type="text"/> The service to authenticate with. This determines which set of attributes are returned by the server. Defaults to <i>raccess</i>
Default Admin Privileges	<input type="checkbox"/> Enable to give all TACACS authenticated users admin privileges. Use Remote Groups must be ticked for the privileges to be granted
Ignore Privilege Level	<input type="checkbox"/> Leave disabled to give TACACS authenticated users with <i>priv-lvl</i> of 12 or greater admin privileges, and <i>priv-lvl</i> of 15 full serial port access.

- Enter the **Server Address** (IP or host name) of the remote authentication/authorization server. Multiple remote servers may be specified in a comma-separated list. Each server is tried in succession.
- Session accounting is on by default. If session accounting information is not desired, check the **Disable Accounting** checkbox. One reason often cited for not wanting session accounting is, if the authentication server does not respond to accounting requests, the said request may introduce a delay when logging in.
- In addition to multiple remote servers, you can also enter separate lists of authentication/authorization servers and accounting servers. If no Accounting servers are specified, the authentication/authorization servers are used.
- Enter and confirm the **Server Password**. Then select the method to be used to authenticate to the server (defaults to **PAP**). To use DES encrypted passwords, select **Login**.
- If required, enter the **TACACS Group Membership Attribute** to be used to indicate group memberships (defaults to **groupname#n**).
- If required, specify the **TACACS Service** used to authenticate. This determines which set of attributes are returned by the server (defaults to **raccess**).
- If required, check **Default Admin Privileges** to give all TACAS+ authenticated users administrator privileges. **Use Remote Groups** must also be checked for these privileges to be granted.
- The TACACS **Privilege Level** feature only applies to TACACS remote authentication. When **Ignore Privilege Level** is enabled, the **priv-lvl** setting for all of the users defined on the TACACS AAA server will be ignored.

Note: A Tripp Lite device normally interprets a user with a TACACS *priv-lvl* of 12 or above as an administrator. There is a special case where a user with a *priv-lvl* of 15 is also given access to all configured serial ports. When the **Ignore Privilege Level** option is enabled (checked in the UI), there are no escalations of privileges based on the *priv-lvl* value from the TACACS server.

If the only thing configured for one or more TACACS users is *priv-lvl* (e.g., no specific port access or group memberships set), console server access will be revoked for those users, as they will not be a member of any groups, even if the Retrieve Remote groups option in the Authentication menu is enabled.

9. Authentication

- Click **Apply**. TACAS+ remote authentication will be used for all user access to the console server and serially or network attached devices

TACACS+ The Terminal Access Controller Access Control System (TACACS+) security protocol is a recent protocol developed by Cisco. It provides detailed accounting information and flexible administrative control over authentication and authorization processes. TACACS+ allows a single access control server (the TACACS+ daemon) to provide authentication, authorization and accounting services independently. Each service can be tied into its own database to take advantage of other services available on that server or network, depending on the capabilities of the daemon. There is a draft RFC detailing this protocol. Further information on configuring remote TACACS+ servers can be found at the following websites:

http://www.cisco.com/en/US/tech/tk59/technologies_tech_note09186a0080094e99.shtml

http://www.cisco.com/en/US/products/sw/secursw/ps4911/products_user_guide_chapter09186a00800eb6d6.html

http://cio.cisco.com/univercd/cc/td/doc/product/software/ios113ed/113ed_cr/secur_c/scprt2/sctplu.htm

9.1.3 RADIUS Authentication

Perform the following procedure to configure the RADIUS authentication method used whenever the console server or any of its serial ports or hosts are accessed:

- Select **Serial and Network: Authentication**. Check **RADIUS, LocalRADIUS, RADIUSLocal** or **RADIUSDownLocal**.

RADIUS	
Authentication and Authorization Server Address	<input type="text" value="autotest-services.test.bne.openg"/> Comma separated list of remote authentication and authorization servers. Custom ports can be specified for each address (e.g. 192.168.0.1:5555).
Disable Accounting	<input type="checkbox"/> Do not send session accounting information.
Accounting Server Address	<input type="text"/> Comma separated list of remote accounting servers. If unset, authentication and authorization server addresses will be used. Custom ports can be specified for each address (e.g. 192.168.0.1:5555).
Server Password	<input type="password" value="....."/> The shared secret allowing access to the authentication server
Confirm Password	<input type="password" value="....."/>

- Enter the **Server Address** (IP or host name) of the remote authentication/authorization server. Multiple remote servers may be specified in a comma-separated list. Each server is tried in succession.
- Session accounting is on by default. If session accounting information is not desired, check the **Disable Accounting** checkbox. One reason often cited for not wanting session accounting is, if the authentication server does not respond to accounting requests, the said request may introduce a delay when logging in.
- In addition to multiple remote servers, you can also enter separate lists of authentication/authorization servers and accounting servers. If no accounting servers are specified, the authentication/authorization servers are used instead.
- Enter the **Server Password**.
- Click **Apply**. RADIUS remote authentication will now be used for all user access to console server and serially or network attached devices.

9. Authentication

RADIUS The Remote Authentication Dial-In User Service (RADIUS) protocol was developed by Livingston Enterprises as an access server authentication and accounting protocol. The RADIUS server can support a variety of methods to authenticate a user. When provided with the username and original password by the user, it can support PPP, PAP or CHAP, UNIX login and other authentication mechanisms. Further information on configuring remote RADIUS servers can be found at the following websites:

<http://www.microsoft.com/technet/prodtechnol/windowsserver2003/library/DepKit/d4fe8248-eeed-49e4-88f6-9e304f97fe9c.mspx>

http://www.cisco.com/en/US/tech/tk59/technologies_tech_note09186a00800945cc.shtml

<http://www.freeradius.org/>

9.1.4 LDAP Authentication

With firmware version 3.11 and later, LDAP authentication now supports OpenLDAP servers using the Posix style schema for user and group definitions.

Performing simple authentication against any LDAP server (AD or OpenLDAP) is straightforward, as both follow common LDAP standards and protocols. More difficult is configuring how to obtain extra data about the users, such as groups they are in, etc.

On a Tripp Lite device, it may be configured to analyze group information from an LDAP server for authentication and authorization. This group information is stored in a number of different ways. Active Directory has one method, and OpenLDAP has two other methods:

- **Active Directory:** Each user entry will have multiple 'memberOf' attributes. Each 'memberOf' value is the full DN of the group they belong to. The entry for the user will be of objectClass "user".
- **OpenLDAP / Posix:** Each entry for a user must have a 'gidNumber' attribute. This will be an integer value, which is the user's primary group (e.g., mapping to the /etc/passwd file with the group ID field). To determine which group this is, search for an entry in the directory that has that group ID, which will provide the group name. The users are of objectClass "posixAccount", and the groups are of objectClass "posixGroup".
- **OpenLDAP / Posix:** Each group entry in the group tree (of objectClass 'posixGroup') may have multiple 'memberUid' attributes. These represent secondary groups (e.g., mapping to the /etc/groups file). Each attribute contains a username.

To accommodate all possibilities, the **pam_ldap** module has been modified to perform group searches for each of the three styles. This allows for a relatively 'generic' configuration and not be concerned with how the LDAP directory is set up.

Only two parameters need to be configured based on what the user wishes to look up: these are the LDAP username and group membership attributes.

To clarify to the user what parameters to use, the descriptions for these fields are updated to prompt the user for common or likely attributes. For example, two configuration fields have descriptions as follows:

LDAP Username Attribute: Corresponds to the login name of the user (commonly 'sAMAccountName' for Active Directory, and 'uid' for OpenLDAP).

LDAP Group Membership Attribute: Indicates group membership in a user record (commonly 'memberOf' for Active Directory, and unused for OpenLDAP).

9. Authentication

LDAP	
Server Address	<input type="text" value="openldap"/> Comma separated list of servers
LDAP Base DN	<input type="text" value="dc=tripplite,dc=com"/> <input type="checkbox"/> Clear this field. The distinguished name of the search base. For example: dc=my-company,dc=com
LDAP Bind DN	<input type="text" value="cn=admin,dc=tripplite,dc=com"/> <input type="checkbox"/> Clear this field. The distinguished name to bind to the server with. The default is to bind anonymously.
Bind DN Password	<input type="password" value="....."/> Password for the Bind DN user
Confirm Password	<input type="password" value="....."/>
LDAP Username Attribute	<input type="text" value="uid"/> The LDAP attribute that corresponds to the login name of the user (commonly 'sAMAccountName' for Active Directory, and 'uid' for OpenLDAP).
LDAP Group Membership Attribute	<input type="text"/> The LDAP attribute that indicates group membership in a user record (commonly 'memberOf' for Active Directory, and unused for OpenLDAP).
LDAP Console Server Group DN	<input type="text" value="cn=MyGroup,ou=Groups,dc=tripplite,dc=com"/> <input type="checkbox"/> Clear this field. The distinguished name of a group on the server which, if set, all users must belong to for any access the console server.
LDAP Basic Management Group DN	(Currently empty) <input type="text"/> The distinguished name of a group on the server whose members will be given <i>users</i> group access.
LDAP Administration Group DN	(Currently empty) <input type="text"/> The distinguished name of a group on the server whose members will be given <i>admin</i> group access.

Note: The *libldap* library is particular about ensuring SSL connections are using certificates signed by a trusted CA. As such, it is often not easy to set up a connection to an LDAP server using SSL.

Perform the following procedure to configure the LDAP authentication method used whenever the console server or any of its serial ports or hosts are accessed:

- Select **Serial and Network: Authentication** and check **LDAP or LocalLDAP or LDAPLocal or LDAPDownLocal**.

9. Authentication

LDAP	
Server Address	<input type="text"/> Comma separated list of servers
Server Protocol	<input type="radio"/> LDAP over SSL preferred <input type="radio"/> LDAP over SSL only <input type="radio"/> LDAP (no SSL) only If SSL should be used and/or enforced for communication with the server
Ignore SSL Certificate Errors	<input type="checkbox"/> Enable if SSL certificate errors should be ignored. If this option is disabled, the server certificate must be signed by a valid CA and the CA public certificate copied to /etc/config/ldaps_ca.crt on this appliance, for LDAP over SSL to succeed.
LDAP Base DN	(Currently empty) <input type="text"/> The distinguished name of the search base. For example: dc=my-company,dc=com
LDAP Bind DN	(Currently empty) <input type="text"/> The distinguished name to bind to the server with. The default is to bind anonymously.
Bind DN Password	<input type="password"/> Password for the Bind DN user
Confirm Password	<input type="password"/>
LDAP Username Attribute	<input type="text"/> The LDAP attribute that corresponds to the login name of the user (commonly 'sAMAccountName' for Active Directory, and 'uid' for OpenLDAP).
LDAP Group Membership Attribute	<input type="text"/> The LDAP attribute that indicates group membership in a user record (commonly 'memberOf' for Active Directory, and unused for OpenLDAP).
LDAP Console Server Group DN	(Currently empty) <input type="text"/> The distinguished name of a group on the server which, if set, all users must belong to for any access the console server.
LDAP Basic Management Group DN	(Currently empty) <input type="text"/> The distinguished name of a group on the server whose members will be given <i>users</i> group access.
LDAP Administration Group DN	(Currently empty) <input type="text"/> The distinguished name of a group on the server whose members will be given <i>admin</i> group

- Enter the **Server Address** (IP or host name) of the remote authentication server. Multiple remote servers may be specified in a comma-separated list. Each server is tried in succession.
- Check the **Server Protocol** box to select if SSL is to be used and/or enforced for communications with the LDAP server. Console servers running firmware version 3.11 and above offer three options for LDAPS (LDAP over SSL):
 - o **LDAP over SSL preferred:** will attempt to use SSL for authentication. If it fails, it will default to LDAP without SSL. For example, LDAP over SSL may fail due to certificate errors or the LDAP server cannot be contacted on the LDAPS port.
 - o **LDAP over SSL only:** will configure the Tripp Lite device to only accept LDAP over SSL. If LDAP over SSL fails, you will only be able to log into the console server as root.
 - o **LDAP (no SSL) only:** will configure the Tripp Lite device to only accept LDAP without SSL. If LDAP without SSL fails, you will only be able to log into the console server as root.
- The **Ignore SSL Certificate Error** checkbox enables you to ignore SSL certificate errors, in effect allowing LDAP over SSL to work, regardless of these errors. You can use any certificate, self-signed or otherwise, on the LDAP server without having to install any certificates on the console server. If this setting is not checked, you must install the CA (certificate authority) certificate with which the LDAP server's certificate was signed onto the console server. For example, the LDAP server provides a certificate signed myCA.crt.

Note: The certificate needs to be in CRT format and myCA.crt needs to be installed on console server at /etc/config/ldaps_ca.crt. Also, the file name must be ldaps_ca.crt. You will need to copy the file to this location and manually name using 'scp' or the like. Some examples include:

```
scp /local/path/to/myCA.c  
rt root@console_server:/etc/config/ldaps_ca.crt
```

9. Authentication

- Enter the **Server Password**.
- Click **Apply**. LDAP remote authentication will now be used for all user access to the console server and serially or network attached devices.

LDAP The Lightweight Directory Access Protocol (LDAP) is based on the X.500 standard, but is significantly simpler and more readily adapted to meet custom needs. The core LDAP specifications are all defined in RFCs. LDAP is a protocol used to access information stored in an LDAP server. Further information on configuring remote RADIUS servers can be found at the following websites:

http://www.ldapman.org/articles/intro_to_ldap.html

<http://www.ldapman.org/servers.html>

<http://www.linuxplanet.com/linuxplanet/tutorials/5050/1/>

<http://www.linuxplanet.com/linuxplanet/tutorials/5074/4/>

9.1.5 RADIUS/TACACS User Configuration

Users may be added to the local console server. If they are not added and they log in via remote AAA, a user will be added for them. This user will not show up in the Tripp Lite configurators unless they are specifically added, at which point they are transformed into a local user. The newly added user must authenticate using the remote AAA server and will have no access if it is down.

If a local user logs in, they may be authenticated/authorized from the remote AAA server, depending on the chosen priority of the remote AAA. A local user's authorization is the union of local and remote privileges.

Example 1:

User Tim is locally added and has access to ports 1 and 2. He is also defined on a remote TACACS server, which says he has access to ports 3 and 4. Tim may log in with either his local or TACACS password, and will have access to ports 1 through 4. If TACACS is down, he will need to use his local password, and will only be able to access ports 1 and 2.

Example 2:

User Sue is only defined on the TACACS server, which says she has access to ports 5 and 6. When she attempts to log in, a new user will be created for her and she will be able to access ports 5 and 6. If the TACACS server is down, she will have no access.

Example 3:

User Paul is defined on a RADIUS server only. He has access to all serial ports and network hosts.

Example 4:

User Don is locally defined on an appliance using RADIUS for AAA. Even if Don is also defined on the RADIUS server, he will only have access to those serial ports and network hosts he has been authorized to use on the appliance.

If a "no local AAA" option is selected, the root will still be authenticated locally.

Remote users may be added to the administrator group via RADIUS or TACACS. Users may have a set of authorizations set on the remote TACACS server. Users automatically added by RADIUS will have authorization for all resources, whereas those added locally will still need their authorizations specified.

LDAP has not been modified and will still need locally defined users.

Note: To interact with RADIUS, TACACS+ and LDAP with console server firmware pre-2.4.2, you must also set up the user accounts on the local console server. All resource authorizations must be added to the local appliance. With this release, if remote AAA is selected, it is used for password checking only. Root is always authenticated locally. Any changes to PAM configurations will be destroyed the next time the authentication configurator is run.

9. Authentication

9.1.6 Group Support with Remote Authentication

All console servers allow remote authentication via RADIUS, LDAP and TACACS+. With firmware version 3.2 and later, RADIUS and LDAP provide additional restrictions on user access based on group information or membership. For example, with remote group support, users can belong to a local group that has been setup to have restricted access to serial ports, network hosts and managed devices.

Remote authentication with group support works by matching a local group name with a remote group name provided by the authentication service. If the list of remote group names returned by the authentication service matches any local group names, the user is given permissions as configured in the local groups.

To enable group support by remote authentication services:

- Select Serial & Network: Authentication.
- Select the relevant Authentication Method.
- Check the Use Remote Groups button.

Serial & Network: Authentication

Authentication Configuration | Authentication Testing

Authentication Configuration

Authentication Method

- Local
- LocalTACACS
- TACACS
- TACACSLocal
- TACACSDownLocal
- LocalRADIUS
- RADIUS
- RADIUSLocal
- RADIUSDownLocal
- LocalLDAP
- LDAP
- LDAPLocal
- LDAPDownLocal
- LocalKerberos
- Kerberos
- KerberosLocal
- KerberosDownLocal

Authentication Method to use for Web Console, Telnet, SSH, and FTP

Use Remote Groups *Use group membership information provided by remote authentication services*

9.1.7 Remote Groups with RADIUS Authentication

Enter the **RADIUS Authentication and Authorization Server Address** and **Server Password**.

Click **Apply**.

RADIUS

Authentication and Authorization Server Address
Comma separated list of remote authentication and authorization servers. Custom ports can be specified for each address (e.g. 192.168.0.1:5555).

Disable Accounting
Do not send session accounting information.

Accounting Server Address
Comma separated list of remote accounting servers. If unset, authentication and authorization server addresses will be used. Custom ports can be specified for each address (e.g. 192.168.0.1:5555).

Server Password
The shared secret allowing access to the authentication server

Confirm Password

9. Authentication

Edit the RADIUS user's file to include group information and restart the RADIUS server.

When using RADIUS authentication, group names are provided to the console server using the Framed-Filter-Id attribute. This is a standard RADIUS attribute and may be used by other devices that authenticate via RADIUS.

To interoperate with other devices using this field, the group names can be added to the end of any existing content in the attribute:

```
:group_name=testgroup1,users:
```

The above example sets the remote user as a member of testgroup1 and users if groups with those names exist on the console server. Any groups that do not exist on the console server are ignored.

When setting the Framed-Filter-Id, the system may also remove the leading colon for an empty field. To work around this, add some dummy text to the start of the string. For example:

```
dummy:group_name=testgroup1,users:
```

- If no group is specified for a user, for example AmandaJones, the user will have no user interface and serial port access, but limited console access.
- Default groups available on the console server include admin for administrator access and users for general user access.

```
TomFraser      Cleartext-Password := "FraTom70"  
               Framed-Filter-Id=":group_name=admin:"  
AmandaJones   Cleartext-Password := "JonAma83"  
FredWhite     Cleartext-Password := "WhiFre62"  
               Framed-Filter-Id=":group_name=testgroup1,users:"  
JanetLong     Cleartext-Password := "LonJan57"  
               Framed-Filter-Id=":group_name=admin:"
```

Additional local groups such as testgroup1 can be added via **Users & Groups: Serial & Network**.

Add a New group

Groups
A group with predefined privileges the user will belong to.

Description
A brief description of the groups role.

Accessible Host(s)

ubuntu (ntp.ubuntu.com)
 Tripp Lite 192.168.254.245

Accessible Port(s)

Select/Unselect all Ports.

Port 1 Port 2 Port 3

Accessible RPC Outlet(s)

baytech

Select/Unselect all outlets.

Outlet 1 Outlet 2 Outlet 3 Outlet 4
 Outlet 5 Outlet 6 Outlet 7 Outlet 8

9. Authentication

9.1.8 Remote Groups with LDAP Authentication

Unlike RADIUS, LDAP has built-in support for group provisioning, which makes setting up remote groups easier. The console server will retrieve a list of all the remote groups the user is a direct member of and compare their names with local groups on the console server.

Note: Any spaces in the group name will be converted to underscores.

For example, in an existing Active Directory setup, a group of users may be part of the **UPS Admin** and **Router Admin** groups. On the console server, these users will be required to have access to a group **Router_Admin**, with access to port 1 (connected to the router), and another group **UPS_Admin**, with access to port 2 (connected to the UPS). Once LDAP is set up, users that are members of each group will have the appropriate permissions to access the router and UPS.

Currently, the only LDAP directory service that supports group provisioning is Microsoft Active Directory. Support is planned for OpenLDAP later.

To enable group information to be used with an LDAP server:

- Complete the fields for standard LDAP authentication, including LDAP Server Address, Server Password, LDAP Base DN, LDAP Bind DN and LDAP Username Attribute.
- Enter `memberOf` for **LDAP Group Membership Attribute**, as group membership is currently only supported on Active Directory servers.
- If required, enter the group information for **LDAP Console Server Group DN** and/or **LDAP Administration Group DN**.

A user must be a member of the LDAP Console Server Group DN group in order to gain access to the console and user interface. For example, the user must be a member of “MyGroup” on the Active Server to gain access to the console server.

Additionally, a user must be a member of the LDAP Administration Group DN in order to gain administrator access to the console server. For example, the user must be a member of “AdminGroup” on the Active Server to receive administration privileges on the console server.

- Click **Apply**.

LDAP	
Server Address	<input type="text" value="192.168.254.18"/> <small>Comma separated list of remote servers.</small>
Server Password	<input type="password" value="••••••"/> <small>The shared secret allowing access to the authentication server.</small>
Confirm Password	<input type="password" value="••••••"/> <small>Re-enter the above password for confirmation.</small>
LDAP Base DN	<input type="text" value="cn=Users,dc=tripplite,dc=con"/> <small>The distinguished name of the search base. For example: dc=my-company,dc=com</small>
LDAP Bind DN	<input type="text" value="cn=Administrator,cn=Users,d"/> <small>The distinguished name to bind to the server with. The default is to bind anonymously.</small>
LDAP Username Attribute	<input type="text" value="sAMAccountName"/> <small>The LDAP attribute corresponding to the login name. On Active Directory servers, the attribute is sAMAccountName</small>
LDAP Group Membership Attribute	<input type="text" value="memberOf"/> <small>The LDAP attribute that is used to indicate group memberships. On Active Directory servers, the attribute is memberOf</small>
LDAP Console Server Group DN	<input type="text" value="cn=MyGroup,cn=Users,dc=con"/> <small>The distinguished name of a group existing on the server which all users with access to the console server must belong to.</small>
LDAP Administration Group DN	<input type="text" value="cn=AdminGroup,cn=Users,dc=con"/> <small>The distinguished name of a group existing on the server whose members will be given admin access</small>

- Ensure the LDAP service is operational and group names are correct within the Active Directory.

9. Authentication

Note: When using remote groups with LDAP remote authorization, you need to have corresponding local groups on the console server. However, where the LDAP group names can contain upper case and space characters, the local group name on the console server must be all lower case and the spaces replaced with underscores. For example, a remote group on the LDAP server may be **My Ldap Access Group** needs a corresponding local group on the console server called **my_ldap_access_group** (both without the single quotes). The local group on the console server must specify what the group member is granted access to for any group membership to be effective.

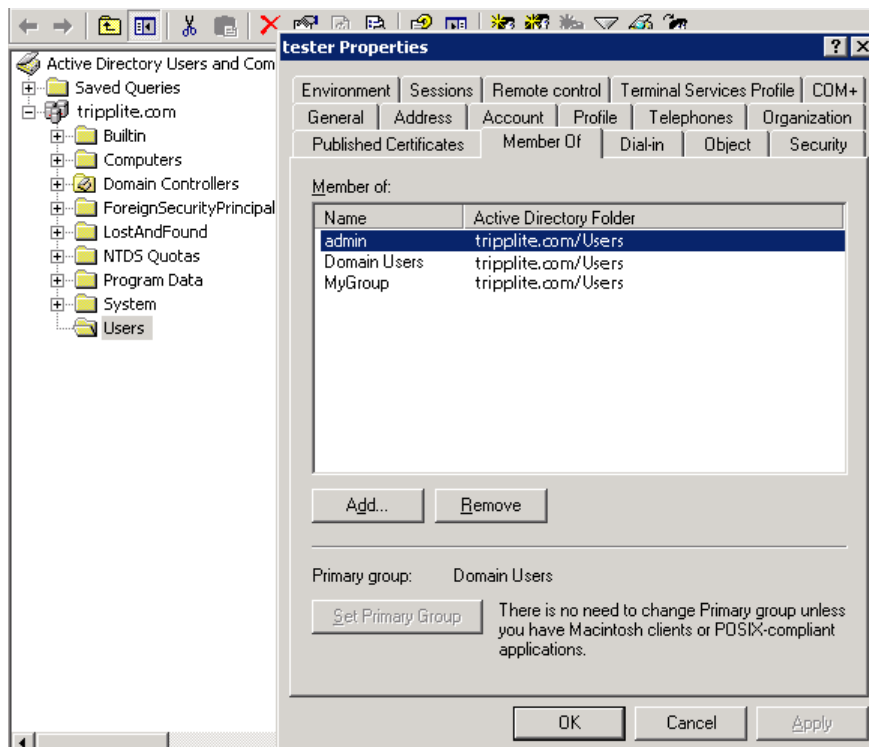

9.1.9 Remote Groups with TACACS+ Authentication

When using TACACS+ authentication, there are two ways to grant a remotely authenticated user privileges. The first is to set the priv-lvl and port attributes of the raccess service to 12 (refer to **9.2 PAM** for more information). Group names can also be provided to the console server using the groupname custom attribute of the raccess service.

An example Linux tac-plus config snippet might look like:

```
user = myuser {
    service = raccess {
        groupname="users"
        groupname1="routers"
        groupname2="dracs"
    }
}
```

You may also specify multiple groups in one comma-delimited (e.g., **groupname="users,routers,dracs"**), but be aware that the maximum length of the attribute value string is 255 characters.

To use an attribute name other than **groupname**, set **Authentication -> TACACS+ -> TACACS Group Membership Attribute**.

9. Authentication

9.1.10 Idle Timeout

You can specify amount of time in minutes the console server waits before it terminates an idle ssh, pmsHELL or web connection.

Web Management Session Timeout	<input type="text"/>	Web Management Console session idle timeout in minutes. The default setting is 20 minutes.
CLI Management Session Timeout	<input type="text"/>	CLI Management Console session idle timeout in minutes. The default setting is to never expire.
Console Server Session Timeout	<input type="text"/>	Serial console server session idle timeout in minutes. The default setting is to never expire.

- Select **Serial and Network: Authentication**.
- **Web Management Session Timeout** specifies the browser console session idle timeout in minutes. The default setting is 20 minutes.
- **CLI Management Session Timeout** specifies the ssh console session idle timeout in minutes. The default setting is to never expire.
- **Console Server Session Timeout** specifies the pmsHELL serial console server session idle timeout in minutes. The default setting is to never expire.

9.1.11 Kerberos Authentication

The Kerberos authentication can be used with UNIX and Windows (Active Directory) Kerberos servers. This form of authentication does not provide group information, so a local user with the same username must be created and permissions set.

Note: Kerberos is very sensitive to time differences between the Key Distribution Center (KDC) authentication server and the client device. Make sure NTP is enabled and the time zone is set correctly on the console server.

When authenticating against Active Directory, the Kerberos Realm will be the domain name and the Primary KDC will be the address of the primary domain controller.

Kerberos V	
Kerberos Realm	<input type="text"/> The domain name of the realm users must authenticate against
Master KDC address	<input type="text"/> The address of the Master KDC to authenticate against
Slave KDC Address	<input type="text"/> The address of a Slave KDC to authenticate against if the Master is not available
Discover Slave KDCs using DNS	<input type="checkbox"/> Use DNS to find slave KDCs. Only enable this if the DNS contains Kerberos information

9. Authentication

9.1.12 Authentication Testing

The Authentication Testing tab (firmware version 3.5.2u3 and later) enables the connection to the remote authentication server to be tested.

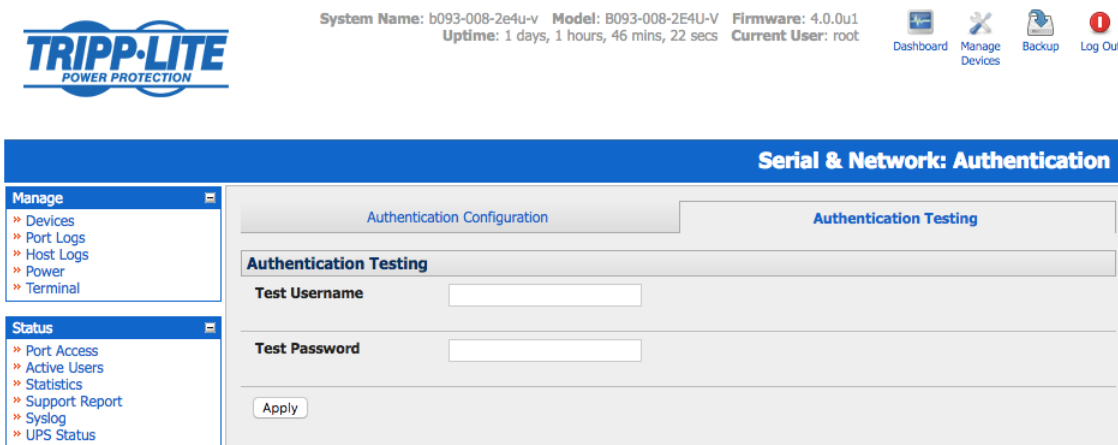

9.2 PAM (Pluggable Authentication Modules)

The console server supports RADIUS, TACACS+ and LDAP for two-factor authentication via PAM (Pluggable Authentication Modules). PAM is a flexible mechanism for authenticating users. A number of new ways of authenticating users have become popular. The challenge is that each time a new authentication scheme is developed, it requires all the necessary programs (login, ftpd, etc.) to be rewritten to support it.

PAM provides a way to develop programs that are independent of authentication scheme. These programs need “authentication modules” to be attached to them at run-time in order to work. Which authentication module is to be attached is dependent upon the local system setup and is at the discretion of the local Administrator.

The console server family supports PAM with the following modules added for remote authentication:

- RADIUS - pam_radius_auth (http://www.freeradius.org/pam_radius_auth/)
- TACACS+ - pam_tacplus (http://echelon.pl/pubs/pam_tacplus.html)
- LDAP - pam_ldap (http://www.padl.com/OSS/pam_ldap.html)

Further modules can be added, as required.

Changes may be made to files in /etc/config/pam.d / which will persist, even if the authentication configurator is run.

- Users added on demand:

When a user attempts to log in, but does not already have an account on the console server, a new user account will be created. This account will have no rights and no password set. They will not appear in the Tripp Lite configuration tools.

Automatically added accounts will not be able to log in if the remote servers are unavailable.

- Administrator rights granted over AAA:

Users may be granted Administrator rights via networked AAA. For TACACS, a priv-lvl of 12 of above indicates an administrator. For RADIUS, administrators are indicated via Framed Filter ID. See the example configuration files below for more information.

- Authorization via TACACS, LDAP or RADIUS for using remote groups:

Refer to **9.1.6 Group Support with Remote Authentication**.

- Authorization via TACACS for both serial ports and host access:

Permission to access resources may be granted via TACACS by indicating a Tripp Lite device and a port or networked host the user may access. See the example configuration files below for more information.

9. Authentication

TACACS Example:

```
user = tim {
  service = raccess {
    priv-lvl = 11
    port1 = b093/port02
  }
  global = cleartext mit
}
```

RADIUS Example:

```
paul Cleartext-Password := "luap"
  Service-Type = Framed-User,
  Fall-Through = No,
  Framed-Filter-Id=":group_name=admin:"
```

The list of groups may include any number of entries separated by a comma. If the administrator group is included, the user will be made an Administrator.

If there is already a Framed-Filter-Id, simply add the list of group_names after the existing entries, including the separating colon ":".

9.3 SSL Certificate

The console server uses the Secure Socket Layer (SSL) protocol for encrypted network traffic between itself and a connected user. While establishing a connection, the console server has to expose its identity to the user's browser using a cryptographic certificate. The default certificate that comes with the console server device upon delivery is for testing purposes only and should not be relied on for secured global access.



The System Administrator should not rely on the default certificate as the secured global access mechanism for use on the Internet.



System Name: b093-008-2efu-v Model: B093-008-2E4U-V Firmware: 4.0.0u1
Uptime: 1 days, 1 hours, 47 mins, 24 secs Current User: root



System: Services

- Manage
 - » Devices
 - » Port Logs
 - » Host Logs
 - » Power
 - » Terminal
- Status
 - » Port Access
 - » Active Users
 - » Statistics
 - » Support Report
 - » Syslog
 - » UPS Status
 - » RPC Status
 - » LLDP/CDP Neighbors
 - » Environmental Status
 - » Dashboard
- Serial & Network
 - » Serial Port
 - » Users & Groups
 - » Authentication
 - » Network Hosts
 - » Trusted Networks
 - » IPsec VPN
 - » OpenVPN
 - » PPTP VPN
 - » Cascaded Ports
 - » UPS Connections
 - » RPC Connections
 - » Environmental
 - » Managed Devices
 - » IP Passthrough

Service Settings

Here you are able to control the services running on this device. Once configured, you can control the network interfaces from which the services can be accessed via the [Service Access](#) tab.

Alternate HTTP Port	<input type="text" value="80"/>	Alternate HTTP port to listen on. <i>NB: The service will still be internally listening on TCP port 80 (for CMS and sdt-connector) but will be inaccessible through the firewall</i>
Enable HTTPS Web Management	<input checked="" type="checkbox"/>	Completely enable or disable the HTTPS web management service
HTTPS Port	<input type="text" value="443"/>	Port to listen for the HTTPS web management service
Enable Telnet command shell	<input checked="" type="checkbox"/>	Completely enable or disable the telnet service
Alternate Telnet Port	<input type="text" value="23"/>	Alternate Telnet port to listen on. <i>NB: The service will still be internally listening on TCP port 23 (for CMS and sdt-connector) but will be inaccessible through the firewall</i>
Enable SSH command shell	<input checked="" type="checkbox"/>	Completely enable or disable the SSH service
SSH Port	<input type="text" value="22"/>	Port to listen for the SSH command shell
Enable SSH DNS	<input type="checkbox"/>	Allow SSH to resolve FQDNs. <i>Warning: this can affect connection performance on networks where DNS is not fully configured.</i>

9. Authentication

Activate your preferred browser and enter https:// IP address. Your browser may respond with a message verifying the validity of the security certificate, while noting that it is not necessarily verified by a trusted authority. To proceed, click Yes if using Internet Explorer or select **Accept this certificate permanently (or temporarily)** if using Mozilla Firefox.

You will be prompted for the administrator account and password.

It is recommended you generate and install a new base64 X.509 certificate that is unique for a particular console server.



System Name: b093-008-2e4u-v Model: B093-008-2E4U-V Firmware: 4.0.0u1
Uptime: 1 days, 1 hours, 49 mins, 45 secs Current User: root



System: SSL Certificates	
Manage	Common name <i>(Currently empty)</i> <input type="text"/> The full canonical name for this device.
Status	Organizational unit <i>(Currently empty)</i> <input type="text"/> The group overseeing this device.
Serial & Network	Organization <i>(Currently empty)</i> <input type="text"/> The name of the organization to which the device belongs.
Alerts & Logging	Locality/City <i>(Currently empty)</i> <input type="text"/> The City where the organization is located.
System	State/Province <i>(Currently empty)</i> <input type="text"/> The State or Province where the organization is located.
» Administration	Country AD <input type="button" value="v"/> The country where the organization is located.
» SSL Certificates	Email <input type="text"/> The email address of a contact person for this device.
» Configuration Backup	Challenge Password <input type="text"/> An optional (dependent on CA) password.
» Firmware	Confirm Password <input type="text"/> Confirmation of the challenge password.
» IP	Key Length (bits) 512 <input type="button" value="v"/> Length of generated key in bits.
» Date & Time	
» Dial	
» Firewall	
» Services	
» DHCP Server	
» Nagios	
» Configure Dashboard	
» Digital I/O	

9. Authentication

The console server must be enabled to generate a new cryptographic key and the associated Certificate Signing Request (CSR) that needs to be certified by a Certification Authority (CA). A certification authority verifies you are the person who you claim you are and signs and issues you a SSL certificate. To create and install an SSL certificate for the console server:

- Select **System: SSL Certificate** and fill out the fields as explained below:

Common name: This is the network name of the console server once it is installed in the network (usually the fully qualified domain name). It is identical to the name that is used to access the console server with a web browser (without the “http://” prefix). In case the name given here and the actual network name differ, the browser will pop up a security warning when the console server is accessed using HTTPS.

Organizational Unit: This field is used for specifying which department the console server belongs within an organization.

Organization: The name of the organization which the console server belongs.

Locality/City: The city where the organization is located.

State/Province: The state or province where the organization is located.

Country: The country where the organization is located. This is the two-letter ISO code (e.g., DE for Germany, or US for the USA). The country code must be entered in capital letters.

Email: The email address of the contact person responsible for the console server and its security.

Challenge Password: Some certification authorities require a challenge password to authorize later changes on the certificate (e.g., revocation of the certificate). The minimal password is 4 characters.

Confirm Challenge Password: Confirmation of the challenge password.

Key Length: This is the length of the generated key in bits. 1024 bits are sufficient for most cases. Longer keys may result in slower console server response time when establishing a connection.

- Click on the **Generate CSR** button to initiate the Certificate Signing Request. The CSR can be downloaded to the Administrator’s machine with the **Download** button.
- Send the saved CSR string to a Certification Authority (CA) for certification. A new certificate from the CA will be sent.
 - Upload the certificate to the console server using the **Upload** button.

The console server should now have its own certificate that is used for identifying the console server to its users.

Note: Information on issuing certificates and configuring HTTPS from the command line can be found in **15. Advanced Configuration**.

10. Nagios Integration

Nagios is a powerful and highly configurable open source tool for monitoring network hosts and services. The core Nagios software package is typically installed on a server or virtual server, the central Nagios server.

Console servers operate in conjunction with a central/upstream Nagios server to provide distributed monitoring of attached network hosts and serial devices. They embed the NSCA (Nagios Service Checks Acceptor) and NRPE (Nagios Remote Plug-in Executor) add-ons, allowing them to communicate with the central Nagios server and eliminating the need for a dedicated secondary Nagios server at remote sites.

Tripp Lite console servers support distributed monitoring. Even if distributed monitoring is not required, the console servers can be deployed locally alongside the Nagios monitoring host serve, to provide additional diagnostics and points of access to managed devices.

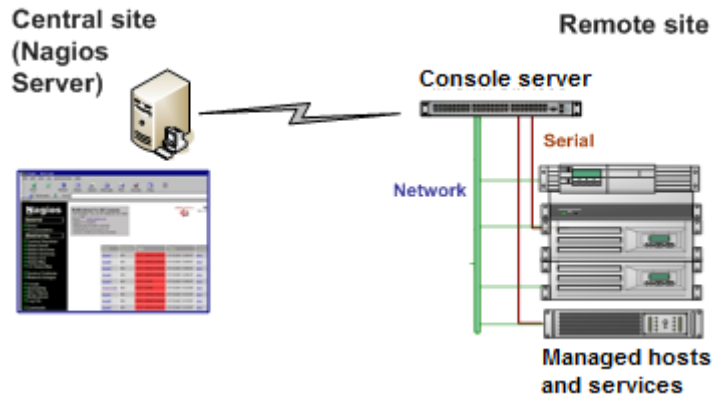

Note: If you have an existing Nagios deployment, you may wish to use the console server gateways in a distributed monitoring server capacity only. If this is the case and you are already familiar with Nagios, skip to section **10.3 Advanced Distributed Monitoring Configuration**.

10.1 Nagios Overview

Nagios provides central monitoring of the hosts and services in your distributed network. Nagios is a free, downloadable, open source software. This section provides a brief overview of Nagios and its capabilities. For a more comprehensive overview, visit <http://www.nagios.org>.

10.2 Configuring Nagios Distributed Monitoring

To activate Nagios distributed monitoring on the console server:

- Nagios integration must be enabled and a path established to the central/upstream Nagios server.
- If the console server is to periodically report on Nagios monitored services, the NSCA client embedded in the console server must be configured in order to enable scheduled check-ins with the remote Nagios server and send passive check results across the network to the remote server.
- If the Nagios server is to actively request status updates from the console server, the NRPE server embedded in the console server must be configured with the Nagios daemon for executing plug-ins on remote hosts.
- Each of the serial ports and hosts connected to the console server to be monitored must have Nagios enabled and any specific Nagios checks configured.
- The central/upstream Nagios monitoring host must be configured.

10. Nagios Integration

10.2.1 Enable Nagios on the Console Server

Select **System: Nagios** on the console server management console and check the service **Enabled** checkbox.

Enabled	<input type="checkbox"/>	Switch on the Nagios service.
Nagios Host Name	<input type="text"/>	Name of this system in Nagios. <i>Generated from System Name if unspecified.</i>
Nagios Host Address	<input type="text"/>	Address for Nagios to find this device at. <i>Defaults to Network 1 IP if set.</i>
Nagios Server Address	<input type="text"/>	Address of the upstream server.
Disable SDT Nagios Extensions	<input type="checkbox"/>	Don't show sdt:// links in service status.
SDT Gateway Address	<input type="text"/>	External address of this system, shown in sdt:// links. <i>Defaults to Nagios Host Address.</i>
Prefer NRPE	<input type="checkbox"/>	Use NRPE instead of NSCA whenever possible. <i>Defaults to prefer NSCA.</i>

Enter the **Nagios Host Name** the **console server** will be referred to in the Nagios central server. This will be generated from local System Name (entered in **System: Administration**) if unspecified.

In **Nagios Host Address**, enter the IP address or DNS name the upstream Nagios server will use to reach the console server. If unspecified, this will default to the first network port's IP (**Network (1)**) as entered in **System: IP**.

In **Nagios Server Address**, enter the IP address or DNS name the console server will use to reach the upstream Nagios monitoring server.

Check the **Disable SDT Nagios Extensions** option if you wish to disable the SDT connector integration with your Nagios server at the head end. Only select this option if you want to run basic Nagios monitoring.

Otherwise, enter the IP address or DNS name the SDT Nagios clients will use to connect the console server in **SDT Gateway Address**.

When NRPE and NSCA are both enabled, NSCA is the preferred method for communicating with the upstream Nagios server. Make sure to check **Prefer NRPE** to use NRPE whenever possible (i.e., for all communication except for alerts).

10. Nagios Integration

10.2.2 Enable NRPE Monitoring

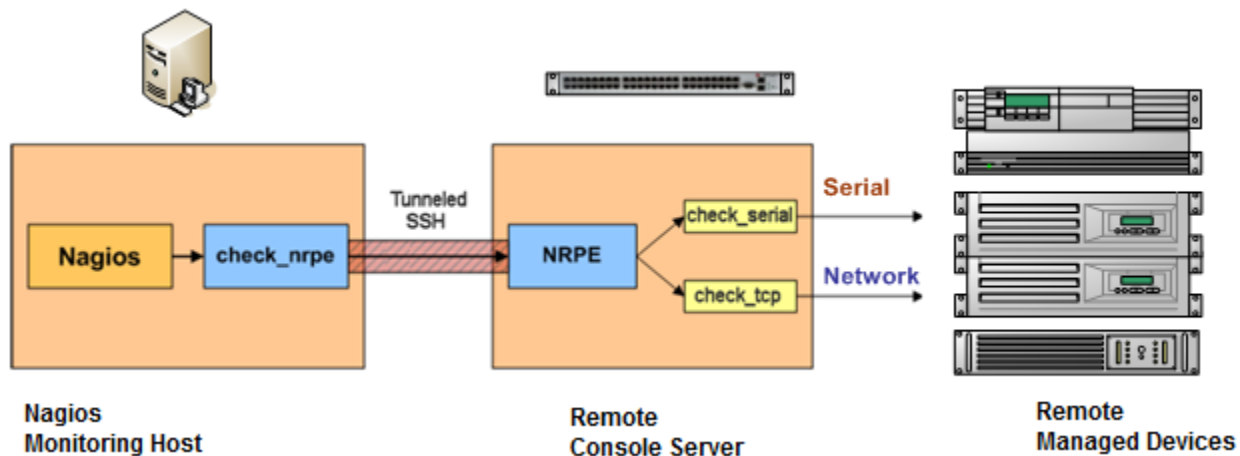

Enabling NRPE allows you to execute plug-ins such as **check_tcp** and **check_ping** on the remote console server to monitor serial or network attached remote servers. This will offload the CPU from the upstream Nagios monitoring machine, which is especially valuable if monitoring hundreds or thousands of hosts. To enable NRPE:

NRPE	
NRPE Enabled	<input type="checkbox"/> Switch on the NRPE service.
NRPE Port	<input type="text"/> Port to listen on for NRPE. Defaults to 5666.
NRPE User	<input type="text"/> User to run as Defaults to nrpe.
NRPE Group	<input type="text"/> Group to run as. Defaults to nobody.
NRPE Command Arguments	<input type="checkbox"/> Allow command arguments for NRPE service.

- Select **System: Nagios** and check **NRPE Enabled**.
- Enter the user details to connect the upstream Nagios monitoring server. Refer to the sample Nagios configuration example below for details of configuring specific NRPE checks.

By default, the console server will accept a connection between the upstream Nagios monitoring server and the NRPE server with SSL encryption, without SSL, or tunneled through SSH. The security for the connection is configured at the Nagios server.

10. Nagios Integration

10.2.3 Enable NSCA Monitoring

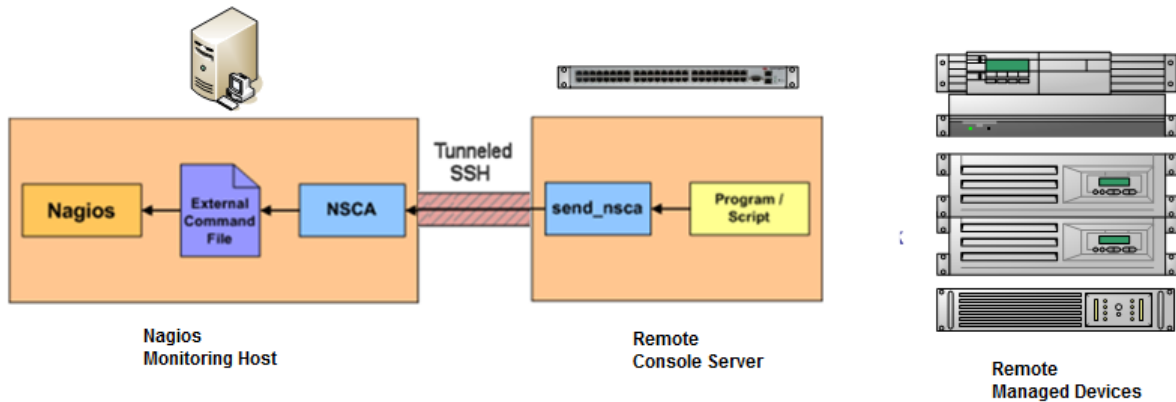

NSCA sends passive check results from the remote console server to the Nagios daemon running on the monitoring server. To enable NSCA:

NSCA	
NSCA Enabled	<input checked="" type="checkbox"/> Schedule check-ins with the NSCA server.
NSCA Encryption	<input type="text" value="None"/> Type of encryption.
NSCA Secret	<input type="text"/> Password for NSCA.
NSCA Confirm	<input type="text"/> Re-enter password for NSCA.
NSCA Interval	<input type="text" value="4354"/> Check-in frequency in minutes.
NSCA Port	<input type="text"/> Port to connect to. Defaults to 5667.
NSCA User	<input type="text"/> User to run as Defaults to nsca.
NSCA Group	<input type="text"/> Group to run as. Defaults to nobody.

- Select **System: Nagios** and check **NSCA Enabled**.
- Select the **Encryption** to be used from the dropdown menu. Enter a **Secret** password and specify a check **Interval**.
- Refer to the sample Nagios configuration section below for examples of configuring specific NSCA checks.

10. Nagios Integration

10.2.4 Configure Selected Serial Ports for Nagios Monitoring

Individual serial ports connected to the console server to be monitored must be configured for Nagios checks (refer to **4.4 Network Host Configuration** for details on enabling Nagios monitoring for hosts that are network-connected to the console server). To enable Nagios to monitor a device connected to the console server serial port:

- Select **Serial & Network: Serial Port** and click **Edit** on the serial port to be monitored.
- Select **Enable Nagios**, specify the name of the device on the upstream server and determine the check to be run on this port. **Serial Status** monitors the handshaking lines on the serial port and **Check Port** monitors the data logged for the serial port.

Nagios Settings

Enable Nagios
Switch Nagios on for this port

Host Name
Name of host in Nagios. Defaults to host name if unset

Port Log
Switch on Nagios port logging

Serial Status
Switch on Nagios serial status

Apply

10.2.5 Configure Selected Network Hosts for Nagios Monitoring

The individual network hosts connected to the console server to be monitored must also be configured for Nagios checks:

- Select **Serial & Network: Network Port** and click **Edit** on the network host to be monitored.

Nagios Settings

Enable Nagios
Switch Nagios on for this host

Host Name
Name of host in Nagios. Defaults to host name if unset

Nagios Checks

- Select **Enable Nagios** and specify the name of the device as it will appear on the upstream Nagios server.
- Click **New Check** to add a specific check to be run on this host.
- Select **Check Permitted TCP/UDP** to monitor a service you have previously added as a **Permitted Service**.
- Select **Check TCP/UDP** to specify a service port you wish to monitor, but do not wish to allow external (SDT Connector) access to.
- Select **Check TCP** to monitor.

10. Nagios Integration

The screenshot shows the 'Nagios Settings' form. At the top, there is a checkbox for 'Enable Nagios' which is currently unchecked. Below that is a text input field for 'Host Name'. The 'Nagios Checks' section contains a table with one row. The first column has the number '1'. The second column is a dropdown menu with 'Check NRPE' selected. The third column is another dropdown menu with 'Use Default Args' selected. The fourth column is a text input field containing 'check-host-alive'. To the right of this field is a radio button that is currently selected. There is a 'Delete' button to the right of the radio button. Below the table, there is a 'Default Args' field containing '-H %HOST% -c %COMMAND%'. At the bottom of the form is an 'Apply' button.

- The **Nagios Check** assigned as the **check-host-alive** check determines whether the network host is up or down.
- Typically, this will be **Check Ping**. In some cases, the host will be configured to not respond to pings.
- If no **check-host-alive** is selected, the host will always be assumed to be up.
- You may deselect **check-host-alive** by clicking **Clear check-host-alive**.
- If required, customize the selected **Nagios Checks** to use custom arguments.
- Click **Apply**.

This screenshot shows the 'Nagios Settings' form with the 'Nagios Checks' section expanded. The dropdown menu for the first check is open, showing options: 'Use Default Args', 'Use Default Args', 'Override Default Args', and 'Add to default args'. The 'Use Default Args' option is selected. Below the table, there are two buttons: 'New Check' and 'Clear check-host-alive'. The 'Apply' button is at the bottom.

10.2.6 Configure the Upstream Nagios Monitoring Host

Refer to the Nagios documentation (found at <http://www.nagios.org/docs/>) for configuring the upstream server:

- The section **Distributed Monitoring** provides step-by-step detail for configuring NSCA on the upstream server (under **Central Server Configuration**).
- **NRPE Documentation** has recently added steps for configuring NRPE on the upstream server. For more information, visit <http://nagios.sourceforge.net/docs/nrpe/NRPE.pdf>.

At this point, Nagios upstream monitoring server has been configured and individual serial port and network host connections on the console server have been configured for Nagios monitoring. If NSCA is enabled, each selected check will be executed once over the period of the check interval. If NRPE is enabled, the upstream server will be able to request status updates under its own scheduling.

10. Nagios Integration

10.3 Advanced Distributed Monitoring Configuration

10.3.1 Sample Nagios Configuration

An example configuration for Nagios is listed below. The example configuration shows how to set up a remote console server to monitor a single host with both network and serial connections. Each check contains two configurations: one for NRPE and one for NSCA. In practice, these would be combined into a single check using NSCA as a primary method and defaulting to NRPE if checked late. For more information, refer to Nagios documentation (<http://www.nagios.org/docs/>) on **Service and Host Freshness Checks**.

```
; Host definitions
;
; Tripp Lite Console server
define host{
    use          generic-host
    host_name    tripp-lite
    alias        Console server
    address      192.168.254.147
}

; Managed Host
define host{
    use          generic-host
    host_name    server
    alias        server
    address      192.168.254.227
}

; NRPE daemon on gateway
define command {
    command_name check_nrpe_daemon
    command_line $USER1$/check_nrpe -H 192.168.254.147 -p 5666
}

define service {
    service_description    NRPE Daemon
    host_name              tripp-lite
    use                    generic-service
    check_command          check_nrpe_daemon
}

; Serial Status
define command {
    command_name check_serial_status
    command_line $USER1$/check_nrpe -H 192.168.254.147 -p 5666 -c check_serial_$HOSTNAME$
}

define service {
    service_description    Serial Status
    host_name              server
    use                    generic-service
    check_command          check_serial_status
}

define service {
    service_description    serial-signals-server
    host_name              server
    use                    generic-service
    check_command          check_serial_status
    active_checks_enabled 0
    passive_checks_enabled 1
}
```

10. Nagios Integration

```
define servicedependency{
    name                tripp-lite_nrpe_daemon_dep
    host_name           tripp-lite
    dependent_host_name server
    dependent_service_description Serial Status
    service_description NRPE Daemon
    execution_failure_criteria w,u,c
}

; Port Log
define command{
    command_name check_port_log
    command_line $USER1$/check_nrpe -H 192.168.254.147 -p 5666 -c port_log_$HOSTNAME$
}

define service {
    service_description Port Log
    host_name           server
    use                 generic-service
    check_command       check_port_log
}

define service {
    service_description port-log-server
    host_name           server
    use                 generic-service
    check_command       check_port_log
    active_checks_enabled 0
    passive_checks_enabled 1
}

define servicedependency{
    name                tripp-lite_nrpe_daemon_dep
    host_name           tripp-lite
    dependent_host_name server
    dependent_service_description Port Log
    service_description NRPE Daemon
    execution_failure_criteria w,u,c
}

; Ping
define command{
    command_name check_ping_via_tripp-lite
    command_line $USER1$/check_nrpe -H 192.168.254.147 -p 5666 -c host_ping_$HOSTNAME$
}

define service {
    service_description Host Ping
    host_name           server
    use                 generic-service
    check_command       check_ping_via_tripp-lite
}

define service {
    service_description host-ping-server
    host_name           server
    use                 generic-service
    check_command       check_ping_via_tripp-lite
    active_checks_enabled 0
    passive_checks_enabled 1
}
```

10. Nagios Integration

```
define servicedependency{
    name                tripp-lite_nrpe_daemon_dep
    host_name           tripp-lite
    dependent_host_name server
    dependent_service_description Host Ping
    service_description NRPE Daemon
    execution_failure_criteria w,u,c
}

; SSH Port
define command{
    command_name check_conn_via_tripp-lite
    command_line $USER1$/check_nrpe -H 192.168.254.147 -p 5666 -c host_$HOSTNAME$_$ARG1$_$ARG2$
}

define service {
    service_description SSH Port
    host_name           server
    use                 generic-service
    check_command       check_conn_via_tripp-lite!tcp!22
}

define service {
    service_description host-port-tcp-22-server
    ; host-port-<protocol>-<port>-<host>
    host_name           server
    use                 generic-service
    check_command       check_conn_via_tripp-lite!tcp!22
    active_checks_enabled 0
    passive_checks_enabled 1
}

define servicedependency{
    name                tripp-lite_nrpe_daemon_dep
    host_name           tripp-lite
    dependent_host_name server
    dependent_service_description SSH Port
    service_description NRPE Daemon
    execution_failure_criteria w,u,c
}
```

10.3.2 Basic Nagios Plug-Ins

Plug-ins are compiled executables or scripts that can be scheduled to be run on the console server to check the status of a connected host or service. This status is then communicated to the upstream Nagios server, which uses the results to monitor the current status of the distributed network. Each console server is preconfigured with checks that are part of the Nagios plug-ins package:

check_tcp and **check_udp** are used to check open ports on network hosts.

check_ping is used to check network host availability.

check_nrpe is used to execute arbitrary plug-ins in other devices.

Each **console server** is preconfigured with two checks that are specific to Tripp Lite:

check_serial_signals is used to monitor the handshaking lines on the serial ports.

check_port_log is used to monitor the data logged for a serial port.

10. Nagios Integration

10.3.3 Additional Plug-Ins

Additional Nagios plug-ins (listed below) are available for all B097 and B098 models:

```
check_apt
check_by_ssh
check_clamd
check_dig
check_dns
check_dummy
check_fping
check_ftp
check_game
check_hpjd
check_http
check_imap
check_jabber
check_ldap
check_load
check_mrtg
check_mrtgtraf
check_nagios
check_nntp
check_nntps
check_nt
check_ntp
check_nwstat
check_overcr
check_ping
check_pop
check_procs
check_real
check_simap
check_sntp
check_snmp
check_spop
check_ssh
check_ssmtp
check_swap
check_tcp
check_time
check_udp
check_ups
check_users
```

Bash scripts can also be downloaded and run (primarily **check_log.sh**).

10. Nagios Integration

To configure additional checks, the downloaded plug-in program must be saved in the **tftp addins** directory on the USB flash and the downloaded text plug-in file saved in **/etc/config**.

To enable these new additional checks, select **Serial & Network: Network Port**. Select **Edit** for the network host to be monitored and **New Checks**. The additional check option will be included in the updated **Nagios Checks** list, where you can again customize the arguments.

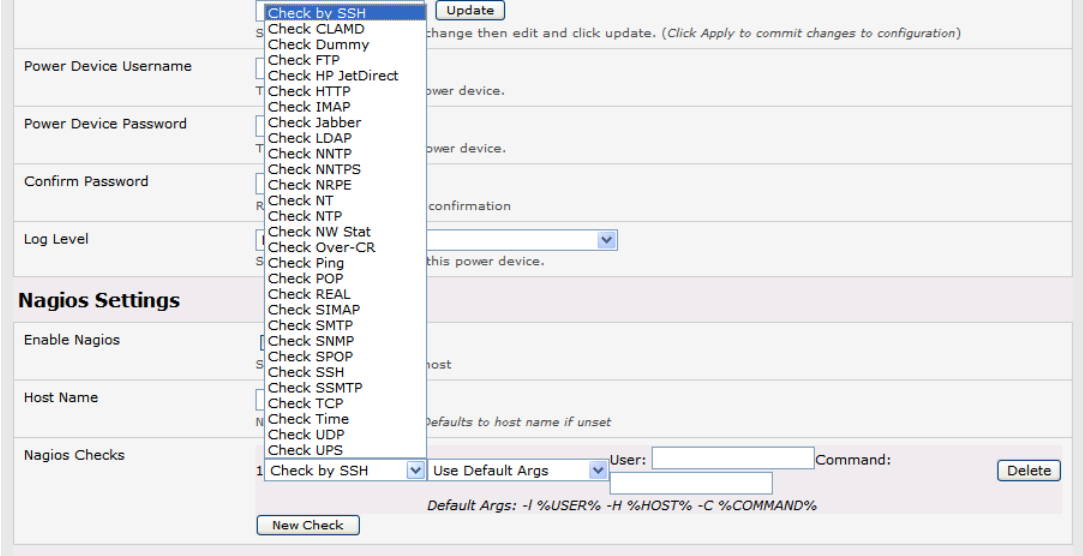

10.3.4 Number of Supported Devices

The number of devices that can be supported by a console server is a function of the number of checks being made and how often they are performed. Access method also plays a role. The table below shows the performance of three console server models (1/2 port, 8 port and 16/48 port):

Time	No encryption	3DES	SSH tunnel
NSCA for single check	~ 1/2 second	~ 1/2 second	~ 1/2 second
NSCA for 100 sequential checks	100 seconds	100 seconds	100 seconds
NSCA for 10 sequential checks, batched upload	1 1/2 seconds	2 seconds	1 second
NSCA for 100 sequential checks, batched upload	7 seconds	11 seconds	6 seconds

	No encryption	SSL	no encryption - tunneled over existing SSH session
NRPE time to service 1 check	1/10th second	1/3rd second	1/8th second
NRPE time to service 10 simultaneous checks	1 second	3 seconds	1 1/4 seconds
Maximum number of simultaneous checks before timeouts	30	20 (1,2 and 8) or 25 (16 and 48 port)	25 (1,2 and 8 port), 35 (16 and 48 port)

The results were from running tests five times in succession with no timeouts on any runs. However, there are a number of ways to increase the number of checks you can do:

When using NRPE checks, an individual request will need to set up and tear down an SSL connection. This overhead can be avoided by setting up an SSH session to the console server and tunneling the NRPE port. This allows the NRPE daemon to run securely without SSL encryption, as SSH will handle security.

When the console server submits NSCA results, it staggers them over a time period (e.g., 20 checks over 10 minutes will result in two check results every minute). Staggering the results like this means that in the event of a power failure or other incident that causes multiple problems, the individual refresh checks will be staggered too.

NSCA checks are also batched. In the previous example, the two checks per minute will be sent through in a single transaction.

10. Nagios Integration

10.3.5 Distributed Monitoring Usage Scenarios

Below are examples of distributed monitoring Nagios scenarios:

Local office

In this scenario, the console server is set up to monitor the console of each managed device. It can be configured to perform a number of checks (actively at the Nagios server's request, or passively at preset intervals) and submit the results to the Nagios server in a batch.

The console server may be augmented at the local office site by one or more Intelligent Power Distribution Units (IPDUs) to remotely control the power supply to the managed devices.

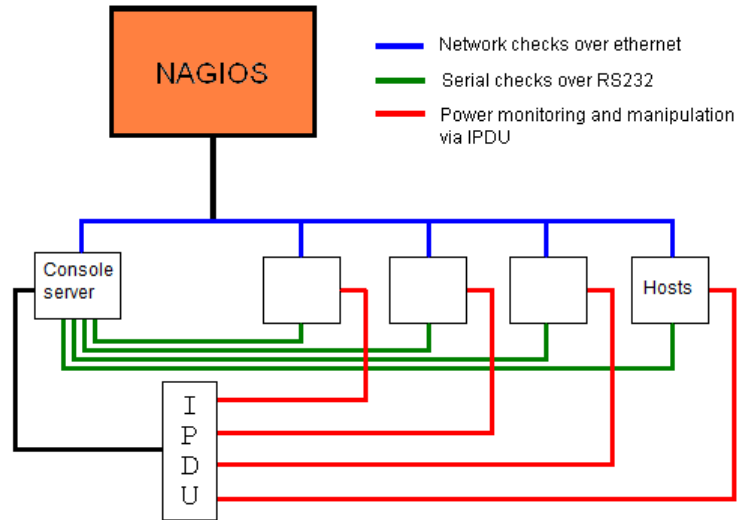

Remote site

In this scenario, the console server, NRPE server or NSCA client can be configured to make active checks of configured services and upload to the Nagios server waiting passively. It can also be configured to service NRPE commands to perform checks on demand.

In this situation, the console server will perform checks based on both serial and network access.

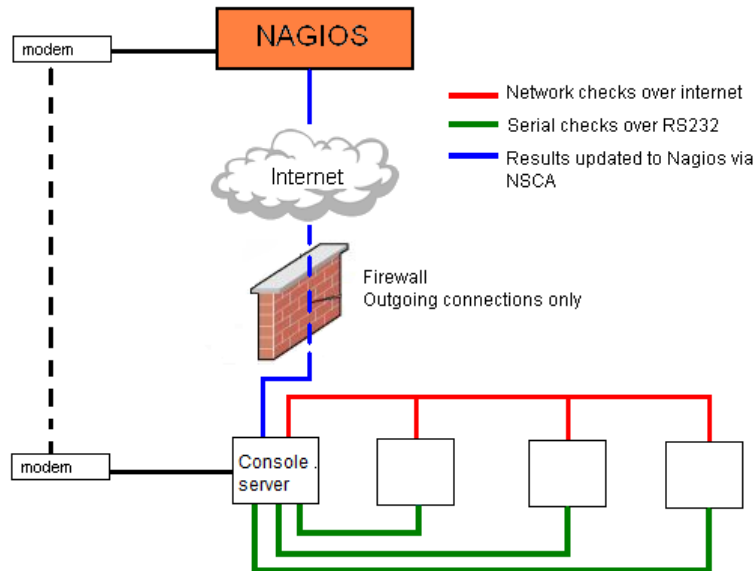

10. Nagios Integration

Remote Site with Restrictive Firewall

In this scenario, the console server's role will vary. One aspect may be to upload check results through NSCA. Another may be to provide an SSH tunnel to allow the Nagios server to run NRPE commands.

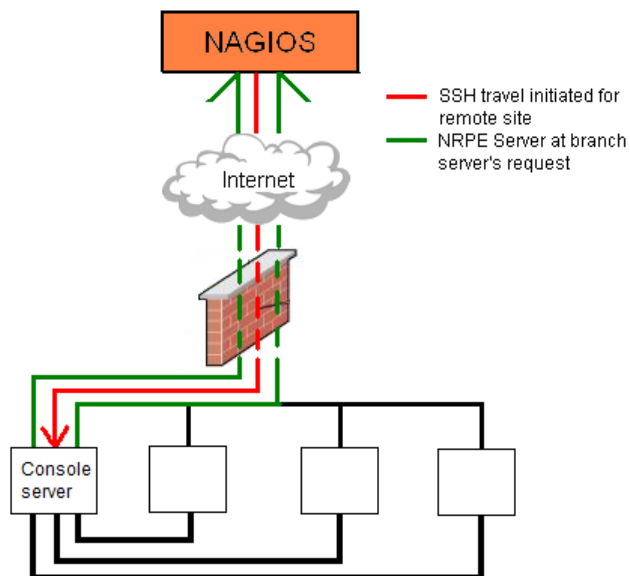

Remote Site with No Network Access

In this scenario, the console server allows dial-in access to the Nagios server. Periodically, the Nagios server will establish a connection to the console server and execute any NRPE commands before dropping the connection.

11. System Management

This chapter describes how the Administrator can perform a range of general console server system administrative and configuration tasks.

11.1 System Administration and Reset

The Administrator can reboot or reset the gateway to default settings.

To perform a soft reset:

- Select **Reboot** in the **System: Administration** menu and click **Apply**.

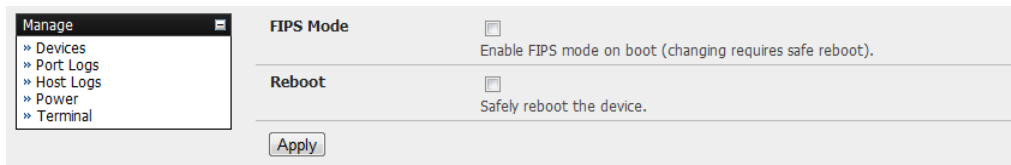

The screenshot shows a web interface for system administration. On the left, a 'Manage' dropdown menu is open, listing 'Devices', 'Port Logs', 'Host Logs', 'Power', and 'Terminal'. To the right, there are two configuration sections: 'FIPS Mode' with a checkbox and the text 'Enable FIPS mode on boot (changing requires safe reboot).', and 'Reboot' with a checkbox and the text 'Safely reboot the device.'. Below these sections is an 'Apply' button.

The console server reboots with all settings (e.g., the assigned network IP address) preserved. However, this soft reset disconnects all users and ends any SSH sessions that had been established.

A soft reset will also be affected when you switch OFF power from the console server and switch the power back ON. If you cycle the power and the unit is writing data to flash memory, you could corrupt or lose data. As such, a software reboot is the safer option.

To perform a hard erase (hard reset):

- Push the **Erase** button on the rear panel twice. A ballpoint pen or bent paper clip is a suitable tool for performing this procedure. **Do not use a graphite pencil.** Depress the button gently twice (within a couple of second period) while the unit is powered ON.

This will reset the console server to its factory default settings and clear the console server's stored configuration information (i.e. the IP address will be reset to 192.168.0.1). You will be prompted to log in and must enter the default administration username and administration password (Username: **root** Password: **default**).

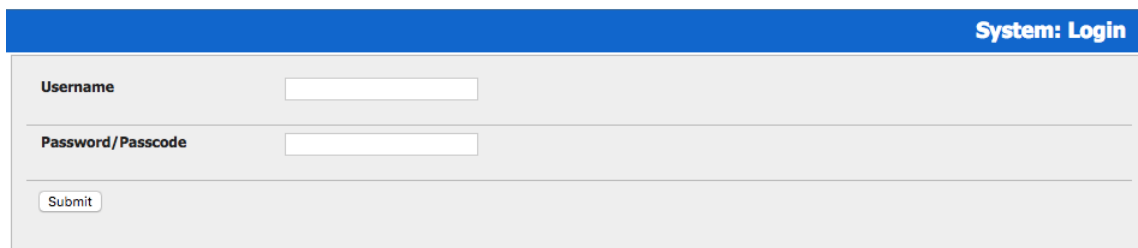

The screenshot shows a login form titled 'System: Login'. It has a blue header bar with the title. Below the header, there are two input fields: 'Username' and 'Password/Passcode'. Below the password field is a 'Submit' button.

11. System Management

11.2 Upgrade Firmware

Before upgrading, you should determine whether your Tripp Lite device is running the most current firmware. Your Tripp Lite device will not allow you to upgrade to the same version or an earlier version.

- The **Firmware** version is displayed in the header of each page.
- Alternately, selecting **Status: Support Report** reports the **Firmware Version**.
- To upgrade, you first must download the latest firmware image from www.tripplite.com/support.
- Save this downloaded firmware image file on to a system on the same subnet as the Tripp Lite device.
- Download and read the Release Notes file for the latest update information.
- To upload the firmware image file, select **System: Firmware**.
- Specify the address and name of the downloaded Firmware Upgrade File, or **Browse** the local subnet and locate the downloaded file.
- Click **Apply**. The Tripp Lite device will undergo a soft reboot and begin upgrading the firmware. This process will take several minutes.
- After the firmware upgrade has completed, click **here** to return to the management console. Your Tripp Lite device will have retained all pre-upgrade configuration information.

11.3 Configure Date and Time

It is important to set the local date and time in your Tripp Lite device as soon as it is configured. Features such as Syslog and NFS logging use the system time for time-stamping log entries, while certificate generation depends on a correct timestamp to check the validity period of the certificate.

Your Tripp Lite appliance can synchronize its system time with a remote Network Time Protocol (NTP) server. NTP uses Coordinated Universal Time (UCT) for all time synchronizations, so it is not affected by different time zones. However, you will need to specify your local time zone in order for the system clock to show the correct local time:

- Set your appropriate region/locality in the **Time Zone** selection box and click **Set Timezone**.

The screenshot shows the Tripp Lite management console interface. At the top, the Tripp Lite logo is on the left, and system information is on the right: System Name: b093-008-2e4u-v, Model: B093-008-2E4U-V, Firmware: 4.0.0u1, Uptime: 1 days, 2 hours, 4 mins, 6 secs, Current User: root. Navigation icons for Dashboard, Manage Devices, Backup, and Log Out are also present.

The main content area is titled "System: Date & Time". On the left is a navigation menu with categories: Manage, Status, Serial & Network, Alerts & Logging, and System. The System menu is expanded to show options like Administration, SSL Certificates, Configuration Backup, Firmware, IP, Date & Time, Dial, Firewall, Services, DHCP Server, Nagios, Configure Dashboard, and Digital I/O.

The "Date & Time" configuration section includes:

- Time Zone:** A dropdown menu set to "UCT" with the instruction "Select your timezone." and an "Apply Time Zone" button.
- Date and Time:** Fields for Year (2017), Month (January), Day (01), Hour (21), and Minute (04), with an "Apply Date and Time" button.
- Network Time Protocol:** An "Enable NTP" checkbox (unchecked) with the text "Enable Network-Time-Protocol Support."
- NTP Server List:** A table with columns for "Remote NTP Server Address", "NTP Authentication Key" (with a note "if NTP authentication is required"), and "NTP Authentication Key Index" (with a note "Must be the same between the server and client"). A "New Server" button is at the bottom.

11. System Management

Note: With firmware version 3.2.0, the time zone can also be set to UCT, which replaced Greenwich Mean Time (GMT) as the world standard for time.

Configuring NTP ensures the Tripp Lite device's clock is accurate (once Internet connection has been established).

- Select the **Enable NTP** checkbox in the **Network Time Protocol** section of the **System: Date & Time** page.
- Enter the IP address of the remote **NTP Server**.
- If your external NTP server requires authentication, specify the **NTP Authentication Key** and the **Key Index** to use when authenticating with the NTP server.
- Click **Apply NTP Settings**.

Network Time Protocol

Enable NTP Enable Network-Time-Protocol Support.

NTP Server List	Remote NTP Server Address	NTP Authentication Key <i>if NTP authentication is required</i>	NTP Authentication Key Index <i>Must be the same between the server and client</i>
<input type="button" value="New Server"/>			

If remote NTP is not used, the time can be set manually:

- Enter the **Year, Month, Day, Hour** and **Minute** using the **Date** and **Time** selection boxes.
- Check **Set Time**.

Notes:

- All Tripp Lite devices have an internal battery-backed hardware clock. When the time and date is set manually through the management console or retrieved from an NTP server, the hardware clock of the Tripp Lite device is automatically updated. The hardware clock uses a battery to allow the current time and date to be maintained across reboots and after the appliance has been powered down for longer periods.
- With the NTP peering model, the Tripp Lite device can share its time information with other devices connected to it so all devices can be time synchronized. To do this, click **Enable NTP** on the Time and Date page and ensure the appropriate networks are selected on the **Service Access** tab under **System: Services**.

System: Services						
Service Settings				Service Access		
Services	Service Enabled	Network Interface	Management LAN	Dialout/Cellular	Dial-in	VPN
NTP Server	Enabled	<input type="checkbox"/>	<input checked="" type="checkbox"/>	<input type="checkbox"/>	<input checked="" type="checkbox"/>	<input checked="" type="checkbox"/>

11. System Management

11.4 Configuration Backup

It is recommended that you back up the console server configuration whenever you make significant changes (such as adding new users or managed devices) or before performing a firmware upgrade.

Select the **System: Configuration Backup** menu option or click the  icon.

Note: The configuration files can also be backed up from the command line (refer to 14. Configuration from the Command Line).

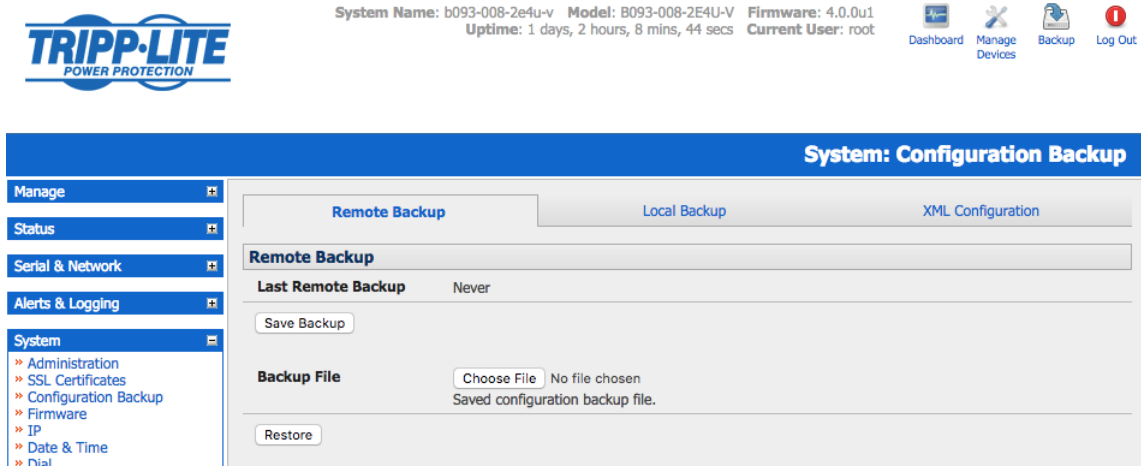

The screenshot shows the Tripp-Lite console server web interface. At the top left is the Tripp-Lite logo. To the right, system information is displayed: System Name: b093-008-2e4u-v, Model: B093-008-2E4U-V, Firmware: 4.0.0u1, Uptime: 1 days, 2 hours, 8 mins, 44 secs, Current User: root. Navigation icons for Dashboard, Manage Devices, Backup, and Log Out are visible. The main content area is titled "System: Configuration Backup" and features a sidebar menu with options like Manage, Status, Serial & Network, Alerts & Logging, and System. The System menu is expanded to show Administration, SSL Certificates, Configuration Backup, Firmware, IP, Date & Time, and Dial. The main panel has tabs for Remote Backup, Local Backup, and XML Configuration. The Remote Backup tab is active, showing a "Last Remote Backup" of "Never", a "Save Backup" button, a "Backup File" section with a "Choose File" button and "No file chosen" text, and a "Restore" button.

With all console server models, you can save the backup file remotely on your PC and restore configurations from remote locations:

- Click **Save Backup** in the **Remote Configuration Backup** menu.
- The config backup file (**System Name_date_config.opg**) will be downloaded to your PC and saved in the location you assign.

To restore a remote backup:

- Click Browse in the Remote Configuration Backup menu and select the Backup File you wish to restore.
- Click Restore, then click OK. This will overwrite all current configuration settings in your console server.

Some console server models allow you to save the backup file locally onto the USB storage. To do so, your console server must support USB and have an internal or external USB flash drive installed.

11. System Management

To backup and restore using USB:

- Ensure the USB flash is the only USB device attached to the console server.
- Select the **Local Backup** tab and **click here to proceed**. This will set a volume label on the USB storage device. This preparation step is only necessary the first time and will not affect any other information saved onto the USB storage device. It is recommended you back up any critical data from the USB storage device before using it with your console server. If there are multiple USB devices installed, you will be asked to remove them.



System Name: b093-008-2e4u-v Model: B093-008-2E4U-V Firmware: 4.0.0u1
Uptime: 1 days, 2 hours, 9 mins, 37 secs Current User: root



- To back up to USB, enter a brief **Description** of the backup in the Local Backup menu and select **Save Backup**.
- The Local Backup menu will display all configuration backup files stored onto the USB flash.
- To restore a backup from the USB, simply select **Restore** on the particular backup you wish to restore and click **Apply**.

After saving a local configuration backup, you may choose to use it as the alternate default configuration. When the console server is reset to factory default, it will load your alternate default configuration (instead of its factory settings):

- To set an alternate default configuration, check **Load On Erase** and click **Apply**.

Note: Before selecting **Load On Erase**, ensure you have tested your alternate default configuration by clicking **Restore**.

If for some reason your alternate default configuration causes the console server to become unbootable, recover your unit to factory settings using the following steps:

- If the configuration is stored on an external USB storage device, unplug the storage device and reset to factory defaults (refer to **11.1 System Administration and Reset**).
- If the configuration is stored on an internal USB storage device, reset to factory defaults using a specially prepared USB storage device:
 - o The USB storage device must be formatted with a Windows FAT32/VFAT file system on the first partition or the entire disk (most USB thumb drives are already formatted this way).
 - o The file system must have the volume label: OPG_DEFAULT.
 - o Insert this USB storage device into an external USB port on the console server and reset to factory defaults as per section **11.1 System Administration and Reset**.

After recovering your console server, ensure the problematic configuration is no longer selected for Load On Erase.

11. System Management

11.5 Delayed Configuration Commit

This mode allows the grouping or queuing of configuration changes and the simultaneous application of these changes to a specific device. For example, changes to authentication methods or user accounts may be grouped and run once to minimize system downtime. To enable:

- Check the **Delayed Config Commits** button under **System: Administration**.
- Click **Apply**.

The screenshot shows the Tripp-Lite System Administration interface. At the top, the system name is b093-008-2e4u-v, model is B093-008-2E4U-V, firmware is 4.0.0u1, and uptime is 1 days, 2 hours, 10 mins, 49 secs. The current user is root. Navigation icons for Dashboard, Manage Devices, Backup, and Log Out are visible. The main content area is titled 'System: Administration' and contains a sidebar menu with options like Manage, Status, Serial & Network, Alerts & Logging, and System. The System menu is expanded, showing sub-options like Administration, SSL Certificates, Configuration Backup, Firmware, IP, Date & Time, Dial, Firewall, Services, DHCP Server, Nagios, Configure Dashboard, and Digital I/O. The main configuration area has fields for System Name (b093-008-2e4u-v), System Description, System Password, MOTD Banner, and Delayed Config Commits (checked). An Apply button is at the bottom.

- The Commit Config icon will display in top right-hand corner of the screen between the Backup and Log Out icons.

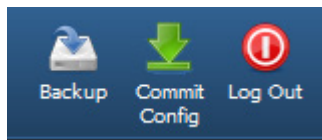

11. System Management

To queue, then run configuration changes:

- First, apply all the required changes to the configuration (e.g., modify user accounts, amend authentication method, enable OpenVPN tunnel or modify system time).
- Click the **Commit Config** button. This will generate the **System: Commit Configuration** screen displaying all the configurators to be run.

System Name: b093-008-2e4u-v Model: B093-008-2E4U-V Firmware: 4.0.0u1
Uptime: 1 days, 2 hours, 15 mins, 22 secs Current User: root

Dashboard Manage Devices Backup Commit Config Log Out

System: Commit Configuration

The following configurators will be run on config commit:

- autoreponse
- cascade
- conman
- console
- dhcp
- dialin
- enviro
- forwards
- hosts
- intensors
- ipconfig
- masq
- modemwatchdog
- nagios
- perfroutes
- power
- powersupplies
- secrets
- serialconfig
- services
- smtp
- snmp
- sshconfig
- sshforwards
- ssl
- time
- ups
- users

Apply Cancel

- Click **Apply** to run all configurators in the queue.
- Alternately, click **Cancel**. This will discard all the delayed configuration changes.

Note: All queued configuration changes will be lost if Cancel is selected.

To disable the Delayed Configuration Commits mode:

- Uncheck the **Delayed Config Commits** button under **System: Administration** and click **Apply**.
- Click the **Commit Config** button in top right-hand corner of the screen to display the **System: Commit Configuration** screen.
- Click **Apply** to run the **systemsettings** configurator.

System Name: b093-008-2e4u-v Model: B093-008-2E4U-V Firmware: 4.0.0u1
Uptime: 1 days, 2 hours, 16 mins, 53 secs Current User: root

Dashboard Manage Devices Backup Commit Config Log Out

System: Commit Configuration

The following configurators will be run on config commit:

- sshconfig
- systemlog
- systemsettings

Apply Cancel

The Commit Config button will no longer display in the top right-hand corner of the screen and configurations will no longer be queued.

11. System Management

11.6 FIPS Mode

All Tripp Lite console server models use an embedded cryptographic module that has been validated to meet the FIPS 140-2 standards.

Note: The US National Institute of Standards and Technology (NIST) publishes the FIPS (Federal Information Processing Standard) series of standards. FIPS 140-1 and FIPS 140-2 are both technical standards and worldwide de-facto standards for the implementation of cryptographic modules. These standards and guidelines are issued by NIST for use government-wide. NIST develops FIPS when there are compelling Federal government requirements such as for security and interoperability and there are no acceptable industry standards or solutions.

Tripp Lite advance console servers use an embedded OpenSSL cryptographic module that has been validated to meet the FIPS 140-2 standards and has received Certificate #1051.

When configured in FIPS mode, all SSH, HTTPS and SDT Connector access to all services on the advanced console servers will use the embedded FIPS-compliant cryptographic module. To connect, you must also use FIPS-approved cryptographic algorithms found in your browser or client. Otherwise, the connection will fail.

- Select the **System: Administration** menu option.
- Check **FIPS Mode** to enable FIPS mode on boot, then check **Reboot** to safely reboot the console server.

FIPS Mode	<input checked="" type="checkbox"/>	Enable FIPS mode on boot (changing requires safe reboot).
Config Erase	<input type="checkbox"/>	Restore factory default settings (requires safe reboot).
Reboot	<input checked="" type="checkbox"/>	Safely reboot the device.

- Click **Apply**. The console server will now reboot. It will take several minutes to reconnect as secure communications with your browser are validated. When reconnected, it will display “**FIPs mode: Enabled**” in the banner.

Note: To enable FIPS mode from the command line, login and run these commands:

```
config -s config.system.fips=on
touch /etc/config/FIPS
chmod 444 /etc/config/FIPS
flatfsd -b
```

The final command saves to flash and reboots the unit. The unit will take a few minutes to boot into FIPS mode. To disable FIPS mode:

```
config -d config.system.fips
rm /etc/config/FIPS
flatfsd -b
```

12. Status Reports

12.1 Port Access and Active Users

The Administrator can see which Users have access privileges with which serial ports:

- Select **Status: Port Access**.

System Name: b093-008-2e4u-v Model: B093-008-2E4U-V Firmware: 4.0.0u1
Uptime: 1 days, 2 hours, 19 mins, 35 secs Current User: root

Dashboard Manage Devices Backup Log Out

TRIPP-LITE
POWER PROTECTION

Status: Port Access

User	From	Port 1	Port 2	Port 3	Port 4	Port 5	Port 6	Port 7	Port 8	Rear USB 1	Rear USB 2	Rear USB 3	Rear USB 4	GPS
root	Anywhere	Y	Y	Y	Y	Y	Y	Y	Y	Y	Y	Y	Y	Y

Legend
Anywhere Accessible from any IP address.
Anyone No username is required for access.

The Administrator can also see the current status of Users who have active sessions on those ports:

- Select **Status: Active Users**.

Status: Active Users

Active Users at 19:52:23 Jun 02, 2014

Port #	Active Users
1	
2	root
3	
4	tester, root
5	

To disconnect specific users, use the following fields

Users: All users Ports: All ports Disconnect Sessions

With firmware version 3.11 and later, the **Status: Active Users** menu has been extended to enable Administrators to selectively terminate serial sessions. Telnet, SSH, raw TCP and unauthenticated telnet connections can be disconnected. However, you cannot disconnect an RFC2217 session.

The root user or any user in the admin group can access the **Active Users** page, which shows a snapshot of the connected sessions with a timestamp displayed at the top of the page. This page only shows the local console ports, and does not include any cascaded ports.

There are **Disconnect Sessions** buttons along the right hand side of the table listing active users. These buttons disconnect all sessions from the port they correspond to. If the port is not set up in console server mode, the user will see a pop up error informing them that the port needs to be configured in console server mode before they can connect and disconnect.

After the buttons have been pressed, the selected sessions will be disconnected and the number of disconnect sessions will display to the user.

12. Status Reports

To allow more detailed control of which users to disconnect, a table at the bottom of the page with a dropdown menu lists all connected users and connected ports. For example, if you wish to disconnect the user “**tester**” from all ports, choose “**tester**” in the **Users** box, and **All ports** in the Ports box, then hit the **Disconnect Sessions** button.

Note: You can also disconnect serial sessions from the command line using the `--disconnect` option with the `pmusers` command.

12.2 Statistics

The Statistics report provides a snapshot of the status, current traffic and other activities and operations of your console server:

- Select **Status: Statistics**.



System Name: b093-008-2e4u-v Model: B093-008-2E4U-V Firmware: 4.0.0u1
Uptime: 1 days, 2 hours, 23 mins, 28 secs Current User: root



Status: Statistics

- Manage
- Status
 - Port Access
 - Active Users
 - Statistics
 - Support Report
 - Syslog
 - UPS Status
 - RPC Status
 - LLDP/CDP Neighbors
 - Environmental Status
 - Dashboard
- Serial & Network
- Alerts & Logging
- System

Interfaces	Routes/DNS	Serial Ports	IP	ICMP	TCP	UDP	Failover & Out-of-Band	Cellular
eth0	Link encap:Ethernet HWaddr 00:13:C6:01:FA:CB inet addr:10.5.0.128 Bcast:0.0.0.0 Mask:255.255.255.0 inet6 addr: fe80::213:c6ff:fe01:fab/64 Scope:Link UP BROADCAST RUNNING MULTICAST MTU:1500 Metric:1 RX packets:0 errors:0 dropped:79 overruns:0 frame:0 TX packets:22245 errors:0 dropped:0 overruns:0 carrier:0 collisions:0 txqueuelen:532 Interrupt:23							
eth0:0	Link encap:Ethernet HWaddr 00:13:C6:01:FA:CB inet addr:192.168.0.1 Bcast:0.0.0.0 Mask:255.255.255.0 UP BROADCAST RUNNING MULTICAST MTU:1500 Metric:1 Interrupt:23							
eth1	Link encap:Ethernet HWaddr 00:13:C6:01:FA:CC UP BROADCAST MULTICAST MTU:1500 Metric:1 RX packets:0 errors:0 dropped:0 overruns:0 frame:0 TX packets:0 errors:0 dropped:0 overruns:0 carrier:0 collisions:0 txqueuelen:532 Interrupt:24							
lo	Link encap:Local Loopback inet addr:127.0.0.1 Mask:255.0.0.0 inet6 addr: ::1/128 Scope:Host UP LOOPBACK RUNNING MTU:65536 Metric:1							

- Detailed statistics reports can be found by selecting from the various submenus.

12.3 Support Reports

The Support Report provides useful status information that will assist the Tripp Lite technical support team to solve any problems you may experience with your console server.

If you experience a problem and have to contact support, ensure you include the Support Report with your email support request. The Support Report should be generated when the issue is occurring and attached in plain text format.

- Select **Status: Support Report**. You will be presented with a status snapshot.
- Save the file as a text file and attach it to your support email.

Note: For console servers running firmware version 3.11 and above and for devices where the serial number can be retrieved, there is now a Feature Set section in the support report where the serial number is among the information displayed. For devices not supporting this feature, there is no change to the support report.

12. Status Reports

12.4 Syslog

The Linux System Logger in the console server maintains a record of all system messages and errors:

- Select **Status: Syslog**.

The syslog record can be redirected to a remote Syslog Server:

- Enter the remote **Syslog Server Address** and **Syslog Server Port** details. Click **Apply**.

The console maintains a local syslog. To view the local syslog file:

- Select **Status: Syslog**.

System Name: b093-008-2e4u-v Model: B093-008-2E4U-V Firmware: 4.0.0u1
Uptime: 1 days, 2 hours, 24 mins, 25 secs Current User: root

Dashboard Manage Devices Backup Log Out

TRIPP-LITE
POWER PROTECTION

Status: Syslog

Remote System Logging

Syslog Server Address
Specify the address of the remote Syslog Server to use.

Syslog Server Port
Specify which port the remote Syslog Server is serving on.

Local System Logging

Local Log Level

Debug
 Information
 Notice
 Warning
 Error
 Critical
 Alert
 Emergency

This priority and higher log messages will be logged.

Match Pattern
(Currently empty)

A regular expression to match against desired log lines.

```
<14>Jan 1 03:04:58 config[18520]: INFO config - Scheduling: perifroutes  
<14>Jan 1 04:05:00 config[20177]: INFO config - Scheduling: perifroutes  
<14>Jan 1 05:05:01 config[21833]: INFO config - Scheduling: perifroutes
```

To make it easier to find information in the local syslog file, a pattern-matching filter tool is provided.

- Specify the **Match Pattern** to be searched for and click **Apply**. The syslog will then be represented with only those entries that actually include the specified pattern.

12. Status Reports

12.5 Dashboard

The Dashboard provides the Administrator with a summary of the status of the console server and its managed devices. Custom dashboards can be configured for each user group.

12.5.1 Configuring the Dashboard

Only users in the admin group (and the root user) can configure and access the dashboard. To configure a custom dashboard:

- Select **System: Configure Dashboard** and select the user (or group) for whom to configure this custom dashboard layout.



System Name: b093-008-2e4u-v Model: B093-008-2E4U-V Firmware: 4.0.0u1
Uptime: 1 days, 2 hours, 25 mins, 34 secs Current User: root



Note: You can configure a custom dashboard for any admin user or for the admin group, or you can reconfigure the default dashboard

The **Status: Dashboard** screen is the first screen displayed when admin users (other than root) log into the console manager. For example, if you log in as "John" and John is member of the admin group, a dashboard layout will be configured for John that you can view upon log-in and each time you click on the Status: Dashboard menu item.

If there is no dashboard layout configured for John, but an admin group dashboard is configured, you will see the admin group dashboard instead. If there is no user dashboard or admin group dashboard configured, you will see the default dashboard.

The root user does not have its own dashboard.

The above configuration options are intended to enable admin users to set up their own custom dashboards.

The dashboard displays a configurable number of widgets. These widgets include status for major subsystems such as conma, Auto-Response, Managed Devices and cellular. The admin user can configure which widgets are to be displayed and where:

- Go to the **Dashboard layout** panel and select which widget is to be displayed in each of the **Widget Slots**.
- Click **Apply**.



System Name: b093-008-2e4u-v Model: B093-008-2E4U-V Firmware: 4.0.0u1
Uptime: 1 days, 2 hours, 27 mins, 1 secs Current User: root



12. Status Reports

Note: The Alerts widget is a new screen that shows the current alerts status. When an alert is triggered, a corresponding .XML file is created in /var/run/alerts/. The dashboard scans all of these files and displays a summary status in the alerts widget. When an alert is deleted, the corresponding .XML files belonging to that alert are also deleted.

To configure what is to be displayed by each widget:

- Go to the **Configure widgets** panel and configure each selected widget (e.g., specify which UPS status is to be displayed on the ups widget or the maximum number of managed devices to be displayed in the devices widget).
- Click **Apply**.



System Name: b093-008-2e4u-v Model: B093-008-2E4U-V Firmware: 4.0.0u1
Uptime: 1 days, 2 hours, 28 mins, 18 secs Current User: root



System: Configure Dashboard

Dashboard Layout | **Configure Widgets**

Configuring Dashboard for Group: admin

Widget Slot 1 (UPS Status)
No UPSes have been configured

Widget Slot 2 (Auto-Response)

Amount
The number of Auto-Response checks to display

Auto-Response

- Environmental
- Digital I/O Input
- UPS/Power Supply
- UPS Status
- Serial Login/Logout
- Serial Signal
- Serial Pattern
- USB Console Status
- ICMP Ping
- Cellular Data
- Custom Check
- SMS Command
- CLI Session Event
- WebUI Authentication Event
- Network Interface Event
- Routed Data

Note: Dashboard configuration is stored in the /etc/config/config.xml file. Each configured dashboard will increase the config file. If this file gets too big, you can run out of memory space on the console server.

12. Status Reports

12.5.2 Creating Custom Widgets for the Dashboard

To run a custom script inside a dashboard widget:

Create a file called **widget-<name>.sh** in the folder **/etc/config/scripts /** , where <name> can be of your choosing. You can have as many custom dashboard files as desired.

Inside this file, you can use any code you wish. When configuring the dashboard, choose **widget-<name>.sh** in the dropdown list. The dashboard will run the script and display the output of the script commands inside the specific widget.

The best way to format the output is to send HTML commands back to the browser by adding echo commands in the script:

```
echo '<table>'
```

You can run any command and its output will display in the widget window directly.

Below is an example script writing the current date to a file and echoing HTML code back to the browser. The HTML code gets an image from a specific URL and displays it in the widget.

```
#!/bin/sh
date >> /tmp/test
echo '<table>'
echo '<tr><td> This is my custom script running </td></tr>'
```

```
echo '<tr><td>'
echo ''
echo '</td></tr>'
echo '</table>'

exit 0
```

13. Management

The console server has a small number of **Manage** reports and tools available to both Administrators and Users:

- Access and control authorized devices
- View serial port logs and host logs for those devices
- Use SSH or Web Terminal to access serially attached consoles
- Control power devices (where authorized)

All other management console menu items are available to Administrators only.

13.1 Device Management

Note: The manage devices UI has received substantial updates in firmware version 3.12.

To display managed devices and their grouped serial, network and power connections:

- Select **Manage: Devices** or click the **Manage Devices** icon in the top right of the UI.
- Admin-group users are presented with a list of all configured managed devices and their constituent connections. User-group users only see the managed devices where they have been explicitly permitted access.
- The **Status** column displays the current status for each related connection (e.g., active users for serial connections and power status for RPC outlet connections) with links to detailed status.
- The links in the **Actions** column are used to control the managed device (e.g., connect to a console session or power cycle – power actions are not performed until the action has been confirmed via pop-up message).
- The Administrator will be presented with a list of all configured managed devices, whereas the User will only see the managed devices they (or their Group) have been given access privileges for.
- Alternately, select the **Serial** tab for an ungrouped view of permitted serial port connections for the current user.

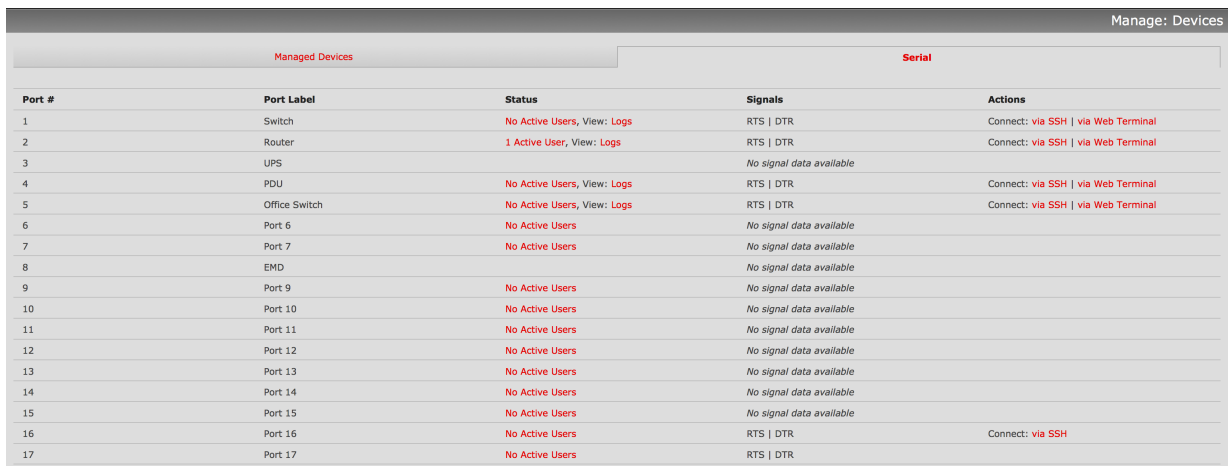

Port #	Port Label	Status	Signals	Actions
1	Switch	No Active Users, View: Logs	RTS DTR	Connect: via SSH via Web Terminal
2	Router	1 Active User, View: Logs	RTS DTR	Connect: via SSH via Web Terminal
3	UPS		No signal data available	
4	PDU	No Active Users, View: Logs	RTS DTR	Connect: via SSH via Web Terminal
5	Office Switch	No Active Users, View: Logs	RTS DTR	Connect: via SSH via Web Terminal
6	Port 6	No Active Users	No signal data available	
7	Port 7	No Active Users	No signal data available	
8	EMD		No signal data available	
9	Port 9	No Active Users	No signal data available	
10	Port 10	No Active Users	No signal data available	
11	Port 11	No Active Users	No signal data available	
12	Port 12	No Active Users	No signal data available	
13	Port 13	No Active Users	No signal data available	
14	Port 14	No Active Users	No signal data available	
15	Port 15	No Active Users	No signal data available	
16	Port 16	No Active Users	RTS DTR	Connect: via SSH
17	Port 17	No Active Users	RTS DTR	

- An additional **Signals** column displays the current state of the serial pins.

Note: To use the Connect: via SSH links, your computer's operating system must recognize the ssh:// URI scheme and have a protocol handler configured (e.g., an SSH client like SecureCRT).

13.2 Port and Host Logs

Administrators and Users can view and download logs of data transferred to and from connected devices.

- Select **Manage: Port Logs** and the serial port number to be displayed.
- To display host logs, select **Manage: Host Logs** and the host to be displayed.

This will display logs stored locally on the console server memory or USB flash memory.

13. Management

13.3 Terminal Connection

There are two methods available for accessing the console server command line and devices attached to the console server serial ports directly from a web browser:

- The web terminal service uses AJAX to enable the web browser to connect to the console server using HTTP or HTTPS as a terminal, without the need for additional client installation on the user's PC.
- The SDT Connector service launches a pre-installed SDT Connector client on the user's PC to establish secure SSH access, then uses pre-installed client software on the client PC to connect to the console server.

Web browser access is available to users who are a member of the admin or users groups.

13.3.1 Web Terminal

The AJAX-based web terminal service may be used to access the console server command line or attached serial devices.

Note: Any communication using the web terminal service with HTTP is unencrypted and not secure. The web terminal connects to the command line or serial device using the same protocol being used to browse the Tripp Lite management console, i.e. if you are browsing using an https:// URL (this is the default), the web terminal connects using HTTPS.

13.3.1.1 Web Terminal to Command Line

To enable the web terminal service for the console server:

- Select **System: Firewall**.
- Check **Enable Web Terminal**, then click **Apply**.

Enable Web Terminal	<input checked="" type="checkbox"/>	Allow web browser access to the system command line shell via <i>Manage -> Terminal</i> .
Alternate Telnet Base	<input type="text"/>	A secondary TCP port range for Telnet access to serial ports. <i>This is in addition to the default port 2000</i>
Alternate SSH Base	<input type="text"/>	A secondary TCP port range for SSH access to serial ports. <i>This is in addition to the default port 3000</i>
Alternate Raw TCP Base	<input type="text"/>	A secondary TCP port range for Raw TCP access to serial ports. <i>This is in addition to the default port 4000</i>
Alternate RFC-2217 Base	<input type="text"/>	A secondary TCP port range for RFC-2217 access to serial ports. <i>This is in addition to the default port 5000</i>
Alternate Unauthenticated Telnet Base	<input type="text"/>	A secondary TCP port range for Unauthenticated Telnet access to serial ports. <i>This is in addition to the default port 6000</i>

Administrators can now communicate directly with the console server command line from their browser:

- Select **Manage: Terminal** to display the web terminal from which you can log in to the console server command line.

The screenshot shows a web browser window with a black header bar on the right that says "Manage: Terminal". On the left, there is a navigation menu under "Serial & Network" with options like "Serial Port", "Users & Groups", "Authentication", "Network Hosts", "Trusted Networks", "IPsec VPN", "OpenVPN", "Call Home", "Cascaded Ports", "UPS Connections", and "RPC Connections". The main area is a terminal window titled "Terminal" with the following text:

```
login: root
Password:
# whoami
root
# cat /etc/version
TrippLite/ACM500x Version 3.3.0 -- Wed Nov 10 13:05:42 EST 2010
#
```

13. Management

13.3.1.2 Web Terminal to Serial Device





To enable the web terminal service for each serial port you want to access:

- Select **Serial & Network: Serial Port** and click **Edit**. Ensure the serial port is in Console Server Mode.
- Check **Web Terminal** and click **Apply**.

Console Server Settings	
Console Server Mode	<input checked="" type="radio"/> Enable remote network access to the console at this serial port.
Logging Level	level 3 - input logging on ports + level 1 Specify the detail of data to log.
Telnet	<input checked="" type="checkbox"/> Enable Telnet access.
SSH	<input checked="" type="checkbox"/> Enable SSH access.
Raw TCP	<input type="checkbox"/> Enable raw TCP access.
RFC 2217	<input type="checkbox"/> Enable RFC 2217 access.
Unauthenticated Telnet	<input type="checkbox"/> Enable Telnet access without requiring the user to provide credentials.
Web Terminal	<input checked="" type="checkbox"/> Enable web browser access via <i>Manage -> Devices -> Serial</i> .

Administrator and Users can communicate directly with serial port attached devices from their browser:

- Select the **Serial** tab on the **Manage: Devices** menu.
- Under the **Action** column, click the **Web Terminal** icon to display the web terminal connected directly to the attached serial device.

Manage: Devices		
Managed Devices		Power
Type	Device	Actions
	Port 1	
	Port 2	
	Port 3	
	Port 4	

Note: The web terminal feature was introduced in firmware version 3.3. Earlier releases had an open source jcterm java terminal applet, which and be downloaded to your browser to connect to the console server and attached serial port devices. However, jcterm is known to have JRE compatibility issues and is no longer supported.

13. Management

13.3.2 SDT Connector Access

Administrator and Users can communicate directly with the console server command line and devices attached to the console server serial ports using SDT Connector and their local tenet client, or using a Web terminal and browser.

- Select **Manage: Terminal**.
- Click **Connect to SDT Connector**. This will activate the SDT Connector client on the computer and load your local telnet client to connect to the command line or serial port using SSH.

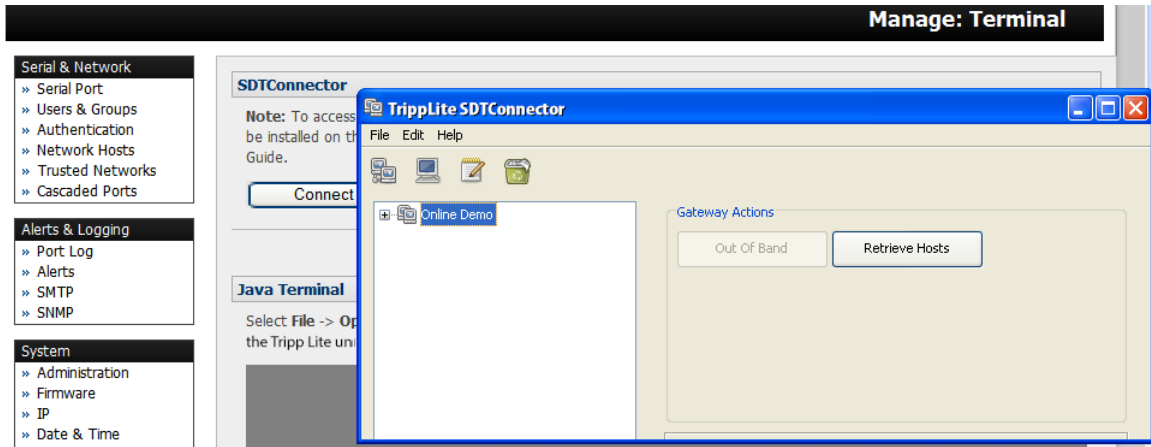

Note: SDT Connector must be installed on the computer you are using. The console server must also be added as a gateway (refer to 6. SSH Tunnels and SDT Connector).

13.4 Power Management

Administrators and Users can access and manage the connected power devices.

- Select **Manage: Power**. This enables the user to power Off/On/Cycle any power outlet on any PDU the user has been given access privileges to (refer to 8. Power, Management and Digital I/O).



System Name: b093-008-2e4u-v Model: B093-008-2E4U-V Firmware: 4.0.0u1
Uptime: 1 days, 2 hours, 37 mins, 59 secs Current User: root

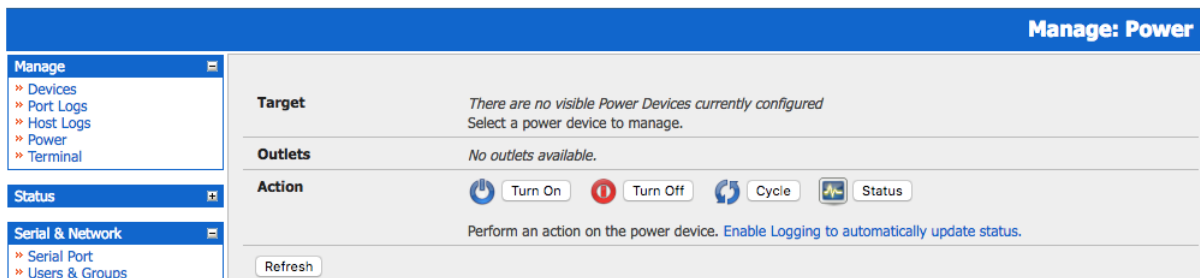

14. Configuration from the Command Line

For those who prefer to configure their console server at the Linux command line level (rather than use a browser and the management console), this chapter describes using command line access and the **config** tool to manage the console server and configure the ports.

When displaying a command, this chapter uses single quotes (') for user defined values (e.g., descriptions and names). Element values without single quotes must be typed exactly as shown.

14.1 Accessing Config from the Command Line

The console server runs a standard Linux kernel and embeds a suite of open source applications. If you do not want to use a browser and the management console tools, you can configure the console server and manage connected devices from the command line using standard Linux and Busybox commands as well as applications like **ifconfig**, **gettyd**, **stty**, **powerman**, **NUT**, etc. However, without careful management, these settings may not withstand a power-cycle-reset or reconfiguration.

Tripp Lite provides a number of custom command line utilities and scripts that easily configure the console server and ensure changes are stored in the console server's flash memory.

The **config** utility allows manipulation of the system configuration from the command line. With config, a new configuration can be activated by running the relevant configurator, which performs the action necessary to make the configuration changes live.

To access **config** from the command line:

- Power up the console server and connect the “terminal” device:
 - If connecting using the serial line, plug a serial cable between the console server's local DB-9 console port and the terminal device. Configure the serial connection of the terminal device you are using to 115200bps, 8 data bits, no parity and one stop bit.
 - If you are connecting over LAN, you will need to interconnect the Ethernet ports and direct your terminal emulator program to the IP address of the console server (192.168.0.1 by default).
- Log on to the console server by pressing return a few times. The console server will request a username and password. Enter the username root and the password default. The command line prompt should appear as a hash (#).



This section is not intended to teach you Linux. In following these instructions, we assume you already have a certain level of understanding before executing Linux kernel level commands.

The config tool

Syntax

```
config [ -ahv ] [ -d id ] [ -g id ] [ -p path ] [ -r configurator ] [ -s id=value ] [ -P id ]
```

Description

The config tool is designed to perform multiple actions from one command so options can be chained together.

The config tool allows manipulation and querying of the system configuration from the command line. Using config, the new configuration can be activated by running the relevant configurator, which performs the necessary action to apply the configuration changes in real-time.

The custom user configuration is saved in the **/etc/config/config.xml** file. This file is transparently accessed and edited when configuring the device using the management console browser GUI. Only the user **'root'** can configure from the shell.

By default, the config elements are separated by a '.' character. The root of the config tree is **<config>**. To address a specific element, place a '.' between each node/branch. To access and display the description of **user1**, type:

```
# config -g config.users.user1.description
```

The root node of the **config** tree is **<config>**. To display the entire **config** tree, type:

```
# config -g config
```

To display the help text for the **config** command, type:

```
# config -h
```

14. Configuration from the Command Line

The **config** application resides in the **/bin** directory. The environmental variable **PATH** contains a route to the **/bin** directory. This allows a user to simply type **config** at the command prompt instead of the full path **/bin/config**.

Options

-a --run-all	Run all registered configurators. This performs every configuration synchronization action pushing all changes to the live system.
-h --help	Display a brief usage message.
-v --verbose	Log extra debug information.
-d --del=id	Remove the given configuration element specified by a '.' separated identifier.
-g --get=id	Display the value of a configuration element.
-p --path=file	Specify an alternate configuration file to use. The default file is located at /etc/config/config.xml .
-r --run=configurator	Run the specified registered configurator. Registered configurators are listed below.
-s --set=id=value	Change the value of configuration element specified by a '.' separated identifier.
-e --export=file	Save active configuration to file.
-i --import=file	Load configuration from file.
-t --test-import=file	Pretend to load configuration from file.
-S --separator=char	The pattern to separate fields with, default is '.'
-P --password=id	Prompt user for a value. Hash the value, and then save.

The registered configurators are:

alerts	ipconfig
auth	nagios
cascade	power
console	serialconfig
dhcp	services
dialin	Secondary
eventlog	systemsettings
hosts	time
ipaccess	ups
	users

There are three ways to delete a config element value. The simplest way is use the delete-node script detailed in **15**.

Advanced Configuration. You can also assign the config element to "", or delete the entire config node using **-d**:

```
# /bin/config -d 'element name'
```

All passwords are saved in plaintext except the user passwords and system passwords, which are encrypted.

Note: The *config* command does not verify whether the nodes edited/added by the user are valid. As such, any node may be added to the tree. For example, if a user were to run the following command:

```
# /bin/config -s config.fruit.apple=sweet
```

the configurator will not verify, though this command is clearly useless. When the configurators are run to turn the *config.xml* file into live config, they will simply ignore this `<fruit>` node. Administrators must make sure of the spelling when typing config commands. Incorrect spelling for a node will not be flagged.

Most configurations made to the XML file will be immediately active. To ensure all configuration changes are active, especially when editing user passwords, run all the configurators:

```
# /bin/config -a
```

For information on backing up and restoring the configuration file, refer to **15. Advanced Configuration**.

14. Configuration from the Command Line

14.1.1 Serial Port Configuration

RS-232 common settings are the first set of configurations to be made to any serial port. For example, to set up serial port 5, use the following properties:

Baud Rate	9600
Parity	None
Data Bits	8
Stop Bits	1
label	Myport
log level	0
protocol	RS232
flow control	None

Use the following commands:

```
# config -s config.ports.port5.speed=9600
# config -s config.ports.port5.parity=None
# config -s config.ports.port5.charsize=8
# config -s config.ports.port5.stop=1
# config -s config.ports.port5.label=myport
# config -s config.ports.port5.loglevel=0
# config -s config.ports.port5.protocol=RS232
# config -s config.ports.port5.flowcontrol=None
```

The following command will synchronize the live system with the new configuration:

```
# config -r serialconfig
```

Note: Supported serial port baud-rates are '50', '75', '110', '134', '150', '200', '300', '600', '1200', '1800', '2400', '4800', '9600', '19200', '38400', '57600', '115200', and '230400'.

Supported parity values are 'None', 'Odd', 'Even', 'Mark' and 'Space'.

Supported data-bits values are '8', '7', '6' and '5'.

Supported stop-bits values are '1', '1.5' and '2'.

Supported flow-control values are 'Hardware', 'Software' and 'None'.

Additionally, before any port can function properly, the port mode needs to be set. Any port can be set to run in one of the five possible modes: [Console Server mode | Device mode | SDT mode | Terminal server mode | Serial bridge mode]. All these modes are mutually exclusive. Refer to **4. Serial Port, Host, Device and User Configuration** for details.

Console Server Mode

The command to set the port in portmanager mode:

```
# config -s config.ports.port5.mode=portmanager
```

To set the following optional config elements for this mode:

Data accumulation period	100 ms
Escape character	% (default is ~)
log level	2 (default is 0)
Shell power command menu	Enabled
RFC2217 access	Enabled
Limit port to 1 connection	Enabled
SSH access	Enabled
TCP access	Enabled
telnet access	Disabled
Unauthorized telnet access	Disabled

```
# config -s config.ports.port5.delay=100
# config -s config.ports.port5.escapechar=%
# config -s config.ports.port5.loglevel=2
# config -s config.ports.port5.powermenu=on
# config -s config.ports.port5.rfc2217=on
# config -s config.ports.port5.singleconn=on
# config -s config.ports.port5.ssh=on
# config -s config.ports.port5.tcp=on
# config -d config.ports.port5.telnet
# config -d config.ports.port5.unauthtel
```

14. Configuration from the Command Line

Device Mode

For a device mode port, set the port type to either **ups**, **rpc**, or **enviro**:

```
# config -s config.ports.port5.device.type=[ups | rpc | enviro]
```

For port 5 as a UPS port:

```
# config -s config.ports.port5.mode=reserved
```

For port 5 as an RPC port:

```
# config -s config.ports.port5.mode=powerman
```

For port 5 as an Environmental port:

```
# config -s config.ports.port5.mode=reserved
```

SDT Mode

To enable access over SSH to a host connected to serial port 5:

```
# config -s config.ports.port5.mode=sdt  
# config -s config.ports.port5.sdt.ssh=on
```

To configure a username and password when accessing this port with Username = user1 and Password = secret:

```
# config -s config.ports.port#.sdt.username=user1  
# config -s config.ports.port#.sdt.password=secret
```

Terminal Server Mode

Enable a TTY login for a local terminal attached to serial port 5:

```
# config -s config.ports.port5.mode=terminal  
# config -s config.ports.port5.terminal=[vt220 | vt102 | vt100 | linux | ansi]
```

The default terminal is vt220.

Serial Bridge Mode

Create a network connection to a remote serial port via RFC-2217 on port 5:

```
# config -s config.ports.port5.mode=bridge
```

Optional configurations for the network address of RFC-2217 server of 192.168.3.3 and TCP port used by the RFC-2217 service = 2500:

```
# config -s config.ports.port5.bridge.address=192.168.3.3  
# config -s config.ports.port5.bridge.port=2500
```

To enable RFC-2217 access: **# config -s config.ports.port5.bridge.rfc2217=on**

To redirect the serial bridge over an SSH tunnel to the server: **# config -s config.ports.port5.bridge.ssh.enabled=on**

14. Configuration from the Command Line

Syslog settings

Additionally, the global system log settings can be set for any specific port, in any mode:

```
# config -s config.ports.port#.syslog.facility='facility'
```

'facility' can be:

- Default
- local 0-7
- auth
- authpriv
- cron
- daemon
- ftp
- kern
- lpr
- mail
- news
- user
- uucp

```
# config -s config.ports.port#.syslog.priority='priority'
```

'priority' can be:

- Default
- warning
- notice
- Info
- error
- emergency
- debug
- critical
- alert

14.1.2 Adding and Removing Users

First, determine the total number of existing Users (if you have no existing Users, you can assume this is 0):

```
# config -g config.users.total
```

This command should display config.users.total 1. If you see config.users.total , this means you have 0 Users configured.

Your new User will be the existing total, plus 1. For example, if the previous command is 0, then start with user number 1. If you already have 1 User, your new User will be number 2, etc.

To add a user (with Username=John, Password=secret and Description=mySecondUser), issue the commands:

```
# config -s config.users.total=2 (assuming we already have 1 user configured)
```

```
# config -s config.users.user2.username=John
```

```
# config -s config.users.user2.description=mySecondUser
```

```
# config -P config.users.user2.password
```

Note: The *-P* parameter will prompt the user for a password and encrypt it. In fact, the value of any config element can be encrypted using the *-P* parameter, but only encrypted user passwords and system passwords are supported. If any other element value were to be encrypted, the value will become inaccessible and have to be reset.

To add this user to specific groups (admin/users):

```
# config -s config.users.user2.groups.group1='groupname'
```

```
# config -s config.users.user2.groups.group2='groupname2'
```

```
etc...
```

To give this user access to a specific port:

```
# config -s config.users.user2.port1=on
```

```
# config -s config.users.user2.port2=on
```

```
# config -s config.users.user2.port5=on
```

```
etc...
```

14. Configuration from the Command Line

To remove port access:

```
# config -s config.users.user2.port1="" (the value is left blank)
```

or simply:

```
# config -d config.users.user2.port1
```

The port number can be anything from 1 to 48, depending on the available ports on the specific console server.

For example, assume we have an RPC device connected to port 1 on the console server and the RPC is configured. To allow this user access to RPC outlet number 3 on the RPC device, run the commands below:

```
# config -s config.ports.port1.power.outlet3.users.user2=John
# config -s config.ports.port1.power.outlet3.users.total=2 (total number of users that have access to this outlet)
```

If more users are allowed access to this power outlet, increment the '**config.ports.port1.power.outlet3.users.total**' element accordingly.

To allow this user access to network host 5 (assuming the host is configured):

```
# config -s config.sdt.hosts.host5.users.user1=John
# config -s config.sdt.hosts.host5.users.total=1 (total number of users having access to host)
```

To allow another user named 'Peter' access to the same host:

```
# config -s config.sdt.hosts.host5.users.user2=Peter
# config -s config.sdt.hosts.host5.users.total=2 (total number of users having access to host)
```

To edit any of the user element values, use the same approach as when adding user elements (i.e. use the '-s' parameter). If any of the config elements do not exist, they will automatically be created.

To delete the user called John, use the delete-node script:

```
# ./delete-node config.users.user2
```

The following command will synchronize the live system with the new configuration:

```
# config -r users
```

14.1.3 Adding and Removing User Groups

The console server is configured with a few default user groups (though only two of these groups are visible in the management console GUI). To determine how many groups are already present:

```
# config -g config.groups.total
```

Assume this value is six. Make sure to number any new groups you create from seven onwards.

To add a custom group to the configuration with Group name=Group7, Group description=MyGroup and Port access= 1,5 , issue the commands:

```
# config -s config.groups.group7.name=Group7
# config -s config.groups.group7.description=MyGroup
# config -s config.groups.total=7
# config -s config.groups.group7.port1=on
# config -s config.groups.group7.port5=on
```

Assume an RPC device is connected to port 1 on the console manager and the RPC is configured. To allow this group access to RPC outlet number 3 on the RPC device, run the two commands below:

```
# config -s config.ports.port1.power.outlet3.groups.group1=Group7
# config -s config.ports.port1.power.outlet3.groups.total=1 (total number of groups that have access to this outlet)
```

If more groups are allowed access to this power outlet, increment the '**config.ports.port1.power.outlet3.groups.total**' element accordingly.

To allow this group access to network host 5:

```
# config -s config.sdt.hosts.host5.groups.group1=Group7
# config -s config.sdt.hosts.host5.groups.total=1 (total number of groups having access to host)
```

14. Configuration from the Command Line

To allow another group named 'Group8' access to the same host:

```
# config -s config.sdt.hosts.host5.groups.group2=Group8
# config -s config.sdt.hosts.host5.groups.total=2 (total number of users having access to host)
```

To delete the Group7, use the following command:

```
# rmuser Group7
```



Attention: The **rmuser** script is a generic script to remove any config element from config.xml correctly. However, any dependencies or references to this group will not be affected. Only the group details are deleted. The administrator is responsible for reviewing **config.xml** and removing group dependencies and references manually, specifically if the group had access to a host or RPC device.

The following command will synchronize the live system with the new configuration:

```
# config -a
```

14.1.4 Authentication

To change the type of authentication for the **console server**:

```
# config -s config.auth.type='authtype'
```

'authtype' can be:

- Local
- LocalTACACS
- TACACS
- TACACSLocal
- TACACSDownLocal
- LocalRADIUS
- RADIUS
- RADIUSLocal
- RADIUSDownLocal
- LocalLDAP
- LDAP
- LDAPLocal
- LDAPDownLocal

To configure TACACS authentication:

```
# config -s config.auth.tacacs.auth_server='comma separated list' (list of remote authentication and authorization servers.)
# config -s config.auth.tacacs.acct_server='comma separated list' (list of remote accounting servers. If unset, Authentication and Authorization Server Address will be used.)
# config -s config.auth.tacacs.password='password'
```

To configure RADIUS authentication:

```
# config -s config.auth.radius.auth_server='comma separated list' (list of remote authentication and authorization servers.)
# config -s config.auth.radius.acct_server='comma separated list' (list of remote accounting servers. If unset, Authentication and Authorization Server Address will be used.)
# config -s config.auth.radius.password='password'
```

To configure LDAP authentication:

```
# config -s config.auth.ldap.server='comma separated list' (list of remote servers.)
# config -s config.auth.ldap.basedn='name' (The distinguished name of the search base. For example: dc=my-company,dc=com)
# config -s config.auth.ldap.binddn='name' (The distinguished name to bind to the server with. The default is to bind anonymously.)
# config -s config.auth.radius.password='password'
```

The following command will synchronize the live system with the new configuration:

```
# config -r auth
```

14. Configuration from the Command Line

14.1.5 Network Hosts

To determine the total number of currently configured hosts:

```
# config -g config.sdt.hosts.total
```

Assume this value is equal to 3. If you add another host, make sure to increment the total number of hosts from 3 to 4:

```
# config -s config.sdt.hosts.total=4
```

If the output is config.sdt.hosts.total , assume 0 hosts are configured.

Add Power Device Host

To add a UPS/RPC network host with the following details:

IP address / DNS name	192.168.2.5
Host name	remoteUPS
Description	UPSroom3
Type	UPS
Allowed services	ssh port 22 and https port 443
Log level for services	0

Issue the commands below:

```
# config -s config.sdt.hosts.host4.address=192.168.2.5
# config -s config.sdt.hosts.host4.name=remoteUPS
# config -s config.sdt.hosts.host4.description=UPSroom3
# config -s config.sdt.hosts.host4.device.type=ups
# config -s config.sdt.hosts.host4.tcpports.tcpport1=22
# config -s config.sdt.hosts.host4.tcpports.tcpport1.loglevel=0
# config -s config.sdt.hosts.host4.udpports.udpport2=443
# config -s config.sdt.hosts.host4.udpports.udpport2.loglevel=0
```

The **loglevel** can have a value of 0 or 1.

The default services that should be configured are: **22/tcp (ssh)**, **23/tcp (telnet)**, **80/tcp (http)**, **443/tcp (https)**, **1494/tcp (ica)**, **3389/tcp (rdp)**, **5900/tcp (vnc)**

Add Other Network Host

To add any other type of network host with the following details:

IP address / DNS name	192.168.3.10
Host name	OfficePC
Description	MyPC
Allowed services	ssh port 22,https port 443
log level for services	1

Issue the commands below. If the host is not a PDU or UPS power device, or a server with IPMI power control, leave the device type blank:

```
# config -s config.sdt.hosts.host4.address=192.168.3.10
# config -s config.sdt.hosts.host4.description=MyPC
# config -s config.sdt.hosts.host4.name=OfficePC
# config -s config.sdt.hosts.host4.device.type="" (leave this value blank)
# config -s config.sdt.hosts.host4.tcpports.tcpport1=22
# config -s config.sdt.hosts.host4.tcpports.tcpport1.loglevel=1
# config -s config.sdt.hosts.host4.udpports.tcpport2=443
# config -s config.sdt.hosts.host4.udpports.tcpport2.loglevel=1
```

To add the new host as a managed device, make sure to use the current total number of managed devices + 1, for the new device number.

To get the current number of managed devices:

```
# config -g config.devices.total
```

14. Configuration from the Command Line

Assuming we already have one managed device, our new device will be device 2. Issue the following commands:

```
# config -s config.devices.device2.connections.connection1.name=192.168.3.10
# config -s config.devices.device2.connections.connection1.type=Host
# config -s config.devices.device2.name=OfficePC
# config -s config.devices.device2.description=MyPC
# config -s config.devices.total=2
```

The following command will synchronize the live system with the new configuration:

```
# config -hosts
```

14.1.6 Trusted Networks

You can further restrict remote access to serial ports based on the source IP address. To configure this via the command line, do the following:

Determine the total number of existing trusted network rules. If you have no existing rules, assume this is 0.

```
# config -g config.portaccess.total
```

This command should display **config.portaccess.total 1**.

If you see **config.portaccess.total**, you have 0 rules configured.

Your new rule will be the existing total, plus 1. For example, if the previous command gave you 0, you start with rule number 1. If you already have rule 1, your new rule will be number 2, etc.

To restrict access to serial port 5 to computers from a single class C network (e.g., 192.168.5.0), issue the following commands (assuming you have a previous rule in place).

Add a trusted network:

```
# config -s config.portaccess.rule2.address=192.168.5.0
# config -s "config.portaccess.rule2.description=foo bar"
# config -s config.portaccess.rule2.netmask=255.255.255.0
# config -s config.portaccess.rule2.port5=on
# config -s config.portaccess.total=2
```

The following command will synchronize the live system with the new configuration:

```
# config -r serialconfig
```

14.1.7 Cascaded Ports

To add a new Secondary device with the following settings:

IP address/DNS name	192.168.0.153
Description	CM in office 42
Label	b098-16
Number of ports	16

The following commands must be issued:

```
# config -s config.cascade.Secondarys.Secondary1.address=192.168.0.153
# config -s "config.cascade.Secondarys.Secondary1.description=B098-16 in office 42"
# config -s config.cascade.Secondarys.Secondary1.label=b098-16
# config -s config.cascade.Secondarys.Secondary1.ports=16
```

The total number of Secondary devices must also be incremented. If this is the first Secondary device being added, type:

```
# config -s config.cascade.Secondarys.total=1
```

Increment this value when adding more Secondary devices.

Note: If a Secondary device is added using the CLI, the Primary SSH public key will need to be manually copied to every Secondary device before cascaded ports will work. Refer to **4. Serial Port, Host, Device and User Configuration**.

The following command will synchronize the live system with the new configuration:

```
# config -r cascade
```

14. Configuration from the Command Line

14.1.8 UPS Connections

Managed UPS Systems

Before adding a managed UPS, make sure at least one port has been configured to run in 'device mode', and that the device is set to 'ups'.

To add a managed UPS with the following values:

Connected via	Port 1
UPS name	My UPS
Description	UPS in room 5
Username to connect to UPS	User2
Password to connect to UPS	secret
Shutdown order	2 (0 shuts down first)
Driver	genericups
Driver option - option	option
Driver option - argument	argument
Logging	Enabled
Log interval	2 minutes
Run script when power is critical	Enabled

```
# config -s config.ups.monitors.monitor1.port=/dev/port01
```

If the port number is higher than 9, eg port 13, enter:

```
# config -s config.ups.monitors.monitor1.port=/dev/port13
# config -s "config.ups.monitors.monitor1.name=My UPS"
# config -s "config.ups.monitors.monitor1.description=UPS in room 5"
# config -s config.ups.monitors.monitor1.username=User2
# config -s config.ups.monitors.monitor1.password=secret
# config -s config.ups.monitors.monitor1.sdorder=2
# config -s config.ups.monitors.monitor1.driver=genericups
# config -s config.ups.monitors.monitor1.options.option1.opt=option
# config -s config.ups.monitors.monitor1.options.option1.arg=argument
# config -s config.ups.monitors.monitor1.options.total=1
# config -s config.ups.monitors.monitor1.log.enabled=on
# config -s config.ups.monitors.monitor1.log.interval=2
# config -s config.ups.monitors.monitor1.script.enabled=on
```

Make sure to increment the total monitors:

```
# config -s config.ups.monitors.total=1
```

The five commands below will add the UPS to 'Managed devices. Assuming there are already two managed devices configured:

```
# config -s "config.devices.device3.connections.connection1.name=My UPS"
# config -s "config.devices.device3.connections.connection1.type=UPS Unit"
# config -s "config.devices.device3.name=My UPS"
# config -s "config.devices.device3.description=UPS in room 5"
# config -s config.devices.total=3
```

To delete this managed UPS:

```
# config -d config.ups.monitors.monitor1
```

Decrement **monitors.total** when deleting a managed UPS

14. Configuration from the Command Line

Remote UPS Systems

To add a remote UPS with the following details (assuming this is your first remote UPS):

```
UPS name                oldUPS
Description             UPS in room 2
Address                192.168.50.50
Log status             Disabled
Log rate              240 seconds
Run shutdown script    Enabled

# config -s config.ups.remotes.remote1.name=oldUPS
# config -s "config.ups.remotes.remote1.description=UPS in room 2"
# config -s config.ups.remotes.remote1.address=192.168.50.50
# config -d config.ups.remotes.remote1.log.enabled
# config -s config.ups.remotes.remote1.log.interval=240
# config -s config.ups.remotes.remote1.script.enabled=on
# config -s config.ups.remotes.total=1
```

The following command will synchronize the live system with the new configuration:

```
# config -a
```

14.1.9 RPC Connections

You can add an RPC connection from the command line, but it is not recommended to do so because of dependency issues.

Before adding an RPC, the management console GUI code ensures at least 1 port has been configured to run in 'device mode', and that the device is set to 'rpc'.

To add an RPC with the following values:

```
RPC type                TL PDUMV20NETLX
Connected via          Port 2
UPS name              MyRPC
Description           RPC in room 5
Login name for device  rpclogin
Login password for device secret
SNMP community        v1 or v2c
Logging              Enabled
Log interval         600 second
Number of power outlets (depends on the type/model of the RPC)

# config -s config.ports.port2.power.type=TL PDUMV20NETLX
# config -s config.ports.port2.power.name=MyRPC
# config -s "config.ports.port2.power.description=RPC in room 5"
# config -s config.ports.port2.power.username=rpclogin
# config -s config.ports.port2.power.password=secret
# config -s config.ports.port2.power.snmp.community=v1
# config -s config.ports.port2.power.log.enabled=on
# config -s config.ports.port2.power.log.interval=600
# config -s config.ports.port2.power.outlets=4
```

The following five commands are used by the management console to add the RPC to 'Managed Devices':

```
# config -s config.devices.device3.connections.connection1.name=myRPC
# config -s "config.devices.device3.connections.connection1.type=RPC Unit"
# config -s config.devices.device3.name=myRPC
# config -s "config.devices.device3.description=RPC in room 5"
# config -s config.devices.total=3
```

The following command will synchronize the live system with the new configuration:

```
# config -a
```

14. Configuration from the Command Line

14.1.10 Environmental

To configure an environmental monitor with the following details:

Monitor name	Envi4
Monitor Description	Monitor in room 5
Temperature offset	2
Humidity offset	5
Enable alarm 1 ?	yes
Alarm 1 label	door alarm
Enable alarm 2 ?	yes
Alarm 2 label	window alarm
Logging enabled ?	yes
Log interval	120 seconds

```
# config -s config.ports.port3.enviro.name=Envi4
# config -s "config.ports.port3.enviro.description=Monitor in room 5"
# config -s config.ports.port3.enviro.offsets.temp=2
# config -s config.ports.port3.enviro.offsets.humid=5
# config -s config.ports.port3.enviro.alarms.alarm1.alarmstate=on
# config -s config.ports.port3.enviro.alarms.alarm1.label=door alarm
# config -s config.ports.port3.enviro.alarms.alarm2.alarmstate=on
# config -s config.ports.port3.enviro.alarms.alarm2.label=window alarm
# config -s config.ports.port3.enviro.alarms.total=2
# config -s config.ports.port3.enviro.log.enabled=on
# config -s config.ports.port3.enviro.log.interval=120
```

It is important to assign `alarms.total=2`, even if they are off.

The following five commands will add the environmental monitor to 'Managed devices':

To get the total number of managed devices:

```
# config -g config.devices.total
```

Make sure to use the total + 1 for the new device below:

```
# config -s config.devices.device5.connections.connection1.name=Envi4
# config -s "config.devices.device5.connections.connection1.type=EMD Unit"
# config -s config.devices.device5.name=Envi4
# config -s "config.devices.device5.description=Monitor in room 5"
# config -s config.devices.total=5
```

The following command will synchronize the live system with the new configuration:

```
# config -a
```

14.1.11 Managed Devices

To add a managed device: (also see UPS, RPC connections and Environmental)

```
# config -s "config.devices.device8.name=my device"
# config -s "config.devices.device8.description=The eighth device"
# config -s "config.devices.device8.connections.connection1.name=my device"
# config -s config.devices.device8.connections.connection1.type=[serial | Host | UPS | RPC]
# config -s config.devices.total=8 (decrement this value when deleting a managed device)
```

To delete the above managed device:

```
# config -d config.devices.device8
```

The following command will synchronize the live system with the new configuration:

```
# config -a
```

14. Configuration from the Command Line

14.1.12 Port Log

To configure serial/network port logging:

```
# config -s config.eventlog.server.address='remote server ip address'  
# config -s config.eventlog.server.logfacility='facility'
```

'facility' can be:

- Daemon
- Local 0-7
- Authentication
- Kernel
- User
- Syslog
- Mail
- News
- UUCP

```
# config -s config.eventlog.server.logpriority='priority'
```

'priority' can be:

- Info
- Alert
- Critical
- Debug
- Emergency
- Error
- Notice
- Warning

Assume the remote log server needs a username 'name1' and password 'secret':

```
# config -s config.eventlog.server.username=name1  
# config -s config.eventlog.server.password=secret
```

To set the remote path as '/tripp-lite/logs' to save logged data:

```
# config -s config.eventlog.server.path=/ tripp-lite/logs  
# config -s config.eventlog.server.type=[none | syslog | nfs | cifs | usb]
```

If the server type is set to usb, none of the other values need to be set. The mount point for storing on a remote USB device is **/var/run/portmanager/logdir**

The following command will synchronize the live system with the new configuration:

```
# config -a
```

14.1.13 Alerts

You can add an email, SNMP or NAGIOS alert by following the steps below.

General Settings for All Alerts

Assume this is our second alert, and we want to send alert emails to john@triplite.com and SMS text messages to peter@triplite.com:

```
# config -s config.alerts.alert2.description=MySecondAlert  
# config -s config.alerts.alert2.email=john@ triplite.com  
# config -s config.alerts.alert2.email2=peter@ triplite.com
```

To use NAGIOS to notify of this alert:

```
# config -s config.alerts.alert2.nasca.enabled=on
```

To use SNMP to notify of this alert:

```
# config -s config.alerts.alert2.snmp.enabled=on
```

Increment the total alerts:

```
# config -s config.alerts.total=2
```

14. Configuration from the Command Line

Below are the specific settings, depending on the type of alert required:

Connection Alert

To trigger an alert when a user connects to serial port 5 or network host 3:

```
# config -s config.alerts.alert2.host3='host name'
# config -s config.alerts.alert2.port5=on
# config -s config.alerts.alert2.sensor=temp
# config -s config.alerts.alert2.signal=DSR
# config -s config.alerts.alert2.type=login
```

Signal Alert

To trigger an alert when a signal changes state on port 1:

```
# config -s config.alerts.alert2.port1=on
# config -s config.alerts.alert2.sensor=temp
# config -s config.alerts.alert2.signal=[ DSR | DCD | CTS ]
# config -s config.alerts.alert2.type=signal
```

Pattern Match Alert

To trigger an alert if the regular expression `.*0.0% id` is found in serial port 10's character stream:

```
# config -s "config.alerts.alert2.pattern=.*0.0% id"
# config -s config.alerts.alert2.port10=on
# config -s config.alerts.alert2.sensor=temp
# config -s config.alerts.alert2.signal=DSR
# config -s config.alerts.alert2.type=pattern
```

UPS Power Status Alert

To trigger an alert when **myUPS** (on localhost) or **thatUPS** (on remote host 192.168.0.50) power status changes between on-line, on-battery and low battery:

```
# config -s config.alerts.alert2.sensor=temp
# config -s config.alerts.alert2.signal=DSR
# config -s config.alerts.alert2.type=ups
# config -s config.alerts.alert2.ups1=myUPS@localhost
# config -s config.alerts.alert2.ups2=thatUPS@192.168.0.50
```

Environmental and Power Sensor Alert

```
# config -s config.alerts.alert2.enviro.high.critical='critical value'
# config -s config.alerts.alert2.enviro.high.warning='warning value'
# config -s config.alerts.alert2.enviro.hysteresis='value'
# config -s config.alerts.alert2.enviro.low.critical='critical value'
# config -s config.alerts.alert2.enviro.low.warning='warning value'
# config -s config.alerts.alert2.enviro1='Enviro sensor name'
# config -s config.alerts.alert2.outlet#='RPCname'.outlet#
'alert2.outlet#' increments sequentially with each added outlet. The second 'outlet#' refers to the specific RPC power outlets.
# config -s config.alerts.alert2.rpc#='RPC name'
# config -s config.alerts.alert2.sensor=[ temp | humid | load | charge]
# config -s config.alerts.alert2.signal=DSR
# config -s config.alerts.alert2.type=enviro
# config -s config.alerts.alert2.ups1='UPSname@hostname'
```

Example 1: To configure a temperature sensor alert for a sensor called 'SensorInRoom42':

```
# config -s config.alerts.alert2.sensor=temp
# config -s config.alerts.alert2.enviro.high.critical=60
# config -s config.alerts.alert2.enviro.high.warning=50
# config -s config.alerts.alert2.enviro.hysteresis=2
# config -s config.alerts.alert2.enviro.low.critical=5
# config -s config.alerts.alert2.enviro.low.warning=10
# config -s config.alerts.alert2.enviro1=SensorInRoom42
# config -s config.alerts.alert2.signal=DSR
# config -s config.alerts.alert2.type=enviro
```

14. Configuration from the Command Line

Example 2: To configure a load sensor alert for outlets 2 and 4 for an RPC called 'RPCInRoom20':

```
# config -s config.alerts.alert2.outlet1='RPCname'.outlet2
# config -s config.alerts.alert2.outlet2='RPCname'.outlet4
# config -s config.alerts.alert2.enviro.high.critical=300
# config -s config.alerts.alert2.enviro.high.warning=280
# config -s config.alerts.alert2.enviro.hysteresis=20
# config -s config.alerts.alert2.enviro.low.critical=50
# config -s config.alerts.alert2.enviro.low.warning=70
# config -s config.alerts.alert2.rpc1=RPCInRoom20
# config -s config.alerts.alert2.sensor=load
# config -s config.alerts.alert2.signal=DSR
# config -s config.alerts.alert2.type=enviro
```

Alarm Sensor Alert

To set an alert for 'doorAlarm' and 'windowAlarm', which are two alarms connected to an environmental sensor called 'SensorInRoom3'. Both alarms are disabled on Mondays from 8:15 am to 2:30 pm:

```
# config -s config.alerts.alert2.alarm1=SensorInRoom3.alarm1 (doorAlarm)
# config -s config.alerts.alert2.alarm1=SensorInRoom3.alarm2 (windowAlarm)
# config -s config.alerts.alert2.alarange.mon.from.hour=8
# config -s config.alerts.alert2.alarange.mon.from.min=15
# config -s config.alerts.alert2.alarange.mon.until.hour=14
# config -s config.alerts.alert2.alarange.mon.until.min=30
# config -s config.alerts.alert2.description='description'
# config -s config.alerts.alert2.sensor=temp
# config -s config.alerts.alert2.signal=DSR
# config -s config.alerts.alert2.type=alarm
```

To enable an alarm for the entire day:

```
# config -s config.alerts.alert2.alarange.mon.from.hour=0
# config -s config.alerts.alert2.alarange.mon.from.min=0
# config -s config.alerts.alert2.alarange.mon.until.hour=0
# config -s config.alerts.alert2.alarange.mon.until.min=0
```

The following command will synchronize the live system with the new configuration:

```
# config -r alerts
```

14.1.14 SMTP and SMS

To set up an SMTP mail or SMS server with the following details:

Outgoing server address	mail.tripplite.com
Secure connection type	SSL
Sender	john@tripplite.com
Server username	john
Server password	secret
Subject line	SMTP alerts

```
# config -s config.system.smtp.server=mail.tripplite.com
# config -s config.system.smtp.encryption=SSL (can also be TLS or None )
# config -s config.system.smtp.sender=john@tripplite.com
# config -s config.system.smtp.username=john
# config -s config.system.smtp.password=secret
# config -s config.system.smtp.subject=SMTP alerts
```

To set up an SMTP SMS server with the same details as above:

```
# config -s config.system.smtp.server2=mail.tripplite.com
# config -s config.system.smtp.encryption2=SSL (can also be TLS or None )
# config -s config.system.smtp.sender2=john@tripplite.com
# config -s config.system.smtp.username2=john
# config -s config.system.smtp.password2=secret
# config -s config.system.smtp.subject2=SMTP alerts
```

14. Configuration from the Command Line

The following command will synchronize the live system with the new configuration:

```
# config -a
```

14.1.15 SNMP

To set up the SNMP agent on the device:

```
# config -s config.system.snmp.protocol=[ UDP | TCP ]
# config -s config.system.snmp.trapport='port number' (default is 162)
# config -s config.system.snmp.address='NMS IP network address'
# config -s config.system.snmp.community='community name' (v1 and v2c only)
# config -s config.system.snmp.engineid='ID' (v3 only)
# config -s config.system.snmp.username='username' (v3 only)
# config -s config.system.snmp.password='password' (v3 only)
# config -s config.system.snmp.version=[ 1 | 2c | 3 ]
```

The following command will synchronize the live system with the new configuration:

```
# config -a
```

14.1.16 Administration

To change the administration settings to:

```
System Name          og.mydomain.com
System Password (root account)  secret
Description          Device in office 2
```

```
# config -s config.system.name=og.mydomain.com
# config -P config.users.user1.password (will prompt user for a password)
# config -s "config.system.location=Device in office 2"
```

Note: The `-P` parameter will prompt the user for a password and encrypt it. The value of any config element can be encrypted using the `-P` parameter, but only encrypted user passwords and system passwords are supported. If any other element value were to be encrypted, the value will become inaccessible and must be reset.

An alternative to the second command above is:

```
# /etc/scripts/user-mod -P root
```

The following command will synchronize the live system with the new configuration:

```
# config -a
```

14.1.17 IP Settings

To configure the primary network interface with static settings:

```
IP address          192.168.0.23
Netmask             255.255.255.0
Default gateway     192.168.0.1
DNS server 1       192.168.0.1
DNS server 2       192.168.0.2
```

```
# config -s config.interfaces.wan.address=192.168.0.23
# config -s config.interfaces.wan.netmask=255.255.255.0
# config -s config.interfaces.wan.gateway=192.168.0.1
# config -s config.interfaces.wan.dns1=192.168.0.1
# config -s config.interfaces.wan.dns2=192.168.0.2
# config -s config.interfaces.wan.mode=static
# config -s config.interfaces.wan.media=[ Auto | 100baseTx-FD | 100baseTx-HD | 10baseT-HD ] 10baseT-FD
```

To enable bridging between all interfaces:

```
# config -s config.system.bridge.enabled=on
```

To enable IPv6 for all interfaces:

```
# config -s config.system.ipv6.enabled=on
```

14. Configuration from the Command Line

To configure the management LAN interface, use the same commands as above but replace:

```
config.interfaces.wan, with config.interfaces.lan
```

To enable the management LAN interface, run the following command:

```
config -d config.interfaces.lan.disabled  
config -r ipconfig
```

Note: *Not all devices have a management LAN interface.*

To configure a failover device in case of an outage:

```
# config -s config.interfaces.wan.failover.address1='ip address'  
# config -s config.interfaces.wan.failover.address2='ip address'  
# config -s config.interfaces.wan.failover.interface=[ eth1 | console | modem ]
```

The network interfaces can also be configured automatically:

```
# config -s config.interfaces.wan.mode=dhcp  
# config -s config.interfaces.lan.mode=dhcp
```

The following command will synchronize the live system with the new configuration:

```
# /bin/config --run=ipconfig
```

The following command will synchronize the live system with the new configuration:

```
# config -r ipconfig
```

14.1.18 Date and Time Settings

To enable NTP using a server at pool.ntp.org, issue the following commands:

```
# config -s config.ntp.enabled=on  
# config -s config.ntp.server=pool.ntp.org
```

Alternately, you can manually change the clock settings:

To change running system time:

```
# date 092216452005.05          Format is MMDDhhmm[[CC]YY][.ss]
```

The following command will save this new system time to the hardware clock:

```
# /bin/hwclock --systohc
```

Alternately, to change the hardware clock:

```
# /bin/hwclock --set --date=092216452005.05  Format is MMDDhhmm[[CC]YY][.ss]
```

The following command will save this new hardware clock time as the system time:

```
# /bin/hwclock --hctosys
```

To change the timezone:

```
# config -s config.system.timezone=US/Eastern
```

The following command will synchronize the live system with the new configuration:

```
# config -r time
```

14. Configuration from the Command Line

14.1.19 Dial-In Settings

To enable dial-in access on the DB9 serial port from the command line with the following attributes:

Local IP Address	172.24.1.1
Remote IP Address	172.24.1.2
Authentication Type:	MSCHAPv2
Serial Port Baud Rate:	115200
Serial Port Flow Control:	Hardware
Custom Modem Initialization:	ATQ0V1H0
Callback phone	0800223665
User to dial as	user1
Password for user	secret

Run the following commands:

```
# config -s config.console.ppp.localip=172.24.1.1
# config -s config.console.ppp.remoteip=172.24.1.2
# config -s config.console.ppp.auth=MSCHAPv2
# config -s config.console.speed=115200
# config -s config.console.flow=Hardware
# config -s config.console.initstring=ATQ0V1H0
# config -s config.console.ppp.enabled=on
# config -s config.console.ppp.callback.enabled=on
# config -s config.console.ppp.callback.phone1=0800223665
# config -s config.console.ppp.username=user1
# config -s config.console.ppp.password=secret
```

To make the dialed connection the default route:

```
# config -s config.console.ppp.defaultroute=on
```

Please note that supported authentication types are 'None', 'PAP', 'CHAP' and 'MSCHAPv2'.

Supported serial port baud-rates are '9600', '19200', '38400', '57600', '115200', and '230400'.

Supported parity values are 'None', 'Odd', 'Even', 'Mark' and 'Space'.

Supported data-bits values are '8', '7', '6' and '5'.

Supported stop-bits values are '1', '1.5' and '2'.

Supported flow-control values are 'Hardware', 'Software' and 'None'.

If you do not wish to use out-of-band dial-in access, please note the procedure for enabling start-up messages on the console port is covered in section **15. Advanced Configuration**.

The following command will synchronize the live system with the new configuration:

```
# config -a
```

14.1.20 DHCP Server

To enable the DHCP server on the console management LAN with settings:

Default lease time	200000 seconds
Maximum lease time	300000 seconds
DNS server1	192.168.2.3
DNS server2	192.168.2.4
Domain name	company.com
Default gateway	192.168.0.1
IP pool 1 start address	192.168.0.20
IP pool 1 end address	192.168.0.100
Reserved IP address	192.168.0.50
MAC to reserve IP for	00:1e:67:82:72:d9
Name to identify this host	John-PC

14. Configuration from the Command Line

Issue the commands:

```
# config -s config.interfaces.lan.dhcpd.enabled=on
# config -s config.interfaces.lan.dhcpd.defaultlease=200000
# config -s config.interfaces.lan.dhcpd.maxlease=300000
# config -s config.interfaces.lan.dhcpd.dns1=192.168.2.3
# config -s config.interfaces.lan.dhcpd.dns2=192.168.2.4
# config -s config.interfaces.lan.dhcpd.domain=company.com
# config -s config.interfaces.lan.dhcpd.gateway=192.168.0.1
# config -s config.interfaces.lan.dhcpd.pools.pool1.start=192.168.0.20
# config -s config.interfaces.lan.dhcpd.pools.pool1.end=192.168.0.100
# config -s config.interfaces.lan.dhcpd.pools.total=1
# config -s config.interfaces.lan.dhcpd.staticips.staticip1.ip=192.168.0.50
# config -s config.interfaces.lan.dhcpd.staticips.staticip1.mac=00:1e:67:82:72:d9
# config -s config.interfaces.lan.dhcpd.staticips.staticip1.host=John-PC
# config -s config.interfaces.lan.dhcpd.staticips.total=1
```

The following command will synchronize the live system with the new configuration:

```
# config -a
```

14.1.21 Services

You can manually enable or disable network servers from the command line. For example, to guarantee the following server configuration:

HTTP Server	Enabled
HTTPS Server	Disabled
Telnet Server	Disabled
SSH Server	Enabled
SNMP Server	Disabled
Ping Replies (Respond to ICMP echo requests)	Disabled
TFTP server	Enabled

```
# config -s config.services.http.enabled=on
# config -d config.services.https.enabled
# config -d config.services.telnet.enabled
# config -s config.services.ssh.enabled=on
# config -d config.services.snmp.enabled
# config -d config.services.pingreply.enabled
# config -s config.services.tftp.enabled=on
```

To set secondary port ranges for any service:

# config -s config.services.telnet.portbase='port base number'	Default: 2000
# config -s config.services.ssh.portbase='port base number'	Default: 3000
# config -s config.services.tcp.portbase='port base number'	Default: 4000
# config -s config.services.rfc2217.portbase='port base number'	Default: 5000
# config -s config.services.unauthtel.portbase='port base number'	Default: 6000

The following command will synchronize the live system with the new configuration:

```
# config -a
```

14. Configuration from the Command Line

14.1.22 NAGIOS

To configure NAGIOS with the following settings:

```
NAGIOS host name      b098-16 (Name of this system)
NAGIOS host address   192.168.0.1 (IP to find this device at)
NAGIOS server address 192.168.0.10 (upstream NAGIOS server)
Enable SDT for NAGIOS ext. Enabled
SDT gateway address   192.168.0.1 (defaults to host address)
Prefer NRPE over NSCA Disabled (defaults to Disabled)

# config -s config.system.nagios.enabled=on
# config -s config.system.nagios.name=b098-16
# config -s config.system.nagios.address=192.168.0.1
# config -s config.system.nagios.server.address=192.168.0.10
# config -s config.system.nagios.sdt.disabled=on (disables SDT for nagios extensions)
# config -s config.system.nagios.sdt.address=192.168.0.1
# config -s config.system.nagios.nrpe.prefer=""
```

To configure NRPE with following settings:

```
NRPE port             5600 (port to listen on for nrpe. Defaults to 5666)
NRPE user             user1 (User to run as. Defaults to nrpe)
NRPE group            group1 (Group to run as. Defaults to nobody)
Allow command arguments Enabled

# config -s config.system.nagios.nrpe.enabled=on
# config -s config.system.nagios.nrpe.port=5600
# config -s config.system.nagios.user=user1
# config -s config.system.nagios.nrpe.group=group1
# config -s config.system.nagios.nrpe.cmdargs=on
```

To configure NSCA with the following settings:

```
NSCA encryption      BLOWFISH (can be: [ None | XOR | DES | TRIPLEDES | CAST-256 | BLOWFISH |
                  TWOFISH | RIJNDAEL-256 | SERPENT | GOST ])
NSCA password        secret
NSCA check-in interval 5 minutes
NSCA port            5650 (defaults to 5667)
user to run as       User1 (defaults to nsca)
group to run as      Group1 (defaults to nobody)

# config -s config.system.nagios.nsca.enabled=on
# config -s config.system.nagios.nsca.encryption=BLOWFISH
# config -s config.system.nagios.nsca.secret=secret
# config -s config.system.nagios.nsca.interval=2
# config -s config.system.nagios.nsca.port=5650
# config -s config.system.nagios.nsca.user=User1
# config -s config.system.nagios.nsca.group=Group1
```

The following command will synchronize the live system with the new configuration:

```
# config -a
```

15. Advanced Configuration

Tripp Lite console servers run the embedded Linux operating system. As such, administrator users can configure the console server and monitor, and manage attached serial console and host devices from the command line using Linux commands and the config utility (as described in 14. Configuration from the Command Line).

The Linux kernel in the console server also supports GNU bash shell script enabling the Administrator to run custom scripts. This chapter presents a number of useful scripts and scripting tools including:

- delete-node, a general script for deleting users, groups, hosts, UPS systems, etc.
- ping-detect, which will run specified commands when a specific host stops responding to ping requests.

15.1 Custom Scripting

The console server supports GNU **bash** shell commands (refer to **Appendix A**), enabling the Administrator to run custom scripts.

15.1.1 Custom Script to Run when Booting

The `/etc/config/rc.local` script runs whenever the system boots. By default, this script file is empty. You can add any commands to this file if you want them to be run at boot time. For example, if you wanted to display **hello world**:

```
#!/bin/sh
echo "Hello World!"
```

If this script has been copied from a Windows computer, you may need to run the following command on the script before **bash** can run it successfully:

```
# dos2unix /etc/config/rc.local
```

Another scenario would be to call another custom script from the `/etc/config/rc.local` file, ensuring your custom script will run whenever the system is booted.

15.1.2 Running Custom Scripts when Alerts are Triggered

Whenever an alert is triggered, specific scripts are called. These scripts all reside in `/etc/scripts/`. Below is a list of the default scripts that run for each applicable alert:

- For a connection alert (when a user connects or disconnects from a port or network host): `/etc/scripts/portmanager-user-alert` (for port connections) or `/etc/scripts/sdt-user-alert` (for host connections).
- For a signal alert (when a signal on a port changes state): `/etc/scripts/portmanager-signal-alert` .
- For a pattern match alert (when a specific regular expression is found in the serial ports character stream): `/etc/scripts/portmanager-pattern-alert` .
- For a UPS status alert (when the UPS power status changes between on line, on battery, and low battery): `/etc/scripts/ups-status-alert` .
- For an environmental, power and alarm sensor alerts (temperature, humidity, power load and battery charge alerts): `/etc/scripts/environmental-alert` .
- For an interface failover alert: `/etc/scripts/interface-failover-alert` .

All of these scripts perform a check to determine whether you have created a custom script to run. The code that performs this check is shown below (an extract from the file `/etc/scripts/portmanager-pattern-alert`):

```
# If there's a user-configured script, run it instead
scripts[0]="/etc/config/scripts/pattern-alert.${ALERT_PORTNAME}"
scripts[1]="/etc/config/scripts/portmanager-pattern-alert"
for (( i=0 ; i < ${#scripts[@]} ; i++ )); do
    if [ -f "${scripts[$i]}" ]; then
        exec /bin/sh "${scripts[$i]}"
    fi
done
```

15. Advanced Configuration

This code shows there are two alternative scripts that can be run instead of the default script. This code first checks whether a file “`/etc/config/scripts/pattern-alert.${ALERT_PORTNAME}`” exists. The variable `${ALERT_PORTNAME}` must be replaced with “port01” or “port13”, or whichever port the alert should run. If this file cannot be found, the script checks whether the file “`/etc/config/scripts/portmanager-pattern-alert`” exists. If either of these files exist, the script calls the `exec` command on the first file that it finds and runs that custom file/script instead.

For example, you can copy the `/etc/scripts/portmanager-pattern-alert` script file to `/etc/config/scripts/portmanager-pattern-alert`:

```
# cd /
# mkdir /etc/config/scripts (if the directory does not already exist)
# cp /etc/scripts/portmanager-pattern-alert /etc/config/scripts/portmanager-pattern-alert
```

The next step is to edit the new script file. Open the file `/etc/config/scripts/portmanager-pattern-alert` using `vi` (or any other editor), and remove the lines that check for a custom script (the code from above). This will prevent the new custom script from repeatedly calling itself. After these lines have been removed, edit the file or add any additional scripting to the file.

15.1.3 Sample Script - Power Cycling on Pattern Match

For example, if an RPC (PDU) is connected to port 1 on a console server and some telecommunications device connected to port 2, which is powered by the RPC outlet 3. Assuming the telecom device transmits a character stream “EMERGENCY” out on its serial console port every time that it encounters some specific error, the only way to fix this error is to power cycle the telecom device.

The first step is to set up a pattern-match alert on port 2 to check for the pattern “EMERGENCY”.

Next, we need to create a custom script for this alert:

```
# cd /
# mkdir /etc/config/scripts (if the directory does not already exist)
# cp /etc/scripts/portmanager-pattern-alert /etc/config/scripts/portmanager-pattern-alert
```

Note: To prevent an infinite loop, make sure to remove the `if` statement (which checks for a custom script) from the new script.

The `pmppower` utility is used to send power commands to an RPC device in order to power cycle the telecom device:

```
# pmppower -l port01 -o 3 cycle (The RPC is on serial port 1. The telecom device is powered by RPC outlet 3)
```

Now append this command to our custom script. This will guarantee the telecom device will be power cycled every time the console reads the “EMERGENCY” character stream on port 2.

15.1.4 Sample Script - Multiple Email Notifications on Each Alert

If you desire to send more than one email when an alert triggers, you have to create a replacement script using the method described above and add the appropriate lines to your new script.

Currently, there is a script `/etc/scripts/alert-email` that runs from within all the alert scripts (e.g., `portmanager-user-alert` or `environmental-alert`). The alert-email script is responsible for sending the email. The line that invokes the email script appears as follows:

```
/bin/sh /etc/scripts/alert-email $suffix &
```

If you wish to send another email to a single address or the same email to many recipients, edit the custom script appropriately. You can follow the examples in any of the seven alert scripts listed above. In particular, consider the `portmanager-user-alert` script. If you need to send the same alert email to more than one email address, find the lines in the script responsible for invoking the alert-email script, then add the following lines below the existing lines:

```
export TOADDR="emailaddress@domain.com"
/bin/sh /etc/scripts/alert-email $suffix &
```

These two lines assign a new email address to `TOADDR` and invoke the alert-email script in the background.

15. Advanced Configuration

15.1.5 Deleting Configuration Values from the CLI

The **delete-node** script is provided to help with deleting nodes from the command line. The “**delete-node**” script takes one argument: the node name you want to delete (e.g., “**config.users.user1**” or “**config.sdt.hosts.host1**”).

Delete-node is a general script for deleting any node you desire (users, groups, hosts, UPS systems, etc.) from the command line. The script deletes the specified node and shuffles the remainder of the node values.

For example, if there are five users configured and we use the script to delete user 3, then user 4 will become user 3, user 5 will become user 4, and so on.

This creates a complication, as this script does NOT check for any other dependencies that the node being deleted may have had. You are responsible for making sure any references and dependencies connected to the deleted node are removed or corrected in the config.xml file.

The script treats all nodes the same. The syntax to run the script is **# ./delete-node {node name}** . To remove user 3:

```
# ./delete-node config.users.user3
```

The delete-node script

```
#!/bin/bash
#User must provide the node to be removed. e.g. "config.users.user1"
# Usage: delete-node {full node path}

if [ $# != 1 ]
then
    echo "Wrong number of arguments"
    echo "Usage: delnode {full '.' delimited node path}"
    exit 2
fi

# test for spaces
TEMP=`echo "$1" | sed 's/.*/N/'`
if [ "$TEMP" = "N" ]
then
    echo "Wrong input format"
    echo "Usage: delnode {full '.' delimited node path}"
    exit 2
fi

# testing if node exists
TEMP=`config -g config | grep "$1"`
if [ -z "$TEMP" ]
then
    echo "Node $1 not found"
    exit 0
fi

# LASTFIELD is the last field in the node path e.g. "user1"
# ROOTNODE is the upper level of the node e.g. "config.users"
# NUMBER is the integer value extracted from LASTFIELD e.g. "1"
# TOTALNODE is the node name for the total e.g. "config.users.total"
# TOTAL is the value of the total number of items before deleting e.g. "3"
# NEWTOTAL is the modified total i.e. TOTAL-1
# CHECKTOTAL checks if TOTAL is the actual total items in .xml

LASTFIELD=${1##*.}
ROOTNODE=${1%.*}
NUMBER=`echo $LASTFIELD | sed 's/^[a-zA-Z]*//g'`
TOTALNODE=`echo ${1%.*} | sed 's/\(.*\)1.total/'`
TOTAL=`config -g $TOTALNODE | sed 's/.*/'`
NEWTOTAL=$(( $TOTAL - 1 )
```

15. Advanced Configuration

```
# Make backup copy of config file
cp /etc/config/config.xml /etc/config/config.bak
echo "backup of /etc/config/config.xml saved in /etc/config/config.bak"

if [ -z $NUMBER ] # test whether a singular node is being \
#deleted e.g. config.sdt.hosts
then

    echo "deleting $1"
    config -d "$1"

    echo Done
    exit 0

elif [ $NUMBER = $TOTAL ] # Test if only one item exists
then
    echo "only one item exists"
    # Deleting node
    echo "Deleting $1"
    config -d "$1"

    # Modifying item total.
    config -s "$TOTALNODE=0"

    echo Done
    exit 0

elif [ $NUMBER -lt $TOTAL ] # more than one item exists
then

    # Modify the users list so user numbers are sequential
    # by shifting the users into the gap one at a time...

    echo "Deleting $1"

    LASTFIELDTEXT=`echo $LASTFIELD | sed 's/[0-9]//g'`
    CHECKTOTAL=`config -g $ROOTNODE.$LASTFIELDTEXT$TOTAL`

    if [ -z "$CHECKTOTAL" ]
    then
        echo "WARNING: "$TOTALNODE" greater than number of items"
    fi

    COUNTER=1
    while [ $COUNTER != $((TOTAL-NUMBER+1)) ]
    do

        config -g $ROOTNODE.$LASTFIELDTEXT$((NUMBER+COUNTER)) \
        | while read LINE
        do
            config -s \
            "`echo "$LINE" | sed -e "s/$LASTFIELDTEXT$((NUMBER+ \
            COUNTER))/$LASTFIELDTEXT$((NUMBER+COUNTER-1))/"`" \
            -e 's / /=/'`"

        done

        let COUNTER++
    done

    # deleting last user
    config -d $ROOTNODE.$LASTFIELDTEXT$TOTAL
```

15. Advanced Configuration

```
# Modifying item total.
config -s "$TOTALNODE=$NEWTOTAL"

echo Done
exit 0
else
echo "error: item being deleted has an index greater than total items. Increase the total count variable."
exit 0
fi
```

15.1.6 Power Cycle Any Device upon a Ping Request Failure

The ping-detect script is designed to run specified commands when a monitored host stops responding to ping requests.

The first parameter taken by the **ping-detect** script is the hostname / IP address of the device to ping. Any other parameters are regarded as a command to run whenever the ping to the host fails. Ping-detect can run any number of commands.

Below is an example using ping-detect to power cycle an RPC (PDU) outlet whenever a specific host fails to respond to a ping request. The ping-detect is run from **/etc/config/rc.local** to ensure the monitoring starts whenever the system boots.

Assuming a serially-controlled RPC is connected to port01 on a console server and a router is powered by outlet 3 on the RPC (and the router has an internal IP address of 192.168.22.2), the following instructions will show you how to continuously ping the router. When the router fails to respond to a series of pings, the console server will send a command to RPC outlet 3 to power cycle the router and write the current date/time to a file:

- Copy the ping-detect script to **/etc/config/scripts /** on the console server.
- Open **/etc/config/rc.local** using vi.
- Add the following line to **rc.local**:

```
/etc/config/scripts/ping-detect 192.168.22.2 /bin/bash -c "pmpower -l port01 -o 3 cycle && date" > /tmp/output.log &
```

The above command will cause the ping-detect script to continuously ping the host at 192.168.22.2 (i.e. the router). If the router crashes, it will no longer respond to ping requests. If this happens, the two commands **pmpower** and **date** will run. The output from these commands is sent to file **/tmp/output.log** to maintain a record. The ping-detect is also run in the background using the **"&"**.

Remember the **rc.local** script is only run by default when the system boots. You can manually run the rc.local script or the ping-detect script, if desired.

Ping-Detect Script

The above is just one example of using the ping-detect script. The concept behind the script is to run any number of commands when a specific host stops responding to ping requests. Here are details of the **ping-detect** script itself:

```
#!/bin/sh
# Usage: ping-detect HOST [COMMANDS...]
# This script takes 2 types of arguments: hostname/IPaddress to ping, and the commands to
# run if the ping fails 5 times in a row. This script can only take one host/IPaddress per
# instance. Multiple independent commands can be sent to the script. The commands will be
# run one after the other.
#
# PINGREP is the entire reply from the ping command
# LOSS is the percentage loss from the ping command
# $1 must be the hostname/IPaddress of device to ping
# $2... must be the commands to run when the pings fail.
COUNTER=0
TARGET="$1"
shift
# loop indefinitely:
while true
do
# ping the device 10 times
PINGREP=`ping -c 10 -i 1 "$TARGET" `
#get the packet loss percentage
LOSS=`echo "$PINGREP" | grep "%" | sed -e 's/.*\[[0-9]*\]%.*\1/'`
```

15. Advanced Configuration

```
if [ "$LOSS" -eq "100" ]
then
    COUNTER=`expr $COUNTER + 1`
else
    COUNTER=0
    sleep 30s
fi
if [ "$COUNTER" -eq 5 ]
then
    COUNTER=0
    "$@"
    sleep 2s
fi
done
```

15.1.7 Running Custom Scripts when a Configurator is Invoked

A configurator is responsible for reading the values in **/etc/config/config.xml** and making the appropriate changes live. Some changes made by the configurators are part of the Linux configuration, such as user passwords or **ipconfig**.

There are currently nineteen configurators, with each responsible for a specific config group (e.g., the **"users"** configurator makes the user configurations in the **config.xml** file live). To see all the available configurators, type the following in a command line prompt:

```
# config
```

When a change is made using the management console web GUI, the appropriate configurator is automatically run. This can be problematic; if another user/administrator makes a change using the management console, the configurator could possibly overwrite any custom CLI/linux configurations you may have set.

The solution to such a situation is to create a custom script that runs after each configurator has run. After each configurator runs, it will check whether that appropriate custom script exists. You can then add any commands to the custom script that will be invoked after the configurator runs.

The custom scripts must be in the correct location:

```
/etc/config/scripts/config-post-
```

To create an alerts custom script:

```
# cd /etc/config/scripts
# touch config-post-alerts
# vi config-post-alerts
```

This script could be used to recover a specific backup config, overwrite a config, make copies of config files, etc.

15.1.8 Backing-Up the Configuration and Restoring Using a Local USB Drive

The **/etc/scripts/backup-usb** script has been written to save and load custom configuration using a USB flash drive. Before saving the configuration locally, you must prepare the USB storage device for use. To do this, disconnect all USB storage devices, except for the storage device you wish to use.

Usage: **/etc/scripts/backup-usb** COMMAND [FILE]

COMMAND:

```
check-magic -- check volume label
set-magic -- set volume label
save [FILE] -- save configuration to USB
delete [FILE] -- delete a configuration tarball from USB
list -- list available config backups on USB
load [FILE] -- load a specific config from USB
load-default -- load the default configuration
set-default [FILE] -- set which file becomes the default
```

15. Advanced Configuration

First, check if the USB disk has a label:

```
# /etc/scripts/backup-usb check-magic
```

If this command returns “Magic volume not found”, run the following command:

```
# /etc/scripts/backup-usb set-magic
```

To save the configuration:

```
# /etc/scripts/backup-usb save config-20May
```

To check if the backup was saved correctly:

```
# /etc/scripts/backup-usb list
```

If this command does not display “* **config-20May**”, there was an error saving the configuration.

The `set-default` command takes an input file as an argument and renames it to “default.opg”. This default configuration remains stored on the USB disk. The next time you want to load the default config, it will be sourced from the new default.opg file. To set a config file as the default:

```
# /etc/scripts/backup-usb set-default config-20May
```

To load this default:

```
# /etc/scripts/backup-usb load-default
```

To load any other config file:

```
# /etc/scripts/backup-usb load {filename}
```

The **/etc/scripts/backup-usb** script can be executed directly with various COMMANDS or called from other custom scripts you may create. However, it is recommended you do not customize the **/etc/scripts/backup-usb** script itself.

15.1.9 Backing Up the Configuration Off-Box

If you do not have a USB on your console server, you can back up the configuration to an off-box file. Before backing up, you need to arrange a method to transfer the backup off-box. This could be via an NFS share, a Samba (Windows) share to USB storage or copied off-box via the network. If backing up directly to off-box storage, make sure it is mounted.

/tmp is not a good location for the backup, except as a temporary location before transferring it off-box. The **/tmp** directory will not survive a reboot. The **/etc/config** directory is not a good place either, as it will not survive a restore.

Backup and restore should be done by the root user to ensure correct file permissions are set. The `config` command is used to create a backup tarball:

```
config -e <Output File>
```

The tarball will be saved to the indicated location. It will contain the contents of the **/etc/config** / directory in an uncompressed and unencrypted form.

Example nfs storage:

```
# mount -t nfs 192.168.0.2:/backups /mnt # config -e /mnt/b098.config  
# umount/mnt/
```

Example transfer off-box via scp:

```
# config -e /tmp/b098.config  
# scp /tmp/b098.config username@192.168.0.2:/backups
```

The `config` command is also used to restore a backup:

```
config -i <Input File>
```

This will extract the contents of the previously created backup to **/tmp**, and then synchronize the **/etc/config** directory with the copy in **/tmp**.

One problem that may arise is a lack of space in **/tmp** to extract files to. The following command will temporarily increase the size of **/tmp**:

```
mount -t tmpfs -o remount,size=2048k tmpfs /var
```

15. Advanced Configuration

If restoring to a new unit or one that has been factory defaulted, it is important to make sure the process generating SSH keys is either stopped or completed before restoring configuration. If this is not done, then a mix of old and new keys may be put in place.

As SSH uses these keys to avoid man-in-the-middle attacks, logging in may be disrupted.

15.2 Advanced Portmanager

Tripp Lite's **portmanager** program manages the console server serial ports. It routes network connection to serial ports, checks permissions, and monitors and logs all the data flowing to/from the ports.

15.2.1 Portmanager Commands

pmshell

The **pmshell** command acts similar to the standard **tip** or **cu** commands, but all serial port access is directed via the portmanager.

Example: To connect to port 8 via the portmanager:

```
# pmshell -l port08
```

pmshell Commands:

Once connected, the pmshell command supports a subset of the '~' escape commands that tip/cu support. For SSH you must prefix the escape with an additional '~' command (i.e. use the '~~' escape).

Send Break: Typing the character sequence '~b' will generate a BREAK on the serial port (if you are doing this over SSH, you will need to type '~~b')

History: Typing the character sequence '~h' will generate a history on the serial port.

Quit pmshell: Typing the character sequence '~.' will exit from pmshell.

Set RTS to 1 run the command: **pmshell --rts=1**

Show all signals: **# pmshell -signals**

```
3DSR=1 DTR=1 CTS=1 RTS=1 DCD=0
```

Read a line of text from the serial port: **# pmshell -getline**

Notes: Firmware version 3.5.2 and later includes pmshell escape command so you can now hit ~m from a connected serial port to drop back to pmshell.

For console servers running firmware version 3.11.0 and above, **pmshell** has a set of built-in key sequences to access the power menu, return to the serial port selection menu, and so on. Extra controls (key sequences) can be added to the built-in key sequences and configured per serial port. All ports can behave the same or selectively add control sequences. The controls can be different from port to port for the same function.

For example, you could configure pmshell so that when you are using serial port 2, pressing **Ctrl+p** would take you straight to the power menu for that port.

The **pmshell** control commands are configured only via the command line.

A helper script configures a control command on a range of serial ports to eliminate the cumbersome task of entering the configuration command for every port. You will still need to use this script once per control function (see below). There are only six control functions.

pmshell control functions and their built in key sequences:

~b - Generate BREAK - send a break to the console.

~h - View history - see the traffic logs for the port (must have port logging enabled).

~p - Power menu - open the power menu for the port (port must be configured for an RPC).

~m - Connect to port menu - go back to the serial port selection menu.

~. - Exit pmshell - exit pmshell completely.

~? - Show help message - shows the help message.

15. Advanced Configuration

Per port control command config parameters:

- config.ports.portX.ctrlcode.break** - Generate BREAK.
- config.ports.portX.ctrlcode.portlog** - View History.
- config.ports.portX.ctrlcode.power** - Power menu.
- config.ports.portX.ctrlcode.chooser** - Connect to port menu.
- config.ports.portX.ctrlcode.quit** - Exit pmshell.
- config.ports.portX.ctrlcode.help** - Show help message.

The **pmshell** help message is NOT updated with the extra control command keys that may be configured. As an example, to configure **Ctrl+p** to open the power menu when using serial port 3, enter the following in the console server's command shell:

```
config -s config.ports.port3.ctrlcode.power=16  
killall -HUP portmanager
```

The first command sets the power menu command to listen for Ctrl+p, where decimal 16 is the character code sent when you press Ctrl+p in the serial port session (see the range of control codes below). The second command (killall -HUP portmanager) tells portmanager to reload the configuration so the new control code will take effect. Rebooting the device will also work.

There is a script to set serial control codes on a range of ports so that bulk port configuration can be performed more easily. For example, to set the power menu control code to Ctrl+p (keycode 16) on ports 4 to 10 inclusive, enter the following at the command line:

```
/etc/scripts/set-serial-control-codes 4 10 power 16
```

This sets the power menu control key to Ctrl+p (see the range of control codes below).

Note: *If nothing has been configured on a particular serial port in the included range, configuration for that port will be skipped.*

Control Codes (Ctrl+a=1 ... Ctrl+z=26):

```
Ctrl+a = 1  
Ctrl+b = 2  
Ctrl+c = 3  
Ctrl+d = 4  
Ctrl+e = 5  
Ctrl+f = 6  
Ctrl+g = 7  
Ctrl+h = 8  
Ctrl+i = 9  
Ctrl+j = 10  
Ctrl+k = 11  
Ctrl+l = 12  
Ctrl+m = 13  
Ctrl+n = 14  
Ctrl+o = 15  
Ctrl+p = 16  
Ctrl+q = 17  
Ctrl+r = 18  
Ctrl+s = 19  
Ctrl+t = 20  
Ctrl+u = 21  
Ctrl+v = 22  
Ctrl+w = 23  
Ctrl+x = 24  
Ctrl+y = 25  
Ctrl+z = 26
```

15. Advanced Configuration

pmchat

The **pmchat** command acts similar to the standard chat command, but all serial port access is directed via the portmanager.

For example, to run a chat script via the portmanager:

```
# pmchat -v -f /etc/config/scripts/port08.chat < /dev/port08
```

For more information on using chat (and pmchat), consult the UNIX manual pages:

<http://techpubs.sgi.com/library/tpl/cgibin/getdoc.cgi?coll=linux&db=man&fname=/usr/share/catman/man8/chat.8.html>

pmusers

The **pmusers** command is used to query the portmanager for active user sessions.

For example, to detect which users are currently active on which serial ports:

```
# pmusers
```

This command will output nothing if there are no active users currently connected to any ports. Otherwise, it will respond with a sorted list of usernames per active port:

```
Port 1:
  user1
  user2
Port 2:
  user1
Port 8:
  user2
```

The above output indicates a user named **“user1”** is actively connected to ports 1 and 2, while **“user2”** is connected to both ports 1 and 8

With firmware version 3.11 and later, the pmusers command is extended with the **--disconnect** option, which allows an admin user or root to disconnect console server sessions from the command line. The following connection types can be disconnected:

```
telnet
SSH
Raw TCP
Unauth'ed Telnet
```

You cannot disconnect an **RFC2217** session.

If the **--disconnect** option is specified, the pmusers command goes into disconnect mode, where you can specify the users with **-u**, the ports with **-l** (by label) or **-n** (by name).

By default, the command will prompt the user before actually disconnecting the matching sessions. This can be overridden with the **--no-prompt** argument.

Example: **pmuser** sessions:

```
# pmusers --disconnect
Disconnect all users from all ports? (y/n)
y
5 sessions were disconnected

# pmusers --disconnect -u robertw
Disconnect user robertw from all ports? (y/n)
y
1 session was disconnected

# pmusers --disconnect -u robertw -n 5
Disconnect user robertw from port 5 (BranchRouter01)? (y/n)
y
No sessions were disconnected

# pmusers --disconnect -n 5
Disconnect all users from port 5 (BranchRouter01)? (y/n)
y
2 sessions were disconnected
```

15. Advanced Configuration

```
# pmusers --disconnect -u robertw -u pchunt -n 4 -n 6
Disconnect users robertw, pchunt from ports 4, 6? (y/n)
y
10 sessions were disconnected
```

```
# pmusers --disconnect -u tester --no-prompt
No sessions were disconnected
```

portmanager daemon

There is normally no need to stop and restart the daemon. To restart the daemon normally, simply run the command:

```
# portmanager
```

Supported command line options are:

Force portmanager to run in the foreground: **--nodaemon**

Set the level of debug logging: **--loglevel={debug,info,warn,error,alert}**

Change which configuration file it uses: **-c /etc/config/portmanager.conf**

Signals

Sending a SIGHUP signal to the portmanager will cause it to reread its configuration file.

15.2.2 External Scripts and Alerts

The portmanager has the ability to execute external scripts on certain events.

When a port is opened by the portmanager:

- It attempts to execute **/etc/config/scripts/portXX.init** (where XX is the number of the port, e.g. 08). The script is run with STDIN and STDOUT, both connected to the serial port.
- If the script cannot be executed, portmanager will execute **/etc/config/scripts/portXX.chat** via the chat command on the serial port.

When an alert occurs on a port:

- When an alert occurs on a port, the portmanager will attempt to execute **/etc/config/scripts/portXX.alert** (where XX is the port number, e.g. 08).
- The script is run with STDIN containing the data that triggered the alert, and STDOUT redirected to **/dev/null**, NOT to the serial port. If you wish to communicate with the port, use **pmshell** or **pmchat** from within the script.
- If the script cannot be executed, the alert will be mailed to the address configured in the system administration section.

When a user connects to any port:

- If a file called **/etc/config/pmshell-start.sh** exists, it will run when a user connects to a port. It provides two arguments: the "Port number" and the "Username". For example:

```
</etc/config/pmshell-start.sh >
#!/bin/sh
PORT="$1"
USER="$2"
echo "Welcome to port $PORT $USER"
< /etc/config/pmshell-start.sh >
```

- The return value from the script controls whether the user is accepted or not, if 0 is returned (or nothing is done on exit as in the above script) the user is permitted, otherwise the user is denied access.

15. Advanced Configuration

- Here is a more complex script which reads from configuration to display the port label if available and denies access to the root user:

```
</etc/config/pmsHELL-start.sh>
#!/bin/sh
PORT="$1"
USER="$2"
LABEL=$(config -g config.ports.port$PORT.label | cut -f2- -d' ')
if [ "$USER" == "root" ]; then
echo "Permission denied for Super User"
exit 1
fi
if [ -z "$LABEL" ]; then
echo "Welcome $USER, you are connected to Port $PORT"
else
echo "Welcome $USER, you are connected to Port $PORT ($LABEL)"
fi
</etc/config/pmsHELL-start.sh>
```

15.3 Raw Access to Serial Ports

15.3.1 Access to Serial Ports

You can use **tip** and **stty** to completely bypass the portmanager and have raw access to the serial ports.

When you run tip on a portmanager-controlled port, portmanager closes that port and stops monitoring it until tip releases control.

With stty, the changes made to the port only "stick" until that port is closed and opened again. It is unlikely stty will be used for anything other than initial debugging of the serial connection.

If you want to use stty to configure the port, you can put stty commands in **/etc/config/scripts/portXX.init** which runs whenever portmanager opens the port.

Otherwise, any setup you use with stty will get lost when the portmanager opens the port. The reason portmanager resets back to its config rather than using what is on the port is so the port is in a good state and will work, no matter what things are done to the serial port outside of portmanager.

15.3.2 Accessing the Console/Modem Port

The console dial-in is handled by **mgetty**, with automatic PPP login extensions. mgetty is a smart getty replacement, designed to be used with Hayes-compatible data and data/fax modems. mgetty knows about modem initialization, manual modem answering (so your modem does not answer if the machine is not ready), UUCP locking (so you can use the same device for dial-in and dial-out). mgetty provides extensive logging facilities. All standard mgetty options are supported.

Modem initialization strings:

- To override the standard modem initialization string either use the Management Console (refer to **5. Firewall, Failover and OOB Access**) or the command line config tool (refer to **14. Configuration from the Command Line**).

Enabling boot messages on the console:

- If you are not using a modem on the DB9 console port and instead wish to connect to it directly via Null Modem cable, you may want to enable verbose mode. Verbose mode allows you to see the standard linux start-up messages. This can be achieved with the following commands:

```
# /bin/config --set=config.console.debug=on # /bin/config --run=console # reboot
```

- If at some point in the future you chose to connect a modem for dial-in out-of-band access, the procedure can be reversed with the following commands:

```
# /bin/config --del=config.console.debug # /bin/config --run=console # reboot
```

15. Advanced Configuration

15.4 IP Filtering

The console server uses the iptables utility to provide a stateful firewall of LAN traffic. By default, rules are automatically inserted to allow access to enabled services and serial port access via enabled protocols. The commands that add these rules are contained in configuration files:

```
/etc/config/fw.rules
```

This is an executable shell script that runs whenever the LAN interface is brought up. Modifications are made to the iptables configuration because of CGI actions or the config command line tool.

The basic steps are as follows:

- Running iptables configuration is erased; per-interface and other standard system chains are installed.
- Fall through Block rules (default deny) are installed.
- **Serial & Network:** Services policies are installed in per-interface chains.
- **Custom Serial & Network:** Firewall rules are inserted at the top of the rule sets, taking priority over any other configuration.

If you require further firewall customization, extra rules can be persisted by creating a file at `/etc/config/scripts/firewall-post` containing iptables commands to amend the firewall policy.

Documentation about using the iptables command can be found at the Linux netfilter website <http://netfilter.org/documentation/index.html>. Many tutorials are also available at the netfilter website, in particular, the tutorials listed on the netfilter how-to page.

15.5 SNMP Status Reporting

All console servers contain an SNMP Service (**snmpd**) which provides on-demand status information. **snmpd** is an SNMP agent that binds to a port and awaits requests from SNMP management software. Upon receiving a request, it processes the request(s), collects the requested information and/or performs the requested operation(s) and returns the information to the sender.

Note: Initially, only advanced console server models were equipped with an SNMP Service. With firmware version 3.0 (and later), this support was extended to all console servers. Also, the MIBS were extended (and renamed for compliance) with this firmware release.

All console servers can also be configured to send SNMP traps/messages to multiple remote SNMP Network Managers on defined trigger events. Refer to **7. Alerts, Auto-Response and Logging** for configuration details

15.5.1 Retrieving Status Information using SNMP

Console servers can provide serial and device status information via SNMP. This includes:

- Serial port status
- Active users
- Remote Power Control (RPC) and Power Distribution Unit (PDU) status
- Environmental Monitoring Device (EMD) status
- Signal alert status
- Environmental alert status
- UPS alert status

The MIBs in your console server are located in `/etc/snmp/mibs`.

TL-STATUS-MIB.mib – This new MIB contains serial and connected device status information (for `snmpstatusd` & `snmpalrtd`).

TL-STATUSv2-MIB.mib – This new MIB contains extended status and alert.

TL-SMI-MIB.mib – Enterprise structure of management information.

TLTRAP-MIB.mib – SMIv1 traps from old MIBS (as `smilint` will not let SMIv1 structures coexist with SMIv2).

15. Advanced Configuration

15.5.2 Check Firewall Rules

Select **System: Services**. Ensure the **SNMP daemon** box has been checked for the interface required. This will allow SNMP requests through the firewall for the specified interface.

15.5.3 Enable SNMP Service

The console server supports different versions of SNMP, including SNMPv1, SNMPv2c and SNMPv3.

SNMP, although an industry standard, brings with it a variety of security concerns. For example, SNMPv1 and SNMPv2c offer no inherent privacy, while SNMPv3 is susceptible to man-in-the-middle attacks. Recent IETF developments suggests tunnelling SNMP over widely accepted technologies such as SSH (Secure Shell) or TLS (Transport Layer Security), rather than relying on a less mature security systems such as SNMPv3's USM (User-based Security Model).

Additional information regarding SNMP security issues and SNMPv3 can be found at:

<http://net-snmp.sourceforge.net/wiki/index.php/TUT:Security>

<http://www.ietf.org/html.charters/snmpv3-charter.html>.

- Select **Alerts & Logging: SNMP**.



System Name: b093-008-2e4u-v Model: B093-008-2E4U-V Firmware: 4.0.0u1
Uptime: 1 days, 2 hours, 40 mins, 22 secs Current User: root



Alerts & Logging: SNMP

Manage Status Serial & Network Alerts & Logging <ul style="list-style-type: none">Port LogAuto-ResponseSMTP & SMSSNMP System <ul style="list-style-type: none">AdministrationSSL CertificatesConfiguration BackupFirmwareIPDate & TimeDialFirewallServicesDHCP ServerNagiosConfigure DashboardDigital I/O	SNMP Service Details	Primary SNMP Manager	Secondary SNMP Manager	
	Enable	<input type="checkbox"/>	Enable the SNMP service	
	TCP/IP Protocol	UDP	The TCP/IP protocol to serve.	
	Location	(Currently empty)	System Location	
	Contact		System Contact	
	SNMP v1 & v2c			
	Read-Only Community	(Currently empty)	The read-only community.	
	Read-Write Community	(Currently empty)	The read-write community.	
	SNMP v3			
	Engine ID		Override the automatically generated SNMPv3 Engine ID. Note: If not specified, an Engine ID will be automatically generated using Network Interface details.	

- The **SNMP Service Details** tab is shown by default. The SNMP Service Details tab controls aspects of the SNMP Service, including Security Level. It manages requests from external agents for Tripp Lite status information.
- Check the **Enable the SNMP Service** box to start the SNMP Service. The service is disabled by default.
- Select either **UDP** or **TCP** for the TCP/IP Protocol. UDP is the recommended protocol and selected by default. TCP should only be used in special cases, such as when Port Forwarding SNMP requests/responses to or from the Tripp Lite device is required.
- Complete the **Location** and **Contact** fields. The Location field should describe the physical location of the Tripp Lite device and will be used in response to requests for the SNMPv2-MIB::sysLocation.0 of the device. The Contact field refers to the person responsible for the Tripp Lite device (i.e. System Administrator). This will be used in response to request SNMPv2-MIB::sysContact.0.

15. Advanced Configuration

- Enter the **Read-Only Community** and **Read-Write Community**. **This is required for SNMP v1 & v2c only.** The Read-Only Community field is used to specify the SNMPv1 or SNMPv2c community allowed read-only (GET and GETNEXT) access. This must be specified in order for both versions to become enabled. The Read-Write Community field is used to specify the SNMPv1 or SNMPv2c community allowed read-write (GET, GETNEXT and SET) access.
- Configure **SNMP v3**, if required. SNMP v3 provides secure SNMP operations with USM (User-based Security Model). It offers various levels of security, including user-based authentication and basic encryption.
 - o The Engine ID is used to localize the SNMPv3 user. It will automatically generate from a network interface (eth0) hardware address if left blank, or must be entered as a hex value (e.g., 0x01020304).
 - o Specify the **Security Level**:
 - noauth** No authentication or encryption is required. This is the minimum level of security.
 - auth** Authentication is required but encryption is not enforced. An authentication protocol (SHA or MD5) and password are required.
 - priv** Enforces the use of encryption. This is the highest level of security and requires an encryption protocol (DES or AES) and password, in addition to the authentication protocol and password.
 - o Complete the **Read Only Username**. Enter the read-only security name. This field is mandatory and must be completed when configuring the console server for SNMPv3.
 - o For a **Security Level** of **auth**, select the **Auth. Protocol (SHA or MD5)** and the **Auth. Password**. A password of at least 8 characters is required.
 - o For a **Security Level** of **priv**, select the **Privacy Protocol (DES or AES)** and the **Privacy Password**. **AES** is recommended, as it provides stronger privacy but requires more intense calculations. A password of at least 8 characters is required.
- Click **Apply**.

The screenshot shows the 'SNMP v3' configuration page in the Tripp Lite Management Console. The page is titled 'the read-write community.' and contains the following fields and options:

- Engine ID:** A text input field with a note: 'Override the automatically generated SNMPv3 Engine ID. *Optional.*'
- Security Level:** Three radio button options: noauth, auth, and priv. A note below reads: 'The SNMPv3 Security Level. *'priv' is recommended for enforcing both authentication and encryption.*'
- Read Only Username:** A text input field with a note: 'The SNMPv3 read-only security name. *Mandatory for SNMPv3.*'
- Auth. Protocol:** A dropdown menu set to 'SHA'. A note below reads: 'The SNMPv3 authentication protocol.'
- Auth. Password:** A text input field with a note: 'The SNMPv3 users authentication password.'
- Confirm Password:** A text input field with a note: 'Confirm the SNMPv3 users authentication password.'
- Privacy Protocol:** A dropdown menu set to 'DES'. A note below reads: 'The SNMPv3 privacy protocol.'
- Privacy Password:** A text input field with a note: 'The SNMPv3 encryption password.'
- Confirm Password:** A text input field with a note: 'Confirm the SNMPv3 encryption password.'

An 'Apply' button is located at the bottom of the configuration area.

- Set up serial ports and devices per operational requirements, such as UPS, RPC/PDU and EMD.

15. Advanced Configuration

- Copy the MIBs from /etc/snmp/mibs on the Tripp Lite product to a local directory using **scp** or **Winscp**. For example:
`scp root@b098:/etc/snmp/mibs/*`

- Using the **snmpwalk** and **snmpget** commands, the status information can be retrieved from any console server. For example:

```
snmpwalk -Oa -v1 -M ./usr/share/snmp/mibs -c public b098 TL-STATUS-MIB::tlStatus
snmpget -Oa -v1 -M ./usr/share/snmp/mibs -c public b098 TL-STATUSMIB::
tlSerialPortStatusSpeed.2
```

noauth

```
snmpwalk -Oa -v3 -l noAuthNoPriv -u readonlyusername -M ./usr/share/snmp/mibs b098 TL-STATUS-MIB::tlStatus
```

auth

```
snmpwalk -Oa -v3 -l authNoPriv -u readonlyusername -a SHA -A "authpassword" -M ./usr/share/snmp/mibs b098 TL-STATUS-
MIB::tlStatus
```

priv

```
snmpwalk -Oa -v3 -l authNoPriv -u readonlyusername -a SHA -A "authpassword" -x DES -X "privpassword" -M ./usr/share/snmp/mibs
b098 TL-STATUS-MIB::tlStatus
```

```
-l Security Level
-u Security Name or Read Only Username
-a Authentication Protocol – SHA or MD5
-A Authentication Password
-x Privacy Protocol – DES or AES
-X Privacy Password
```

A MIB browser may be used to explore the Tripp Lite enterprise MIB structure.

15.5.4 Adding Multiple Remote SNMP Managers

You can add multiple SNMP servers for alert traps and the first and second SNMP servers using the management console (refer to **7. Alerts, Auto-Response and Logging**) or the command line config tool. Further SNMP servers must be added manually using config.

Log in to the console server's command line shell as root or an admin user. Refer to the management console UI or user documentation for descriptions of each field.

To set the SNMP Manager Address field:

```
config --set="config.system.snmp.address3=w.x.y.z"
```

.. replacing w.x.y.z with the IP address or DNS name.

To set the Manager Trap Port field:

```
config --set="config.system.snmp.trapport3=162"
```

.. replacing 162 with the TCP/UDP port number.

To set the SNMP Manager Protocol field:

```
config --set="config.system.snmp.protocol3=UDP" or
```

```
config --set="config.system.snmp.protocol3=TCP"
```

To set the SNMP Manager Version field:

```
config --set="config.system.snmp.version3=3"
```

To set the SNMP Manager v1 & v2c community field:

```
config --set="config.system.snmp.community3=public"
```

To set the SNMP Manager v3 Engine ID field:

```
config --set="config.system.snmp.engineid3=0x8000000001020304"
```

.. replacing 0x8000000001020304 with the hex Engine-ID

15. Advanced Configuration

To set the SNMP Manager v3 Security Level field:

```
config --set="config.system.snmp.seclvl3=noAuthNoPriv" or
config --set="config.system.snmp.seclvl3=authNoPriv" or
config --set="config.system.snmp.seclvl3=authPriv"
```

To set the SNMP Manager v3 Username field:

```
config --set="config.system.snmp.username3=username"
```

To set the SNMP Manager v3 Auth. Protocol and password fields:

```
config --set="config.system.snmp.authprotocol3=SHA" or
config --set="config.system.snmp.authprotocol3=MD5"
config --set="config.system.snmp.authpassword3=password 1"
```

To set the SNMP Manager v3 Privacy Protocol and password fields:

```
config --set="config.system.snmp.privprotocol3=AES" or
config --set="config.system.snmp.privprotocol3=DES"
config --set="config.system.snmp.privpassword3=password 2"
```

Once the fields are set, apply the configuration with the following command:

```
config --run snmp
```

You can add a third or more SNMP servers by incrementing the "2" in the above commands (e.g., `config.system.snmp.protocol3`, `config.system.snmp.address3`, etc.).

15.6 Secure Shell (SSH) Public Key Authentication

This section covers the generation of public and private keys in a Linux and Windows environment and configuring SSH for public key authentication. The steps to use in a clustering environment are:

- Generate a new public and private key pair.
- Upload the keys to the primary device and to each secondary console server.
- Fingerprint each connection to validate.

15.6.1 SSH Overview

Popular TCP/IP applications such as telnet, rlogin, ftp and others transmit their passwords unencrypted. Doing this across public networks like the Internet can have catastrophic consequences, as it allows an opening for eavesdropping, connection hijacking, and other network-level attacks.

Secure Shell (SSH) is a program used to log into another computer over a network, execute commands in a remote machine and move files from one machine to another. It provides strong authentication and secure communications over insecure channels.

OpenSSH, the de facto open source SSH application, encrypts all traffic (including passwords) to effectively eliminate these risks. Additionally, OpenSSH provides myriad secure tunneling capabilities, as well as a variety of authentication methods.

OpenSSH is the port of OpenBSD's excellent OpenSSH[0] to Linux and other versions of UNIX. OpenSSH is based on the last free version of Tatu Ylonen's sample implementation, with all patent-encumbered algorithms removed (to external libraries), all known security bugs fixed, new features reintroduced and many other fixes. The only changes in the Tripp Lite SSH implementation are:

- PAM support.
- EGD[1]/PRNGD[2] support and replacements for OpenBSD library functions that are absent from other versions of UNIX.
- The config files are now in **/etc/config**. e.g.
 - o **/etc/config/sshd_config** instead of **/etc/sshd_config**
 - o **/etc/config/ssh_config** instead of **/etc/ssh_config**
 - o **/etc/config/users/<username>/.ssh /** instead of **/home/<username>/.ssh/**

15. Advanced Configuration

15.6.2 Generating Public Keys (Linux)

To generate new SSH key pairs, use the Linux **ssh-keygen** command. This will produce an RSA or DSA public/private key pair. You will be prompted for a path to store the two key files e.g. **id_dsa.pub** (the public key) and **id_dsa** (the private key). For example:

```
$ ssh-keygen -t [rsa|dsa]
Generating public/private [rsa|dsa] key pair.
Enter file in which to save the key (/home/user/.ssh/id_[rsa|dsa]):
Enter passphrase (empty for no passphrase):
Enter same passphrase again:
Your identification has been saved in /home/user/.ssh/id_[rsa|dsa].
Your public key has been saved in /home/user/.ssh/id_[rsa|dsa].pub.
The key fingerprint is:
 28:aa:29:38:ba:40:f4:11:5e:3f:d4:fa:e5:36:14:d6 user@server
$
```

It is advisable to create a new directory to store your generated keys. It is also possible to name the files after the device for which they will be used. For example:

```
$ mkdir keys
$ ssh-keygen -t rsa
Generating public/private rsa key pair.
Enter file in which to save the key (/home/user/.ssh/id_rsa): /home/user/keys/control_room
Enter passphrase (empty for no passphrase):
Enter same passphrase again:
Your identification has been saved in /home/user/keys/control_room
Your public key has been saved in /home/user/keys/control_room.pub.
The key fingerprint is:
 28:aa:29:38:ba:40:f4:11:5e:3f:d4:fa:e5:36:14:d6 user@server
$
```

You must ensure no password is associated with the keys. If there is a password, the Tripp Lite devices will have no way to supply it as runtime.

Full documentation for the ssh-keygen command can be found at <http://www.openbsd.org/cgi-bin/man.cgi?query=ssh-keygen> .

15. Advanced Configuration

15.6.3 Installing the SSH Public/Private Keys (Clustering)

For Tripp Lite console servers, the keys are simply uploaded through the web interface on the **System: Administration** page. This enables you to upload stored RSA or DSA Public Key pairs to the Primary device and apply the authorized key to the secondary device as described in **4. Serial Port, Host, Device and User Configuration**. Once complete, proceed to Fingerprinting, as described below.

SSH RSA Public Key	<input type="text"/>	<input type="button" value="Browse..."/>
	Upload a replacement RSA public key file.	
SSH RSA Private Key	<input type="text"/>	<input type="button" value="Browse..."/>
	Upload a replacement RSA private key file.	
SSH DSA Public Key	<input type="text"/>	<input type="button" value="Browse..."/>
	Upload a replacement DSA public key file.	
SSH DSA Private Key	<input type="text"/>	<input type="button" value="Browse..."/>
	Upload a replacement DSA private key file.	
SSH Authorized Keys	<input type="text"/>	<input type="button" value="Browse..."/>
	Upload a replacement authorized keys file.	

15.6.4 Installing SSH Public Key Authentication (Linux)

Alternately, the public key can be installed on the unit remotely from the Linux host with the **scp** utility as follows:

Assuming the user on the management console is called "fred"; the console server IP address is 192.168.0.1 (default). The public key is on the **linux/unix** computer in `~/.ssh/id_dsa.pub`. Execute the following command on the **linux/unix** computer:

```
scp ~/.ssh/id_dsa.pub \  
root@192.168.0.1:/etc/config/users/fred/.ssh/authorized_keys
```

The `authorized_keys` file on the console server needs to be owned by "fred". As such, log in to the management console as **root** and type:

```
chown fred /etc/config/users/fred/.ssh/authorized_keys
```

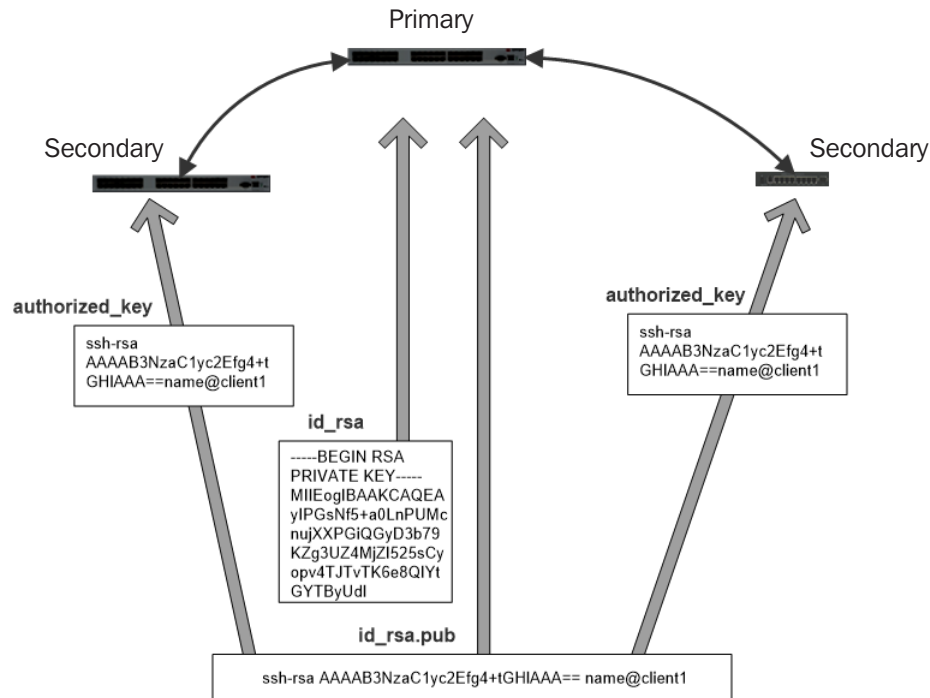

15. Advanced Configuration

If the Tripp Lite device selected to be the server will have only one client device, the **authorized_keys** file is simply a copy of the public key for that device. If one or more devices will be clients of the server, the **authorized_keys** file will contain a copy of all public keys. RSA and DSA keys may be freely mixed in the **authorized_keys** file. For example, assume we already have one server, called `bridge_server`, and two sets of keys for the `control_room` and the `plant_entrance`:

```
$ ls /home/user/keys control_room control_room.pub plant_entrance plant_entrance.pub $ cat /home/user/keys/control_room.pub /home/user/keys/plant_entrance.pub > /home/user/keys/authorized_keys_bridge_server
```

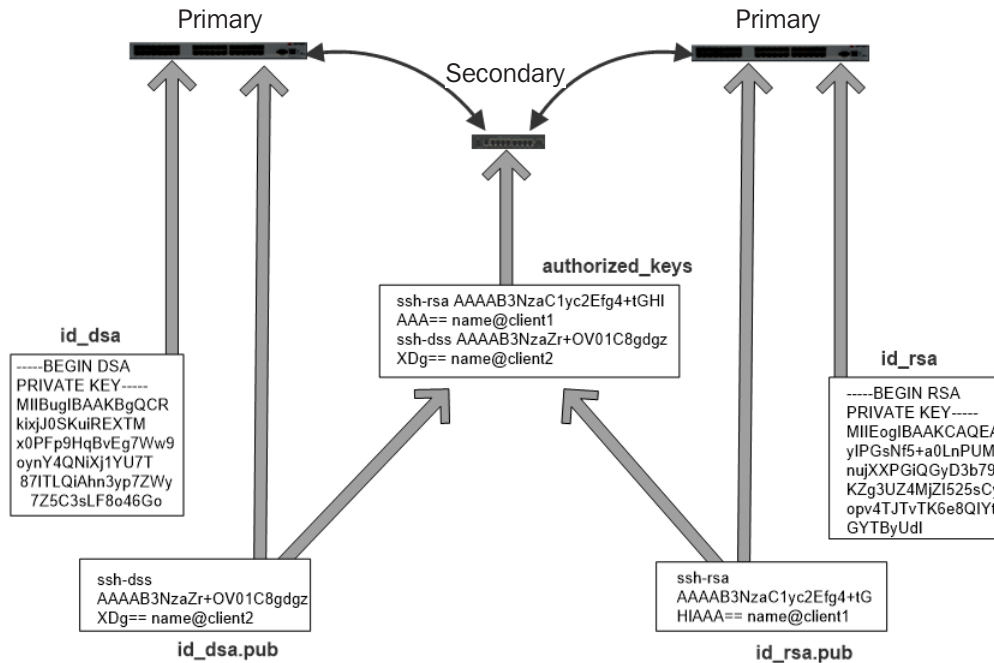

More documentation on OpenSSH can be found at:

- <http://openssh.org/portable.html>
- <http://www.openbsd.org/cgi-bin/man.cgi?query=ssh&sektion=1>
- <http://www.openbsd.org/cgi-bin/man.cgi?query=sshd>

15.6.5 Generating Public/Private Keys for SSH (Windows)

This section describes how to generate and configure SSH keys using Windows.

First, create a new user from the Tripp Lite management (the following example uses a user called “testuser”), making sure it is a member of the “users” group.

If you do not already have a public/private key pair, you can generate them now using **ssh-keygen**, **PuTTYgen** or a similar tool:

- PuTTYgen:** <http://www.chiark.greenend.org.uk/~sgtatham/putty/download.html>
- OpenSSH:** <http://www.openssh.org/>
- OpenSSH (Windows):** <http://sshhwindows.sourceforge.net/download/>

For example, when using PuTTYgen, make sure you have a recent version of the **puttygen.exe** (available from <http://www.chiark.greenend.org.uk/~sgtatham/putty/download.html>). Also, make sure you have a recent version of WinSCP (available from <http://winscp.net/eng/download.php>).

To generate a SSH key using PuTTY <http://sourceforge.net/docs/F02/#clients>:

- Execute the PUTTYGEN.EXE program.
- Select the desired key type **SSH2 DSA** (you may use RSA or DSA) within the **Parameters** section.
- It is important that you leave the passphrase field blank.
- Click on the **Generate** button.

15. Advanced Configuration

- Follow the instruction to move the mouse over the blank area of the program in order to create random data used by PUTTYGEN to generate secure keys. Key generation will occur once PUTTYGEN has collected sufficient random data.

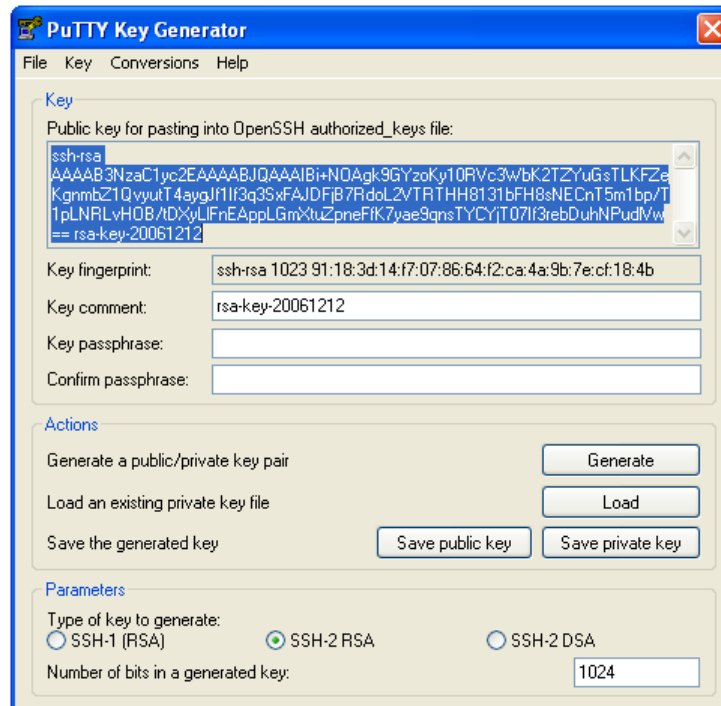

- Create a new file “ **authorized_keys** ” (with notepad) and copy your public key data from the “Public key for pasting into OpenSSH authorized_keys file” section of the PuTTY Key Generator. Paste the key data to the “authorized_keys” file. Make sure there is only one line of text in this file.
- Use WinSCP to copy this “authorized_keys” file into the user’s home directory. For example, **/etc/config/users/testuser/.ssh/authorized_keys** of the Tripp Lite gateway will be the SSH server. You will need to make sure this file is in the correct format with the correct permissions with the following commands:

```
# dos2unix \  
/etc/config/users/testuser/.ssh/authorized_keys && chown testuser \  
/etc/config/users/testuser/.ssh/authorized_keys
```

- Using WinSCP, copy the attached sshd_config over **/etc/config/sshd_config** on the server. Doing this ensures public key authentication is enabled.
- Test the Public Key by logging in as “testuser”. Test the Public Key by logging in as “testuser” to the client Tripp Lite device and typing (you should not need to enter anything):

```
# ssh -o StrictHostKeyChecking=no <server-ip>
```

To automate connection of the SSH tunnel from the client on every power-up, make the clients **/etc/config/rc.local** look like the following:

```
#!/bin/sh  
ssh -L9001:127.0.0.1:4001 -N -o StrictHostKeyChecking=no testuser@<server-ip> &
```

This will run the tunnel redirecting local port 9001 to the server port 4001.

15. Advanced Configuration

15.6.6 Fingerprinting

Fingerprints are used to ensure you are establishing an SSH session to who you think you are. On the first connection to a remote server, you will receive a fingerprint that can be used for future connections.

This fingerprint is related to the host key of the remote server. Fingerprints are stored in `~/.ssh/known_hosts`.

To receive the fingerprint from the remote server, log in to the client as the required user (usually root) and establish a connection to the remote host:

```
# ssh remhost
The authenticity of host 'remhost (192.168.0.1)' can't be established.
RSA key fingerprint is 8d:11:e0:7e:8a:6f:ad:f1:94:0f:93:fc:7c:e6:ef:56.
Are you sure you want to continue connecting (yes/no)?
```

Answer **yes** to accept the key. The following message will appear:

```
Warning: Permanently added 'remhost,192.168.0.1' (RSA) to the list of
known hosts.
```

You may be prompted for a password, though there is no need to log in; you will have received the fingerprint and can Ctrl+C to cancel the connection. If the host key changes, you will receive the following warning and not be allowed to connect to the remote host:

```
@@@@@@@@@@@@@@@@@@@@@@@@@@@@@@@@@@@@@@@@@@@@@@@@@@@@@@@@@@@@
@  WARNING: REMOTE HOST IDENTIFICATION HAS CHANGED!               @
@  IT IS POSSIBLE THAT SOMEONE IS DOING SOMETHING NASTY!         @
@@@@@@@@@@@@@@@@@@@@@@@@@@@@@@@@@@@@@@@@@@@@@@@@@@@@@@@@@@@@
```

Someone could be eavesdropping on you right now (man-in-the-middle attack)!

It is also possible that the RSA host key has just been changed.

The fingerprint for the RSA key sent by the remote host is:

```
ab:7e:33:bd:85:50:5a:43:0b:e0:bd:43:3f:1c:a5:f8.
```

Please contact your system administrator.

Add correct host key in `/.ssh/known_hosts` to get rid of this message.

Offending key in `/.ssh/known_hosts:1`

RSA host key for **remhost** has changed and you have requested strict checking.

Host key verification failed.

If the host key has been legitimately changed, it can be removed from the `~/.ssh/known_hosts` file with the new fingerprint added. If it has not changed, this indicates a serious problem that should be investigated immediately.

15.6.7 SSH Tunneled Serial Bridging

You have the option to apply SSH tunneling when two Tripp Lite console servers are configured for serial bridging.

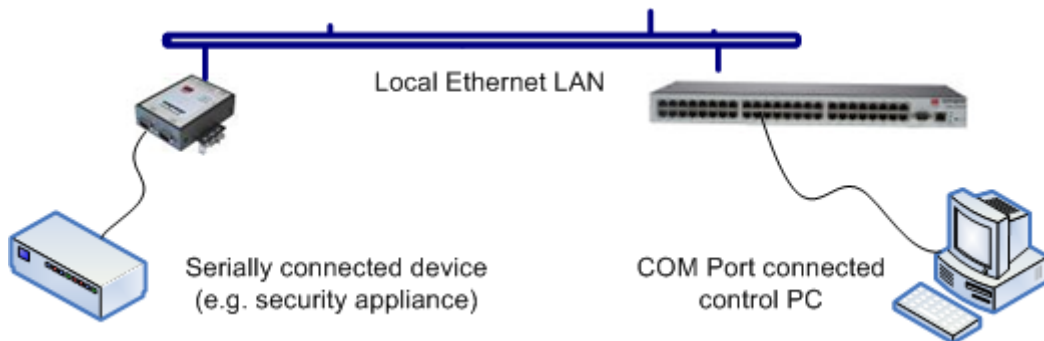

15. Advanced Configuration

As detailed in **4. Serial Port, Host, Device and User Configuration**, the server console server is set up in Console Server mode with either RAW or RFC2217 enabled, and the client console server is set up in Serial Bridging mode with the Server Address and Server TCP Port (4000 + port for RAW or 5000 + port # for RFC2217) specified:

- Select **SSH Tunnel** when configuring the **Serial Bridging Setting**.

Serial Bridge Settings	
Serial Bridging Mode	<input checked="" type="radio"/> Create a network connection to a remote serial port via RFC-2217.
Server Address	<input type="text" value="250.258.2.16"/> The network address of an RFC-2217 server to connect to.
Server TCP Port	<input type="text" value="5002"/> The TCP port the RFC-2217 server is serving on.
RFC 2217	<input checked="" type="checkbox"/> Enable RFC 2217 access.
SSH Tunnel	<input checked="" type="checkbox"/> Redirect the serial bridge over an SSH tunnel to the server

Next, you will need to set up SSH keys for each end of the tunnel and upload these keys to the server and client console servers.

Client Keys

The first step in setting up SSH tunnels is to generate keys. Ideally, you will use a separate, secure machine to generate and store all keys to be used on the console servers. However, if this is not ideal to your situation, keys may be generated on the console servers themselves.

It is possible to generate only one set of keys and reuse them for every SSH session. While this is not recommended, each organization will need to balance the security of separate keys against the additional administration they bring.

Generated keys may be one of two types - RSA or DSA (and it is beyond the scope of this document to recommend one over the other). RSA keys will go into the files **id_rsa** and **id_rsa.pub**. DSA keys will be stored in the files **id_dsa** and **id_dsa.pub**.

For simplicity, the term private key will be used from this point forward to refer to either **id_rsa** or **id_dsa** and public key to refer to either **id_rsa.pub** or **id_dsa.pub**.

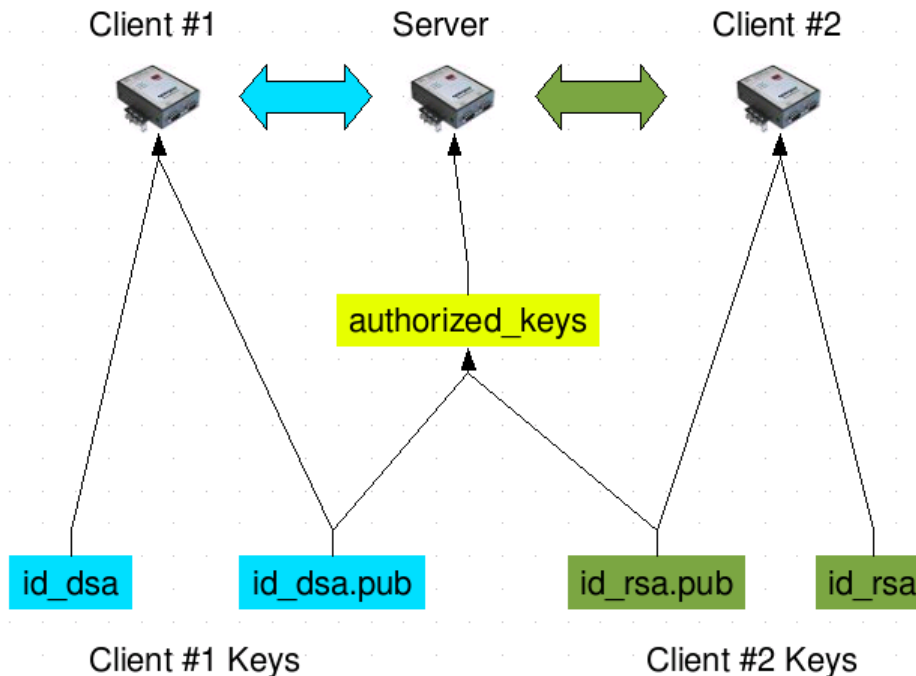

15. Advanced Configuration

To generate the keys using OpenBSD's OpenSSH suite, use the **ssh-keygen** program:

```
$ ssh-keygen -t [rsa|dsa]
Generating public/private [rsa|dsa] key pair.
Enter file in which to save the key (/home/user/.ssh/id_[rsa|dsa]):
Enter passphrase (empty for no passphrase):
Enter same passphrase again:
Your identification has been saved in /home/user/.ssh/id_[rsa|dsa].
Your public key has been saved in /home/user/.ssh/id_[rsa|dsa].pub.
The key fingerprint is:
 28:aa:29:38:ba:40:f4:11:5e:3f:d4:fa:e5:36:14:d6 user@server
$
```

It is advisable to create a new directory to store your generated keys. It is also possible to name the files after the device they will be used for. For example:

```
$ mkdir keys
$ ssh-keygen -t rsa
Generating public/private rsa key pair.
Enter file in which to save the key (/home/user/.ssh/id_rsa): /home/user/keys/control_room
Enter passphrase (empty for no passphrase):
Enter same passphrase again:
Your identification has been saved in /home/user/keys/control_room
Your public key has been saved in /home/user/keys/control_room.pub.
The key fingerprint is:
 28:aa:29:38:ba:40:f4:11:5e:3f:d4:fa:e5:36:14:d6 user@server
$
```

You should ensure there is no password associated with the keys. If there is a password, the console servers will have no way to supply it as runtime.

Authorized Keys

If the console server selected to be the server will have only one client device, then the **authorized_keys** file is simply a copy of the public key for that device. If one or more devices will be clients of the server, the **authorized_keys** file will contain a copy of all of the public keys. RSA and DSA keys may be freely mixed in the **authorized_keys** file.

For example, assume we already have one server, called **bridge_server**, and two sets of keys for the **control_room** and the **plant_entrance**:

```
$ ls /home/user/keys
control_room control_room.pub plant_entrance plant_entrance.pub
$ cat /home/user/keys/control_room.pub
/home/user/keys/plant_entrance.pub >
/home/user/keys/authorized_keys_bridge_server
```

Uploading Keys

The server keys can be uploaded through the web interface on the **System: Administration** page. If only one client will be connecting, simply upload the appropriate public key as the authorized keys file. Otherwise, upload the authorized keys file constructed in the previous step.

Each client will then need its own set of keys uploaded through the same page. Take care to ensure the correct type of keys (DSA or RSA) goes in the correct locations and that the public and private keys are in the correct location.

15. Advanced Configuration

15.6.8 SDT Connector Public Key Authentication

SDT Connector can authenticate against a console server using your SSH key pair, rather than requiring you to enter your password (i.e. public key authentication).

- To use public key authentication with SDT Connector, first create an RSA or DSA key pair (using **ssh-keygen**, **PuTTYgen** or a similar tool) and add the public part of your SSH key pair to the console server.
- Next, add the private part of your SSH key pair (this file is typically named **id_rsa** or **id_dsa**) to SDT Connector client. Click **Edit: Preferences: Private Keys: Add**, locate the private key file and click **OK**. You do not have to add the public part of your SSH key pair, it is calculated using the private key.

SDT Connector will now use public key authentication when SSH connects via console server. You may have to restart SDT Connector to shut down any existing tunnels that were established using password authentication.

If you have a host behind the console server that you connect to by clicking the SSH button in SDT Connector, you can also configure it for public key authentication. Essentially, what you are using is SSH over SSH. The two SSH connections are entirely separate, and the host configuration is entirely independent of SDT Connector and the console server. You must configure the SSH client that SDT Connector launches (e.g., Putty, OpenSSH) and the host's SSH server for public key authentication.

15.7 Secure Sockets Layer (SSL) Support

Secure Sockets Layer (SSL) is a protocol developed by Netscape for transmitting private documents via the Internet. SSL works by using a private key to encrypt data transferred over the SSL connection.

The console server includes OpenSSL. The OpenSSL Project is a collaborative effort to develop a robust, commercial-grade, full-featured and open source toolkit implementing the Secure Sockets Layer (SSL v2/v3) and Transport Layer Security (TLS v1) protocols, as well as a full-strength general-purpose cryptography library. The project is managed by a worldwide community of volunteers that use the Internet to communicate, plan and develop the OpenSSL toolkit and its related documentation.

OpenSSL is based on the Slay library developed by Eric A. Young and Tim J. Hudson. The OpenSSL toolkit is licensed under an Apache-style license, which means you are free to get and use it for commercial and non-commercial purposes subject to some simple license conditions. In the console server, OpenSSL is used primarily in conjunction with http in order to have secure browser access to the GUI management console across insecure networks.

More documentation on OpenSSL is available at:

<http://www.openssl.org/docs/apps/openssl.html>

<http://www.openssl.org/docs/HOWTO/certificates.txt>

15.8 HTTPS

The management console UI is served using HTTPS by the built in Cherokee webserver.

If your default network address is changed or the unit is to be accessed using a known domain name, you can use the following steps to replace the default SSL certificate and private key with those tailored for your new address.

15.8.1 Generating an Encryption Key

To create a 1024-bit RSA key with a password, issue the following command on the Linux host command line with the openssl utility installed:

```
openssl genrsa -des3 -out ssl_key.pem 1024
```

15. Advanced Configuration

15.8.2 Generating a Self-Signed Certificate with OpenSSL

This example shows how to use OpenSSL to create a self-signed certificate. OpenSSL is available for most Linux distributions using the default package management mechanism. Windows users can check by going to <http://www.openssl.org/related/binaries.html>.

To create a 1024-bit RSA key and a self-signed certificate, issue the following openssl command from the host you have **openssl** installed on:

```
openssl req -x509 -nodes -days 1000 \  
-newkey rsa:1024 -keyout ssl_key.pem -out ssl_cert.pem
```

You will be prompted to enter a lot of information. Most does not matter, but the “Common Name” should be the domain name of your computer (e.g., test.tripplite.com). Once everything has been entered, the certificate will be created in a file called **ssl_cert.pem**.

15.8.3 Installing the Key and Certificate

The recommended method for copying files securely to the console server is with an SCP (Secure Copying Protocol) client. The scp utility is distributed with OpenSSH for most UNIX distributions, while Windows users can use something like the PSCP command line utility available with PuTTY.

The files created in the steps above can be installed remotely with the **scp** utility as follows:

```
scp ssl_key.pem root@<address of unit>:/etc/config/  
scp ssl_cert.pem root@<address of unit>:/etc/config/
```

or using PSCP:

```
pscp -scp ssl_key.pem root@<address of unit>:/etc/config/  
pscp -scp ssl_cert.pem root@<address of unit>:/etc/config/
```

PuTTY and the PSCP utility can be downloaded from: <http://www.chiark.greenend.org.uk/~sgtatham/putty/download.html>.

More detailed documentation on the PSCP can be found at: <http://the.earth.li/~sgtatham/putty/0.58/html/doc/Chapter5.html#pscp>.

15.8.4 Launching the HTTPS Server

The easiest way to enable the HTTPS server is from the web management console. Simply click the appropriate checkbox in **Network: Services: HTTPS Server**. The HTTPS server will be activated, assuming the ssl_key.pem & ssl_cert.pem files exist in the /etc/config directory.

Alternately, **inetd** can be configured to launch the secure **fnord** server from the command line of the unit as follows.

Edit the **inetd** configuration file. From the unit command line:

```
vi /etc/config/inetd.conf
```

Append a line:

```
443 stream tcp nowait root sslwrap -cert /etc/config/ssl_cert.pem -key /etc/config/ssl_key.pem -exec /bin/httpd /home/httpd"
```

Save the file and signal **inetd** of the configuration change.

```
kill -HUP `cat /var/run/inetd.pid`
```

The HTTPS server should be accessible from a web client at a URL similar to: **https://<common name of unit>**

More detailed documentation about the **openssl** utility can be found at: <http://www.openssl.org/>

15. Advanced Configuration

15.9 Power Strip Control

The console server supports a growing list of remote power-control devices (RPCs), which can be configured using the management console as described in 8. Power, Environment and Digital I/O. These RPCs are controlled using the open source PowerMan and Network UPS Tools, and with Tripp Lite's pmpower utility.

15.9.1 PowerMan Tool

PowerMan provides power management in a data center or compute cluster environment. It performs operations such as power on, power off and power cycle via remote power controller (RPC) devices.

Synopsis

powerman [-option] [targets]

pm [-option] [targets]

Options

- 1**, --on Power ON targets.
- 0**, --off Power OFF targets.
- c**, --cycle Power cycle targets.
- r**, --reset Assert hardware reset for targets (if implemented by RPC).
- f**, --flash Turn beacon ON for targets (if implemented by RPC).
- u**, --unflash Turn beacon OFF for targets (if implemented by RPC).
- l**, --list List available targets. If possible, output will be compressed into a host range (see TARGET SPECIFICATION below).
- q**, --query Query plug status of targets. If none specified, query all targets. Status is not cached; each time this option is used, PowerMan queries the appropriate RPCs. Targets connected to RPCs that could not be contacted (e.g., due to network failure) are reported as status "unknown". If possible, output will be compressed into host ranges.
- n**, --node Query node power status of targets (if implemented by RPC). If no targets are specified, query all targets. In this context, a node in the OFF state could be ON at the plug, but operating in standby power mode.
- b**, --beacon Query beacon status (if implemented by RPC). If no targets are specified, query all targets.
- t**, --temp Query node temperature (if implemented by RPC). If no targets are specified, query all targets. Temperature information is not interpreted by PowerMan and is reported as received from the **RPC on one line per target, prefixed by target name.**
- h**, --help Display option summary.
- L**, --license Show PowerMan license information.
- d**, --destination host[:port] Connect to a PowerMan daemon on non-default host and optional port.
- V**, --version Display the PowerMan version number and exit.
- D**, --device Displays RPC status information. If targets are specified, only RPCs matching the target list are displayed.
- T**, --telemetry Causes RPC telemetry information to be displayed as commands are processed. Useful for debugging device scripts.
- x**, --exprange Expand host ranges in query responses.

For more details, refer to <http://linux.die.net/man/1/powerman>.

Also, refer to powermand (<http://linux.die.net/man/1/powermand>) documentation and **powerman.conf** (<http://linux.die.net/man/5/powerman.conf>).

15. Advanced Configuration

Target Specification

PowerMan target hostnames may be specified as comma-separated or space-separated hostnames or host ranges. Host ranges are of the general form: prefix[n-m,l-k,...], where $n < m$ and $l < k$, etc. This form should not be confused with regular expression character classes (also denoted by “[]”). For example, foo[19] does not represent foo1 or foo9, but rather represents a degenerate range: foo19.

This range syntax is meant only as a convenience on clusters with a prefix NN naming convention. Range specification should not be considered necessary; the list foo1,foo9 could be specified as such, or by the range foo[1,9].

Some examples of PowerMan targets include:

Power on hosts bar,baz,foo01,foo02,...,foo05: **powerman --on bar baz foo[01-05]**

Power on hosts bar,foo7,foo9,foo10: **powerman --on bar,foo[7,9-10]**

Power on foo0,foo4,foo5: **powerman --on foo[0,4-5]**

As a reminder, some shells will interpret brackets ([and]) for pattern matching. Depending on your shell, it may be necessary to enclose ranged lists within quotes. For example, in tcsh, the last example above should be executed as:

```
powerman --on "foo[0,4-5]"
```

15.9.2 Pmpower tool

The **pmpower** utility is a high-level tool for manipulating remote preconfigured power devices connected to the console server via serial or network connection. The PDU, UPS and IPMI power devices are variously controlled using the open source **PowerMan**, **IPMItool** or **Network UPS Tools**. Tripp Lite's **pmpower** utility arches over these tools so devices can be controlled through the one command line:

```
pmpower [-?h] [-l device | -r host] [-o outlet] [-u username] [-p password] action
```

-?/-h This help message.

-l The serial port to use.

-o The outlet on the power target to apply to.

-r The remote host address for the power target.

-u Override the configured username.

-p Override the configured password.

on This **action** switches the specified device or outlet(s) on.

off This **action** switches the specified device or outlet(s) off.

cycle This **action** switches the specified device or outlet(s) off and on again.

status This **action** retrieves the current status of the device or outlet.

Examples:

To turn outlet 4 of the power device connected to serial port 2 on: **# pmpower -l port02 -o 4 on**

To turn an IPMI device off located at IP address 192.168.1.100 (where username is 'root' and password is 'calvin'): **# pmpower -r 192.168.1.100 -u root -p calvin off**

Default system power device actions are specified in **/etc/powerstrips.xml**. Custom power devices can be added in **/etc/config/powerstrips.xml**. If an action is attempted which has not been configured for a specific power device, **pmpower** will exit with an error.

15. Advanced Configuration

15.9.3 Adding New RPC Devices

There are a number of simple paths to adding support for new RPC devices.

The first is to have scripts support the particular RPC included in either the open source **PowerMan** project (<http://sourceforge.net/projects/powerman>) or the open source **NUT UPS Tools** project. The PowerMan device specifications are rather peculiar, and it is suggested you leave the actual writing of these scripts to the PowerMan authors. However, documentation on how they work can be found at <http://linux.die.net/man/5/powerman.dev>. The Network UPS Tools (NUT) project has recently moved on from its UPS management origins to also cover SNMP PDUs (and embrace PowerMan). Tripp Lite progressively includes the updated PowerMan and NUT build into the console server firmware releases.

The second path is to directly add support for the new RPC devices (or to customize the existing RPC device support) on your console server. The **Manage: Power** page uses information contained in `/etc/powerstrips.xml` to configure and control devices attached to a serial port. The configuration also searches for (and loads) `/etc/config/powerstrips.xml` (if it exists).

The user can add their own support for more devices by adding their definitions into `/etc/config/powerstrips.xml`. This file can be created on a host system and copied to the management console device using `scp`. Alternately, log in to the management console and use `ftp` or `wget` to transfer files.

Here is a brief description of the elements of the XML entries in `/etc/config/powerstrips.xml`:

```
<powerstrip>
  <id>Name or ID of the device support</id>
  <outlet port="port-id-1">Display Port 1 in menu</outlet>
  <outlet port="port-id-2">Display Port 2 in menu</outlet>
  ...
  <on>script to turn power on</on>
  <off>script to power off</off>
  <cycle>script to cycle power</cycle>
  <status>script to write power status to /var/run/power-status</status>
  <speed>baud rate</speed>
  <charsize>character size</charsize>
  <stop>stop bits</stop>
  <parity>parity setting</parity>
</powerstrip>
```

The **id** appears on the web page in the list of available devices types to configure.

The outlets describe targets that the scripts can control. For example, a power control board may control several different outlets. The port-id is the native name for identifying the outlet. This value will be passed to the scripts in the environment variable `outlet`, allowing the script to address the correct outlet.

There are four possible scripts: **on**, **off**, **cycle** and **status**.

When a script is run, its standard input and output is redirected to the appropriate serial port. The script receives the outlet and port in the **outlet** and **port** environment variables, respectively.

The script can be anything that can be executed within the shell.

All of the existing scripts in `/etc/powerstrips.xml` use the `pmchat` utility.

`pmchat` works just like the standard UNIX “chat” program, except it ensures interoperation with the port manager.

The final options **speed**, **charsize**, **stop** and **parity** define the recommended or default settings for the attached device.

15. Advanced Configuration

15.10 IPMItool

The console server includes the `ipmitool` utility for managing and configuring devices that support the Intelligent Platform Management Interface (IPMI) versions 1.5 and 2.0 specifications.

IPMI is an open standard for monitoring, logging, recovery, inventory and control of implemented hardware independent of the main CPU, BIOS and OS. The service processor (or Baseboard Management Controller, BMC) is the brain behind platform management. Its primary purpose is to handle autonomous sensor monitoring and event logging.

The `ipmitool` program provides a simple command-line interface to the BMC. It features the ability to read the sensor data repository (SDR) and print sensor values, display the contents of the System Event Log (SEL), print Field Replaceable Unit (FRU) inventory information, read and set LAN configuration parameters, and perform remote chassis power control.

SYNOPSIS

```
ipmitool [-c|-h|-v|-V] -I open <command>
```

```
ipmitool [-c|-h|-v|-V] -I lan -H <hostname>
```

```
[-p <port>]
```

```
[-U <username>]
```

```
[-A <authtype>]
```

```
[-L <privlvl>]
```

```
[-a|-E|-P|-f <password>]
```

```
[-o <oemtype>]
```

```
<command>
```

```
ipmitool [-c|-h|-v|-V] -I lanplus -H <hostname>
```

```
[-p <port>]
```

```
[-U <username>]
```

```
[-L <privlvl>]
```

```
[-a|-E|-P|-f <password>]
```

```
[-o <oemtype>]
```

```
[-C <ciphersuite>]
```

```
<command>
```

Description

This program lets you manage Intelligent Platform Management Interface (IPMI) functions of either the local system via a kernel device driver or a remote system using IPMI version 1.5 and 2.0. These functions include printing FRU information, LAN configuration, sensor readings and remote chassis power control.

IPMI management of a local system interface requires a compatible IPMI kernel driver to be installed and configured. On Linux systems, this driver is called **OpenIPMI** and is included in standard distributions. On Solaris systems, this driver is called **BMC** and is included in Solaris 10. Management of a remote station requires the IPMI-over-LAN interface to be enabled and configured. Depending on the particular requirements of each system, it may be possible to enable the LAN interface using `ipmitool` over the system interface.

Options

- a** Prompt for the remote server password.
- A <authtype>** Specify an authentication type to use during IPMIv1.5 **lan** session activation. Supported types are NONE, PASSWORD, MD5, or OEM.
- c** Present output in CSV (comma separated variable) format. This is not available with all commands.
- C <ciphersuite>** The remote server authentication, integrity, and encryption algorithms to use for IPMIv2 **lanplus** connections. See table 22-19 in the IPMIv2 specification. The default is 3, which specifies RAKP-HMAC-SHA1 authentication, HMAC-SHA1-96 integrity, and AES-CBC-128 encryption algorithms.
-E The remote server password is specified by the environment variable **IPMI_PASSWORD**.
- f <password_file>** Specifies a file containing the remote server password. If this option is absent, or if `password_file` is empty, the password will default to NULL.
- h** Get basic usage help from the command line.

15. Advanced Configuration

- H <address>** Remote server address. Can be IP address or hostname. This option is required for **lan** and **lanplus** interfaces.
- I <interface>** Selects IPMI interface to use. Supported interfaces that are compiled in are visible in the usage help output.
- L <privlvl>** Force session privilege level. Can be CALLBACK, USER, OPERATOR, and ADMIN. Default is ADMIN.
- m <local_address>** Set the local IPMB address. The default is 0x20. There is no need to change this setting under normal operation.
- o <oemtype>** Select the OEM type to support. This usually involves minor hacks in place in the code to work around quirks in various BMCs from various manufacturers. Use **-o list** to see a list of current supported OEM types.
- p <port>** Remote server UDP port to connect to. Default is 623.
- P <password>** Remote server password is specified on the command line. If supported, it will be obscured in the process list.
Note: Specifying the password as a command line option is not recommended.
- t <target_address>** Bridge IPMI requests to the remote target address.
- U <username>** Remote server username, default is NULL user.
- v** Increase verbose output level. This option may be specified multiple times to increase the level of debug output. If given three times, you will get hexdumps of all incoming and outgoing packets.
- V** Display version information.

If no password method is specified, ipmitool will prompt the user for a password. If no password is entered at the prompt, the remote server password will default to NULL.

Security

The ipmitool documentation highlights several security issues that should be considered before enabling the IPMI LAN interface. A remote station has the ability to control a system's power state as well as the ability to gather certain platform information. To reduce vulnerability, it is strongly advised that the IPMI LAN interface only be enabled in trusted environments where system security is not an issue, where there is a dedicated secure management network, or access has been provided through a console server.

It is strongly advised you should not enable IPMI for remote access without setting a password and that the password should not be the same as any other password on that system.

When an IPMI password is changed on a remote machine with the IPMIv1.5 lan interface, the new password is sent across the network as clear text. This could be observed and then used to attack the remote system. As such, it is recommended that IPMI password management only be performed over IPMIv2.0 lanplus interface or the system interface on the local station.

For IPMI v1.5, the maximum password length is 16 characters. Passwords longer than 16 characters will be truncated.

For IPMI v2.0, the maximum password length is 20 characters. Passwords longer than 20 characters will be truncated.

Commands

- help** This can be used to get command-line help on **ipmitool** commands. It may also be placed at the end of commands to get option usage help.
- ipmitool help** Commands:
 - raw** Send a RAW IPMI request and print response
 - lan** Configure LAN Channels
 - chassis** Get chassis status and set power state
 - event** Send pre-defined events to MC
 - mc** Management Controller status and global enables
 - sdr** Print Sensor Data Repository entries and readings
 - sensor** Print detailed sensor information

15. Advanced Configuration

fru	Print built-in FRU and scan SDR for FRU locators
sel	Print System Event Log (SEL)
pef	Configure Platform Event Filtering (PEF)
sol	Configure IPMIv2.0 Serial-over-LAN
isol	Configure IPMIv1.5 Serial-over-LAN
user	Configure Management Controller users
channel	Configure Management Controller channels
session	Print session information
exec	Run list of commands from file
set	Set runtime variable for shell and exec

ipmitool chassis help Chassis Commands: status, power, identify, policy, restart_cause, poh, bootdev

ipmitool chassis power help chassis power Commands: status, on, off, cycle, reset, diag, soft

You will find more details on ipmitools at <http://ipmitool.sourceforge.net/manpage.html>.

15.11 Custom Development Kit (CDK)

Copy scripts, binaries and configuration files directly to the console server.

Tripp Lite also provides a free development kit that allows changes to be made to the software in console server firmware image. The customer can use the CDK to:

- Generate a firmware image without certain programs such as telnet, which may be banned by company policy.
- Generate an image with new programs such as custom Nagios plug-in binaries or company specific binary utilities.
- Generate an image with custom defaults (e.g., it may be required that the console server be configured to have a specific default serial port profile which is reverted to in the event of a factory reset.
- Place configuration files into the firmware image, which cannot then be modified. For example, # /bin/config --set= tools update the configuration files in /etc/config which are read/write, whereas the files in /etc are read only and cannot be modified.

The CDK provides a snapshot of the Tripp Lite build process (taken after the programs have been compiled and copied to a temporary directory romfs) just before the compressed file systems are generated.

When the console servers are cascaded, the Primary unit is in control of the serial ports on the Secondary units, and the primary's management console provides a consolidated view of the settings for both its own and all the secondary unit's serial ports. However, the Primary unit does not provide a fully consolidated view. For example, **Status: Active Users** only displays those users active on the Primary unit's ports; you will need to write a custom bash script that parses the port logs if you want to find out who's logged in to cascaded serial ports from the Primary.

You will also want to enable remote or USB logging. Local logs only buffer 8K of data and do not persist between reboots.

This script would parse each port log file line by line. For example, each time it sees **'LOGIN: username'**, it adds username to the list of connected users for that port, and each time it sees **'LOGOUT: username'** it removes it from the list. In doing this, the list can be neatly formatted and displayed. It is also possible to run this as a CGI script on the remote log server.

To enable log storage and connection logging:

- Select **Alerts & Logging: Port Log**.
- **Configure** log storage.
- Select **Serial & Network: Serial Port**. Edit the serial port(s).
- Under **Console server**, select **Logging Level 1** and click **Apply**.

A useful tutorial on creating a bash script CGI can be found at: <http://www.yolinux.com/TUTORIALS/LinuxTutorialCgiShellScript.html>

15. Advanced Configuration

Similarly, the Primary unit will maintain a view of the status of the secondary units:

- Select **Status: Support Report**.
- Scroll down to **Processes**.
- Look for: **/bin/ssh -MN -o ControlPath=/var/run/cascade/%h Secondaryname**
These are the Secondary units that are connected.
- The end of the Secondary units' names will be truncated, so the first five characters must be unique.

Alternately, you can write a custom CGI script as described above. The connected Secondary units can be determined by running: `ls /var/run/cascade`. The configured Secondaries can be displayed by running: `config -g config.cascade.Secondarys`

15.12 SMS Server Tools

Firmware releases V3.1 and later include the SMS Server Tools software, which provides an SMS gateway that sends and receives short messages through GSM modems and mobile phones.

You can send short messages by simply storing text files into a special spool directory. The program monitors this directory and sends new files automatically. It also stores received short messages into another directory as text files. Binary messages (including Unicode text) are also supported (e.g., ring tone messages). It is also possible to send a WAP Push message to the WAP / MMS capable mobile phone.

The program can be run as an SMS daemon, which can be started automatically when the operating system starts. High availability can be ensured by using multiple GSM devices (currently up to 64, though this limit is easily changeable).

The program can run other external programs or scripts after events like receiving a new message and successfully sending a message. It can inform when the program detects a problem. These programs can inspect the related text files and perform automatic actions

The SMS Server Tools software needs a GSM modem (or mobile phone) with SMS command set according to the European specifications GSM 07.05 (=ETSI TS 300 585) and GSM 03.38 (=ETSI TS 100 900). AT command set is supported. Devices can be connected with serial port, infrared or USB.

For more information, refer to <http://smstools3.kekekasvi.com>.

15.13 Multicast

By default, all Tripp Lite console servers come with multicasting enabled. Multicasting provides Tripp Lite products with the ability to simultaneously transmit information from a single device to a select group of hosts.

Multicasting can be disabled and re-enabled from the command line when used with firmware release version 3.1 and later. To disable multicasting type:

```
ifconfig eth0 -multicast
```

To re-enable multicasting from the command line type:

```
ifconfig eth0 multicast
```

IPv6 may need to be restarted when toggling between multicast states.

15. Advanced Configuration

15.14 Bulk Provisioning

Tripp Lite devices include wizard scripts to facilitate configuration and deployment en masse. These wizards operate at the command line level, so knowledge of the Linux command line and shell scripting is useful, but not necessary. Rather, they aim to be sufficiently user-friendly for remote hands to manage. This bulk-provisioning feature is supported by firmware version 3.9.1 or later.

The basic steps are:

1. Configure an individual “**golden Primary**” appliance with the baseline configuration shared by all Tripp Lite devices. This may be a minimal configuration if the installs are quite diverse, or a complete configuration when dealing with replicated installs.
2. Use make-template to turn the golden Primary’s active configuration into a template configuration that may be applied to other devices.
3. Create an OPG backup of the templated golden Primary appliance.
4. Restore this configuration to each target devices via the CLI, web UI or using a USB thumb drive.
5. Login via the CLI to complete configuration using **setup-wizard**.

15.15 Zero Touch Provisioning

Zero Touch Provisioning (ZTP) was introduced with firmware release 3.15.1 to allow Tripp Lite devices to be provisioned during their initial boot from a DHCP server.

15.15.1 Preparation

These are typical steps for configuration over a trusted network:

1. Configure a same-model Tripp Lite device.
2. Optionally use the Bulk Provisioning wizard scripts to remove any appliance-specific settings (i.e. create a template configuration). Refer to **15.14 Bulk Provisioning** for more information.
3. Save the configuration as a Tripp Lite backup (.opg) file under **System: Configuration Backup** in the web UI, or via config -e in the CLI. Alternately, you can save the XML configuration as a file ending in **.xml**.
4. Publish the .opg or.xml file on a fileserver that understands one of the HTTPS, HTTP, FTP or TFTP protocols.
5. Configure your DHCP server to include a “vendor specific” option for Tripp Lite devices. The option text should be a URL to the location of the .opg or .xml file. The option text should not exceed 250 characters in length. It must end in either .opg or .xml.
6. Connect a new Tripp Lite device (either at defaults from the factory, or config erased) to the network. Apply power.
7. It may take up to 5 minutes for the device to find the .opg or .xml file via DHCP, download, install file and reboot.

15.15.2 Example ISC DHCP Server Configuration

The following is an example of an ISC DHCP server configuration fragment for serving an .opg configuration image:

```
option space tripp-lite code width 1 length width 1;
option tripp-lite.config-url code 1 = text;
class " tripp-lite -ztp" {
  match if option vendor-class-identifier ~ ~ " ^ Tripp Lite /";
  vendor-option-space tripp-lite;
  option tripp-lite.config-url "https://example.com/opg/${class}.opg";
}
```

For other DHCP servers, please consult their documentation on specifying “Vendor Specific” option fields. We use sub-option 1 to hold the URL text.

15. Advanced Configuration

15.15.3 Set Up an Untrusted LAN

If network security is a concern, you can have remote hands insert a trusted USB flash drive into the Tripp Lite device during provisioning. A summary of the steps required for deploying configuration in an untrusted network is outlined below:

1. Generate an X.509 certificate for the client. Place it and its private key file onto a USB flash drive (concatenated as a single file, client.pem).
2. Set up an HTTPS server that restricts access to the .opg or .xml file for HTTPS connections, providing the client certificate.
3. Save a copy of the CA cert (that signed the HTTP server's certificate) onto the USB flash drive as well (ca-bundle.crt).
4. Insert the USB flash drive into the Tripp Lite device **before connecting to power or the network**.
5. Continue with the steps above, but using only a https URL.
6. A detailed step-by-step document for preparing a USB flash drive and using OpenSSL to create keys is at [Howto: set up a USB key for authenticated restore](#).

15.15.4 How it Works

This section explains in detail how the Tripp Lite device uses DHCP to obtain its initial configuration.

A Tripp Lite console manager is either configured or unconfigured. ZTP needs it to be in an unconfigured state, which is only obtained in the following ways:

- Firmware programming at factory.
- Pressing the **Config Erase** button twice during operation.
- Selecting **Config Erase** under **System: Administration** in the web UI, and rebooting.
- Creating the file `/etc/config/.init` and then rebooting (command-line).

When an unconfigured Tripp Lite boots, it performs these steps to find a configuration:

- The Tripp Lite device transmits a DHCP DISCOVER request onto its primary network interface (WAN). This DHCP request will carry a vendor class identifier of the form Tripp Lite/model-name (for example, Tripp Lite/B098) and its parameter request list will include option 43 (vendor-specific information).
- On receipt of a DHCP OFFER, the device will use the information in the offer to assign an IPv4 address to its primary network interface, add a default route, and prepare its DNS resolver.
- If the offer also contained an option 43 with sub-option 1, the device interprets the sub-option as a whitespace-separated list of URLs to configuration files to try to restore.
- If an NTP server option was provided in the DHCP offer, the system clock is (quickly) synchronized with the NTP server.
- The system now searches all attached USB storage devices for two optional certificate files. The first file is named ca-bundle.crt, and the second one is whichever one of the following filenames is found first:
 - o client-AABBCCDDEEFF.pem (where AABBCCDDEEFF is the MAC address of the primary network interface); or
 - o client-MODEL.pem (where MODEL is the (vendor class) model name in lowercase, truncated to before the first hyphen); or
 - o client.pem
- If both files are found (ca-bundle.crt and a client.pem), then secure mode is enabled for the next section.
- Each URL in the list obtained from option 43 sub-option 1 is tried in sequence until one succeeds:
 - o The URL undergoes substring replacement from the following table:

Substring	Replaced by
<code>\${mac}</code>	The 12-digit MAC address of the device, in lowercase
<code>\${model}</code>	The full model name, in lowercase
<code>\${class}</code>	The firmware hardware class
<code>\${version}</code>	The firmware version number

- o The resulting URL must end in .opg or .xml (an optional ?query-string is permitted). If it does not, it is skipped and the next URL is tried.

15. Advanced Configuration

- o In secure mode, the URL must use the https scheme or it is skipped.
- o Otherwise, the available schemes are: http https tftp ftp ftps.
- o The curl program is used to download the URL.
- o In secure mode, the server's certificate must validate against the ca-bundle.crt. The (required) client.pem file is provided to authenticate the client to the server. Please see the curl documentation for the format of these files.
- The URL is downloaded. For .opg files, its header is checked to see if it is compatible with the current device. For .xml files, a parse check is made. If the check fails, the downloaded file is abandoned and the next URL is tried.
- The file is imported into the current configuration.
- The system checks to see if a hostname has been set in the config. If not, it is set to \${model}-\${mac}.
- The system checks to see if it is still in an unconfigured state. If it is, then the network interface mode is set to DHCP. This effectively forces the system into a configured state, preventing a future reboot loop.
- The system reboots.

Notes: If all the URLs were skipped or failed, the system will wait for 30 seconds before retrying. It will retry all URLs up to 10 times. After the 10th retry, the system will reboot. If the system has been manually configured in the meantime, the retries will stop and ZTP will be disabled.

If no option 43 is received over DHCP, no URLs are downloaded and no reboots occur: the system must be manually configured. Once configured (manually or by ZTP), a Tripp Lite device will no longer request option 43 from the DHCP server, and it will ignore option 43 configuration URLs presented to it.

15.16 Internal Storage

Some models have an internal USB flash drive, a non-volatile **NAND** flash partition, or both, which can be used by portmanager for log storage and the TFTP/FTP server for file storage.

These storage devices are automatically mounted as subdirectories of /var/mnt/. The default directory served by FTP or TFTP is set to the preferred internal storage (if any). Otherwise, it is set to the first detected attached USB storage. The location of portmanager logs must be manually configured.

15.16.1 Filesystem Location of FTP/TFTP Directory

Product	Preferred storage	Directory
B093	Internal flash	/var/mnt/storage.nvlog/tftpboot/
B097	Internal USB flash	/var/mnt/storage.usb/tftpboot/
B098	Internal USB flash	/var/mnt/storage.usb/tftpboot/

15.16.2 Filesystem Location of Portmanager Logs

Port log server type	Directory
USB Flash Memory	/var/mnt/storage.usb/
Non-volatile internal storage	/var/mnt/storage.nvlog/
MicroSD Card	/var/mnt/storage.sd/
Other (NFS, CIFS, etc.)	As explicitly configured

15. Advanced Configuration

15.16.3 Configuring FTP/TFTP Directory

The FTP or TFTP services can be configured to serve different directories via the command line. For example:

```
config -s config.services.ftp.directory=/var/mnt/storage.usb/my-ftp-dir
config -r services
```

The directory will be created if it does not already exist.

15.16.4 Mounting a Preferred USB Disk by Label

The “first” USB storage device is mounted at `/var/mnt/storage.usb` by detecting the lowest numbered disk partition (e.g., `/dev/sda1`). However, this can be constrained to match a particular port or a labelled device.

1. Attach the USB disk you plan to use.
2. Look in directories `/dev/disk/by-path/` or `/dev/disk/by-label/` to find a suitably stable way of identifying your disk.
3. Use the following command to see the current device matching string used:

```
config -g config.storage.usb.device
```

4. Change the path match with (for example):

```
config -s config.storage.usb.device=/dev/disk/by-label/1103
```

APPENDIX A: Linux Commands and Source Code

The console server platform is a dedicated Linux computer optimized to provide monitoring and secure access to serial and network consoles of critical server systems and their supporting power and networking infrastructure.

Tripp Lite console servers are built on the uCLinux distribution as developed by the uCLinux project. This is GPL code, whose source can be found at <http://cvs.uclinux.org>.

Some uCLinux commands have config files that can be altered (e.g., portmanager, inetd, init, sshd).

Other commands you can run and configure (e.g., loopback, bash (shell), ftp, hwclock, iproute, iptables, netcat, ifconfig, mii-tool, netstat, route, ping, portmap, pppd, routed, setserial, smtpclient, stty, stunnel, tcpdump, tftp, tip, traceroute).

Below are most of the standard uCLinux and Busybox commands (and some custom Tripp Lite commands) that are in the default build tree. The Administrator can use these to configure the console server, and monitor and manage attached serial console and host devices:

addgroup *	Add a group or add a user to a group
adduser *	Add a user
agetty	Alternative Linux getty
arp	Manipulate the system ARP cache
arping	Send ARP requests/replies
bash	GNU Bourne-Again Shell
busybox	Swiss army knife of embedded Linux commands
cat *	Concatenate FILE(s) and print them to stdout
chat	Useful for interacting with a modem connected to stdin/stdout
chgrp *	Change file access permissions
chmod *	Change file access permissions
chown *	Change file owner and group
config	Tripp Lite tool to manipulate and query the system configuration from the command line
cp *	Copy files and directories
date *	Print or set the system date and time
dd *	Convert and copy a file
deluser *	Delete USER from the system
df *	Report file system disk space usage
dhcpd	Dynamic Host Configuration Protocol server
discard	Network utility that monitors the discard port
dmesg *	Print or control the kernel ring buffer
echo *	Print the specified ARGs to stdout
erase	Tool for erasing MTD partitions
eraseall	Tool for erasing entire MTD partitions
false *	Do nothing, unsuccessful
find	Search for files
flashw	Write data to individual flash devices
flatfsd	Daemon to save RAM file systems back to FLASH
ftp	Internet file transfer program
gen-keys	SSH key generation program
getopt *	Parses command options
gettyd	Getty daemon
grep *	Print lines matching a pattern
gunzip *	Compress or expand files

APPENDIX A: Linux Commands and Source Code

gzip *	Compress or expand files
hd	ASCII, decimal, hexadecimal, octal dump
hostname *	Get or set hostname or DNS domain name
httpd	Listen for incoming HTTP requests
hwclock	Query and set hardware clock (RTC)
inetd	Network super-server daemon
inetd-echo	Network echo utility
init	Process control initialization
ip	Show or manipulate routing, devices, policy routing and tunnels
ipmitool	Linux IPMI manager
iptables	Administration tool for IPv4 packet filtering and NAT
ip6tables	Administration tool for IPv6 packet filtering
iptables-restore	Restore IP Tables
iptables-save	Save IP Tables
kill *	Send a signal to a process to end gracefully
ln *	Make links between files
login	Begin session on the system
loopback	Tripp Lite loopback diagnostic command
loopback1	Tripp Lite loopback diagnostic command
loopback2	Tripp Lite loopback diagnostic command
loopback8	Tripp Lite loopback diagnostic command
loopback16	Tripp Lite loopback diagnostic command
loopback48	Tripp Lite loopback diagnostic command
ls *	List directory contents
mail	Send and receive mail
mkdir *	Make directories
mkfs.jffs2	Create an MS-DOS file system under Linux
mknod *	Make block or character special files
more *	File perusal filter for crt viewing
mount *	Mount a file system
msmtp	SMTP mail client
mv *	Move (rename) files
nc	TCP/IP Swiss army knife
netflash	Upgrade firmware on uLinux platforms using the blkmem interface
netstat	Print network connections, routing tables, interface statistics, etc.
ntpd	Network Time Protocol (NTP) daemon
pgrep	Display process(es) selected by regex pattern
pidof	Find the process ID of a running program
ping	Send ICMP ECHO_REQUEST packets to network hosts
ping6	IPv6 ping
pkill	Sends a signal to process(es) selected by regex pattern
pmchat	Tripp Lite command similar to the standard chat command (via portmanager)
pmdeny	

APPENDIX A: Linux Commands and Source Code

pminetd	
pmloggerd	
pmshell	Tripp Lite command similar to the standard tip or cu, but all serial port access is directed via the portmanager
pmusers	Tripp Lite command to query portmanager for active user sessions
portmanager	Tripp Lite command that handles all serial port access
portmap	DARPA port to RPC program number mapper
pppd	Point-to-Point protocol daemon
ps *	Report a snapshot of the current processes
pwd *	Print name of current/working directory
reboot *	Soft reboot
rm *	Remove files or directories
rmdir *	Remove empty directories
routed	Show or manipulate the IP routing table
routed	Show or manipulate the IP routing table
route	IP Route tool to flush IPv4 routes
route	IP Route tool to list routes
rtacct	Applet printing /proc/net/route
rtmon	RTnetlink listener
scp	Secure copy (remote file copy program)
sed *	Text stream editor
setmac	Sets the MAC address
setserial	Sets and reports serial port configuration
sh	Shell
showmac	Shows MAC address
sleep *	Delay for a specified amount of time
smbmnt	Helper utility for mounting SMB file systems
smbmount	Mount an SMBFS file system
smbumount	SMBFS umount for normal users
snmpd	SNMP daemon
snmptrap	Sends an SNMP notification to a manager
sredird	RFC 2217 compliant serial port redirector
ssh	OpenSSH SSH client (remote login program)
ssh-keygen	Authentication key generation, management and conversion
sshd	OpenSSH SSH daemon
stty	Change and print terminal line settings
stunnel	Universal SSL tunnel
sync *	Flush file system buffers
sysctl	Configure kernel parameters at runtime
syslogd	System logging utility
tar *	The tar archiving utility
tc	Show traffic control settings
tcpdump	Dump traffic on a network
telnetd	Telnet protocol server

APPENDIX A: Linux Commands and Source Code

tftp	Client to transfer a file from/to tftp server
tftpd	Trivial file Transfer Protocol (tftp) server
tip	Simple terminal emulator/cu program for connecting to modems and serial devices
top	Provide a view of process activity in real time
touch *	Change file timestamps
traceroute	Print the route packets take to network host
traceroute6	Traceroute for IPv6
true *	Returns an exit code of TRUE (0)
umount *	Unmounts file systems
uname *	Print system information
usleep *	Delay for a specified amount of time
vconfig *	Create and remove virtual Ethernet devices
vi *	Busybox clone of the VI text editor
w	Show who is logged on and what they are doing
zcat *	Identical to gunzip -c

Commands appended with “*” come from Busybox (the “Swiss Army Knife” of embedded Linux), found at <http://www.busybox.net/downloads/BusyBox.html>.

Others are generic Linux commands. Most commands use the **-h** or **--help** argument to provide a terse runtime description of their behavior. More details on the generic Linux commands can found online at <http://en.tldp.org/HOWTO/HOWTO-INDEX/howtos.html> and <http://www.faqs.org/docs/Linux-HOWTO/Remote-Serial-Console-HOWTO.html>.

Using the **ls** command lets you view all the commands available in your console server’s **/bin** directory.

A number of Tripp Lite tools listed above make it easy to configure the console server and ensure the changes are stored in the console server’s flash memory. These commands are covered in the previous chapters and include:

- **config** allows manipulation and querying of the system configuration from the command line. With config, a new configuration can be activated by running the relevant configurator, which performs the action necessary to make the configuration changes live.
- **portmanager** provides a buffered interface to each serial port. It is supported by the pmchat and pmshell commands, which ensure all serial port access is directed via the portmanager.
- **pmpower** is a configurable tool for manipulating remote power devices that are serially or network connected to the console server.
- **SDT Connector** is a java client applet that provides point-and-click SSH tunneled connections to the console server and managed devices.

There are also a number of other CLI commands related to other open source tools embedded in the console server, including:

- **PowerMan** provides power management for many preconfigured remote power controller (RPC) devices. For CLI details, go to <http://linux.die.net/man/1/powerman>.
- **Network UPS Tools (NUT)** provides reliable monitoring of UPS and PDU hardware and ensures safe shutdowns of connected systems. The aim is to monitor every kind of UPS and PDU. For CLI details, go to <http://www.networkupstools.org>.
- **Nagios** is a popular enterprise-class management tool that provides central monitoring of the hosts and services in distributed networks. For CLI details, go to <http://www.nagios.org>.

Many components of the console server software are licensed under the GNU General Public License (version 2), which Tripp Lite supports. You may obtain a copy of the GNU General Public License at <http://www.fsf.org/copyleft/gpl.html>. Source code will be provided for any of the components of the software licensed under the GNU General Public License upon request.

APPENDIX B: Hardware Specification

Feature	Value
Dimensions	B093-004-2E4U / B093-008-2E4U / B093-004-2E4U-V / B093-008-2E4U-V / B093-008-2E4U-M: 5 1/8 x 4 3/4 x 1 3/8 in. (13 x 12 x 3.5 cm) B097-016 / B097-048: 17 x 6.9 x 1.75 in. (44 x 17 x 4.5 cm) B098-016 / B098-048: 17 x 10 x 1.75 in. (44 x 25.4 x 4.5 cm)
Weight	B093-004-2E4U / B093-008-2E4U / B093-004-2E4U-V / B093-008-2E4U-V / B093-008-2E4U-M: 1.3 lb. (0.6 kg) B097-016 / B097-048: 9 lb. (4 kg) B098-016 / B098-048: 10 lb. (4.5 kg)
Ambient operating temperature	41°F to 122°F (5°C to 50°C)
Non-operating storage temp	-20°F to 140°F (-30°C to 60°C)
Humidity	5% to 90%
Power	Refer to section 2. Installation
Power consumption	All less than 30W

APPENDIX C: Safety and Certifications

Please follow the safety precautions below when installing and operating the console server:

- Do not remove the metal covers. There are no serviceable components inside. Opening or removing the cover may expose you to dangerous voltage, which may cause fire or electric shock. Refer all service to qualified Tripp Lite personnel.
- To avoid electric shock, the power cord protective grounding conductor must be connected through to ground.
- Always pull on the plug, not the cable, when disconnecting the power cord from the socket.

Do not connect or disconnect the console server during an electrical storm. It is recommended you use a surge protector or UPS to protect equipment from transient power fluctuations.

Use of this equipment in life support applications where failure of this equipment can reasonably be expected to cause the failure of the life support equipment or to significantly affect its safety or effectiveness is not recommended.

FCC Warning Statement

This device complies with Part 15 of the FCC rules. Operation of this device is subject to the following conditions: (1) This device may not cause harmful interference, and (2) this device must accept any interference that may cause undesired operation.

WEEE Compliance Information for Tripp Lite Customers and Recyclers (European Union)

 Under the Waste Electrical and Electronic Equipment (WEEE) Directive and implementing regulations, when customers buy new electrical and electronic equipment from Tripp Lite they are entitled to:

- Send old equipment for recycling on a one-for-one, like-for-like basis (this varies depending on the country)
- Send the new equipment back for recycling when this ultimately becomes waste

Regulatory Compliance Identification Numbers

For the purpose of regulatory compliance certifications and identification, your Tripp Lite product has been assigned a unique series number. The series number can be found on the product nameplate label, along with all required approval markings and information. When requesting compliance information for this product, always refer to the series number. The series number should not be confused with the marking name or model number of the product.

APPENDIX D: Connectivity, TCP Ports and Serial I/O

Pin-out standards exist for both DB9 and DB25 connectors. However, there are no pinout standards for serial connectivity using RJ45 connectors. Most console servers and serially managed servers / routers / switches / power devices have adopted their own unique pinout, so custom connectors and cables may be required to interconnect your console server.

Serial Port Pinout

Console servers come with one to forty eight serial connectors (notated SERIAL or SERIAL PORTS) for the RS-232 serial ports:

- The RJ45 serial ports are on the rear panel of the rack mount B098 and B097.
- The B093 and B097 models have Cisco Straight serial pinouts on its RJ45 connectors.
- The B098 has software selectable Cisco Straight or Cisco Rolled RJ45

Cisco Straight RJ45 pinout (option -X2)

Straight-through RJ45 cable to equipment such as Cisco, Juniper, SUN, and more.

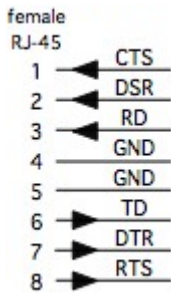
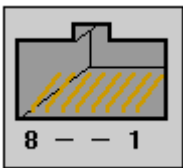

PIN	SIGNAL	DEFINITION	DIRECTION
1	CTS	Clear To Send	Input
2	DSR	Data Set Ready	Input
3	RXD	Receive Data	Input
4	GND	Signal Ground	NA
5	GND	Signal Ground	NA
6	TXD	Transmit Data	Output
7	DTR	Data Terminal Ready	Output
8	RTS	Request To Send	Output

Cisco Rolled RJ45 pinout (option -X1)

Easy to replace Avocent/Cyclades products, for use with rolled RJ-45 cable.

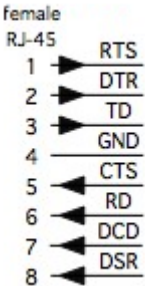
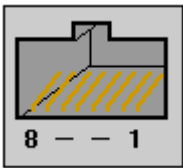

PIN	SIGNAL	DEFINITION	DIRECTION
1	RTS	Request To Send	Output
2	DTR	Data Terminal Ready	Output
3	TXD	Transmit Data	Output
4	GND	Signal Ground	NA
5	CTS	Clear To Send	Input
6	RXD	Receive Data	Input
7	DCD	Data Carrier Detect	Input
8	DSR	Data Set Ready	Input

APPENDIX D: Connectivity, TCP Ports and Serial I/O



Local Console Port

The LOCAL (console/modem) port on the Console Server uses a standard DB9 connector as tabled below:

RS-232 Standard Pinouts

The RS-232 pinout standards for the DB9 connectors are:

SIGNAL	DB9	DEFINITION
TXD	3	Transmitted Data
RXD	2	Received Data
RTS	7	Request To Send
CTS	8	Clear To Send
DSR	6	Data Set Ready
GND	5	Signal Ground
CD	1	Received Line Signal Detector
DTR	4	Data Terminal Ready
RI	9	Ring Indicator

	FEMALE	MALE
9 pin DB9		
8 pin RJ45		

Connectors Included with Console Server

DB9F-RJ45S straight connector



WIRING TABLE

RJ-45	DB9 F
1 CTS	8 CTS
2 DCD	1 DCD
3 RXD	2 RXD
4 N/C	
5 GND	5 GND
6 TXD	3 TXD
7 DTR	4 DTR
8 RTS	7 RTS

APPENDIX D: Connectivity, TCP Ports and Serial I/O

DB9F-RJ45S cross-over connector



WIRING TABLE

RJ-45	DB9 F
1 CTS -----	7 RTS
2 DCD -----	4 DTR
3 RXD -----	3 TXD
4 N/C	
5 GND -----	5 GND
6 TXD -----	2 RXD
7 DTR -----	1 DCD
	6 DSR
8 RTS -----	8 CTS

TCP/UDP Port Numbers

Port numbers are divided into three ranges: **Well-Known Ports**, **Registered Ports** and **Dynamic** and/or **Private Ports**. Well-Known Ports are those from 0 through 1023. Registered Ports are those from 1024 through 49151. Dynamic and/or Private Ports are those from 49152 through 65535.

Well-Known Ports are assigned by IANA. On most systems, they can only be used by system processes or by programs executed by privileged users. The table below shows some of the well-known port numbers. For more details, visit the IANA website: <http://www.iana.org/assignments/port-numbers>.

Port Number	Protocol	TCP/UDP
21	FTP (File Transfer Protocol)	TCP
22	SSH (Secure Shell)	TCP
23	Telnet	TCP
25	SMTP (Simple Mail Transfer Protocol)	TCP
37	Time	TCP, UDP
39	RLP (Resource Location Protocol)	UDP
49	TACACS, TACACS+	UDP
53	DNS	UDP
67	BOOTP server	UDP
68	BOOTP client	UDP
v69	TFTP	UDP
70	Gopher	TCP
79	Finger	TCP
80	HTTP	TCP
110	POP3	TCP
119	NNTP (Network News Transfer Protocol)	TCP
161/162	SNMP	UDP
443	HTTPS	TCP

APPENDIX E: Terminology

TERM	MEANING
3G	Third-generation cellular technology. The standards that determine 3G call for greater bandwidth and higher speeds for cellular networks.
AES	The Advanced Encryption Standard (AES) is a new block cipher standard to replace DES, developed by NIST, the US National Institute of Standards and Technology. AES ciphers use a 128-bit block and 128-, 192-, or 256-bit keys. The larger block size helps resist birthday attacks, while the large key size prevents brute force attacks.
APN	Access Point Name (APN) is used by carriers to identify an IP packet data network that a mobile data user wants to communicate with and the type of wireless service.
Authentication	SMTP (Simple Mail Transfer Protocol)
	Authentication is the technique by which a process verifies that its communication partner is who it is supposed to be and not an imposter. Authentication confirms that data is sent to the intended recipient and assures the recipient that the data originated from the expected sender and has not been altered on route.
BIOS	Basic Input/Output System is the built-in software in a computer executed on startup (boot) that determines what the computer can do without accessing programs from a disk. On PCs, the BIOS contains all the code required to control the keyboard, display screen, disk drives, serial communications, and a number of miscellaneous functions.
Bonding	Ethernet Bonding or Failover is the ability to detect communication failure transparently and switch from one LAN connection to another.
BOOTP	Bootstrap Protocol. A protocol that allows a network user to automatically receive an IP address and have an operating system boot without user interaction. BOOTP is the basis for the more advanced DHCP.
Certificates	A digitally signed statement that contains information about an entity and the entity's public key, thus binding these two pieces of information together. A certificate is issued by a trusted organization (or entity) called a Certification Authority (CA) after the CA has verified that the entity is who it says it is.
Certificate Authority	A Certificate Authority is a trusted third party, which certifies public keys that truly belong to their claimed owners. It is a key part of any Public Key Infrastructure, since it allows users to trust that a given public key is the one they wish to use, either to send a private message to its owner or to verify the signature on a message sent by that owner.
Certificate Revocation List	A list of certificates that have been revoked by the CA before they expired. This may be necessary if the private key certificate has been compromised or if the holder of the certificate is denied the ability to establish a connection to the console server.
CHAP	Challenge-Handshake Authentication Protocol (CHAP) is used to verify a user's name and password for PPP Internet connections. It is more secure than PAP, the other main authentication protocol.
DES	The Data Encryption Standard is a block cipher with 64-bit blocks and a 56-bit key.
DHCP	Dynamic Host Configuration Protocol. A communications protocol that assigns IP addresses to computers when they are connected to the network.
DNS	Domain Name System allocates Internet domain names and translates them into IP addresses. A domain name is a meaningful and easy to remember name for an IP address.
DUN	Dial-Up Networking.
Encryption	The technique for converting a readable message (plaintext) into apparently random material (ciphertext) which cannot be read if intercepted. The proper decryption key is required to read the message.
Ethernet	A physical layer protocol based upon IEEE standards.
Firewall	A network gateway device that protects a private network from users on other networks. A firewall is usually installed to allow users on an intranet access to the public Internet without allowing public Internet users access to the intranet.

APPENDIX E: Terminology

TERM	MEANING
Gateway	A machine that provides a route (or pathway) to the outside world.
Hub	A network device that allows more than one computer to be connected as a LAN, usually using UTP cabling.
Internet	A worldwide system of computer networks - a public, cooperative, and self-sustaining network of networks accessible to hundreds of millions of people worldwide. The Internet is technically distinguished because it uses the TCP/IP set of protocols.
Intranet	A private TCP/IP network within an enterprise.
IPMI	Intelligent Platform Management Interface (IPMI) is a set of common interfaces to a computer system that system administrators can use to monitor system health and manage the system. The IPMI standard defines the protocols for interfacing with a service processor embedded into a server platform.
Key lifetimes	The length of time before keys are renegotiated.
LAN	Local Area Network.
LDAP	The Lightweight Directory Access Protocol (LDAP) is based on the X.500 standard, but significantly simpler and more readily adapted to meet custom needs. The core LDAP specifications are all defined in RFCs. LDAP is a protocol used to access information stored in an LDAP server.
LED	Light-Emitting Diode.
MAC address	Every piece of Ethernet hardware has a unique number assigned to it called its MAC address. Ethernet is used locally to connect the console server to the Internet, and it may share the local network with many other devices. The MAC address is used by the local Internet router in order to direct console server traffic to it rather than someone else in the local area. It is a 48-bit number usually written as a series of 6 hexadecimal octets (e.g., 00:d0:cf:00:5b:da). A console server has a MAC address listed on a label underneath the device.
MSCHAP	Microsoft Challenge Handshake Authentication Protocol (MSCHAP) is authentication for PPP connections between a computer using a Microsoft Windows operating system and a network access server. It is more secure than PAP or CHAP, and is the only option that also supports data encryption.
NAT	Network Address Translation. The translation of an IP address used on one network to an IP address on another network. Masquerading is one particular form of NAT.
Net mask	The way that computers know which part of a TCP/IP address refers to the network, and which part refers to the host range.
NFS	Network File System is a protocol that allows file sharing across a network. Users can view, store, and update files on a remote computer.
NTP	Network Time Protocol (NTP) used to synchronize clock times in a network of computers.
OUT OF BAND	Out-of-Band (OOB) management is any management done over channels and interfaces that are separate from those used for user/customer data. Examples include a serial console interface or a network interface connected to a dedicated management network that is not used to carry customer traffic, or to a BMC/service processor. Any management done over the same channels and interfaces used for user/customer data is In Band.
PAP	Password Authentication Protocol (PAP) is the usual method of user authentication used on the internet: sending a username and password to a server where they are compared with a table of authorized users. Whilst most common, PAP is the least secure of the authentication options.
PPP	Point-to-Point Protocol. A networking protocol for establishing simple links between two peers.
RADIUS	The Remote Authentication Dial-In User Service (RADIUS) protocol was developed by Livingston Enterprises as an access server authentication and accounting protocol. The RADIUS server can support a variety of methods to authenticate a user. When it is provided with the username and original password given by the user, it can support PPP, PAP or CHAP, UNIX login, and other authentication mechanisms.

APPENDIX E: Terminology

TERM	MEANING
Router	A network device that moves packets of data. A router differs from hubs and switches because it is "intelligent" and can route packets to their final destination.
SIM	Subscriber Identity Module (SIM) card stores unique serial numbers and security authentication used to identify a subscriber on mobile telephony devices.
SMASH	Systems Management Architecture for Server Hardware is a standards-based protocols aimed at increasing productivity of the management of a data center. The SMASH Command Line Protocol (SMASH CLP) specification provides an intuitive interface to heterogeneous servers independent of machine state, operating system or OS state, system topology or access method. It is a standard method for local and remote management of server hardware using out-of-band communication.
SMTP	Simple Mail Transfer Protocol. The console server includes SMTPclient, a minimal SMTP client that takes an email message body and passes it on to an SMTP server (default is the MTA on the local host).
SOL	Serial Over LAN (SOL) enables servers to transparently redirect the serial character stream from the baseboard universal asynchronous receiver/transmitter (UART) to and from the remote-client system over a LAN. With SOL support and BIOS redirection (to serial), remote managers can view the BIOS/POST output when powered on and reconfigured.
SSH	Secure Shell is secure transport protocol based on public-key cryptography.
SSL	Secure Sockets Layer is a protocol that provides authentication and encryption services between a web server and a web browser.
TACACS+	The Terminal Access Controller Access Control System (TACACS+) security protocol is a more recent protocol developed by Cisco. It provides detailed accounting information and flexible administrative control over the authentication and authorization processes. TACACS+ allows for a single access control server (the TACACS+ daemon) to provide authentication, authorization, and accounting services independently. Each service can be tied into its own database to take advantage of other services available on that server or on the network, depending on the capabilities of the daemon. There is a draft RFC detailing this protocol.
TCP/IP	Transmission Control Protocol/Internet Protocol. The basic protocol for Internet communication.
TCP/IP address	Fundamental Internet addressing method that uses the form nnn.nnn.nnn.nnn.
Telnet	Telnet is a terminal protocol that provides an easy-to-use method of creating terminal connections to a network.
UDP	User Datagram Protocol.
UTC	Coordinated Universal Time.
UTP	Unshielded Twisted Pair cabling. A type of Ethernet cable that can operate up to 100Mb/s. Also known as Category 5 or Cat5.
VNC	Virtual Network Computing (VNC) is a desktop protocol to remotely control another computer. It transmits the keyboard presses and mouse clicks from one computer to another, relaying the screen updates back in the other direction and over a network.
VPN	Virtual Private Network (VPN) is a network that uses a public telecommunication infrastructure and Internet to provide remote offices or individual users with secure access to their organization's network.
WAN	Wide Area Network.
WINS	Windows Internet Naming Service (WINS) manages the association of workstation names and locations with IP addresses.

APPENDIX F: End User License Agreements

READ BEFORE USING THE ACCOMPANYING SOFTWARE

CAREFULLY READ THE FOLLOWING TERMS AND CONDITIONS BEFORE USING THE ACCOMPANYING SOFTWARE, THE USE OF WHICH IS LICENSED FOR USE ONLY AS SET FORTH BELOW. IF YOU DO NOT AGREE TO THE TERMS AND CONDITIONS OF THIS AGREEMENT, DO NOT USE THE SOFTWARE. IF YOU USE ANY PART OF THE SOFTWARE, SUCH USE WILL INDICATE THAT YOU ACCEPT THESE TERMS.

You have acquired a product that includes Tripp Lite (“Tripp Lite”) proprietary software and/or proprietary software licensed to Tripp Lite. This Tripp Lite End User License Agreement (“EULA”) is a legal agreement between you (either an individual or a single entity) and Tripp Lite for the installed software product of Tripp Lite origin, as well as associated media, printed materials, and “online” or electronic documentation (“Software”). By installing, copying, downloading, accessing, or otherwise using the Software, you agree to be bound by the terms of this EULA. If you do not agree to the terms of this EULA, Tripp Lite is not willing to license the Software to you. In such event, do not use or install the Software. If you have purchased the Software, promptly return the Software and all accompanying materials with proof of purchase for a refund.

Products with separate end user license agreements that may be provided along with the Software are licensed to you under the terms of those separate end user license agreements.

LICENSE GRANT. Subject to the terms and conditions of this EULA, Tripp Lite grants you a nonexclusive right and license to install and use the Software on a single CPU, provided that, (1) you may not rent, lease, sell, sublicense or lend the Software; (2) you may not reverse engineer, decompile, disassemble or modify the Software, except and only to the extent that such activity is expressly permitted by applicable law notwithstanding this limitation; and (3) you may not transfer rights under this EULA unless such transfer is part of a permanent sale or transfer of the Product, you transfer at the same time all copies of the Software to the same party or destroy such materials not transferred, and the recipient agrees to this EULA.

No license is granted in any of the Software’s proprietary source code. This license does not grant you any rights to patents, copyright, trade secrets, trademarks or any other rights with respect to the Software.

You may make a reasonable number of copies of the electronic documentation accompanying the Software for each Software license you acquire, provided that, you must reproduce and include all copyright notices and any other proprietary rights notices appearing on the electronic documentation. Tripp Lite reserves all rights not expressly granted herein.

INTELLECTUAL PROPERTY RIGHTS. The Software is protected by copyright laws, international copyright treaties, and other intellectual property laws and treaties. Tripp Lite and its suppliers retain all ownership of, and intellectual property rights in (including copyright), the Software components and all copies thereof, provided however, that (1) certain components of the Software, including SDT Connector, are components licensed under the GNU General Public License Version 2, which Tripp Lite supports, and (2) the SDT Connector includes code from JSch, a pure Java implementation of SSH2 which is licensed under BSD style license. Copies of these licenses are detailed below and Tripp Lite will provide source code for any of the components of the Software licensed under the GNU General Public License upon request.

EXPORT RESTRICTIONS. You agree that you will not export or re-export the Software, any part thereof, or any process or service that is the direct product of the Software in violation of any applicable laws or regulations of the United States or the country in which you obtained them.

U.S. GOVERNMENT RESTRICTED RIGHTS. The Software and related documentation are provided with Restricted Rights. Use, duplication, or disclosure by the Government is subject to restrictions set forth in subparagraph (c) (1) (ii) of the Rights in Technical Data and Computer Software clause at DFARS 252.227-7013 or subparagraphs (c) (1) and (2) of the Commercial Computer Software – Restricted Rights at 48 C.F.R. 52.227-19, as applicable, or any successor regulations.

TERM AND TERMINATION. This EULA is effective until terminated. The EULA terminates immediately if you fail to comply with any term or condition. In such an event, you must destroy all copies of the Software. You may also terminate this EULA at any time by destroying the Software.

GOVERNING LAW AND ATTORNEY’S FEES. This EULA is governed by the laws of the State of Utah, USA, excluding its conflict of law rules. You agree that the United Nations Convention on Contracts for the International Sale of Goods is hereby excluded in its entirety and does not apply to this EULA. If you acquired this Software in a country outside of the United States, that country’s laws may apply. In any action or suit to enforce any right or remedy under this EULA or to interpret any provision of this EULA, the prevailing party will be entitled to recover its costs, including reasonable attorneys’ fees.

ENTIRE AGREEMENT. This EULA constitutes the entire agreement between you and Tripp Lite with respect to the Software, and supersedes all other agreements or representations, whether written or oral. The terms of this EULA can only be modified by express written consent of both parties. If any part of this EULA is held to be unenforceable as written, it will be enforced to the maximum extent allowed by applicable law, and will not affect the enforceability of any other part.

APPENDIX F: End User License Agreements

Should you have any questions concerning this EULA, or if you desire to contact Tripp Lite for any reason, please contact the Tripp Lite representative serving your company.

THE FOLLOWING DISCLAIMER OF WARRANTY AND LIMITATION OF LIABILITY IS INCORPORATED INTO THIS EULA BY REFERENCE. THE SOFTWARE IS NOT FAULT TOLERANT. YOU HAVE INDEPENDENTLY DETERMINED HOW TO USE THE SOFTWARE IN THE DEVICE, AND TRIPP LITE HAS RELIED UPON YOU TO CONDUCT SUFFICIENT TESTING TO DETERMINE THAT THE SOFTWARE IS SUITABLE FOR SUCH USE.

LIMITED WARRANTY Tripp Lite warrants the media containing the Software for a period of ninety (90) days from the date of original purchase from Tripp Lite or its authorized retailer. Proof of date of purchase will be required. Any updates to the Software provided by Tripp Lite (which may be provided by Tripp Lite at its sole discretion) shall be governed by the terms of this EULA. In the event the product fails to perform as warranted, Tripp Lite's sole obligation shall be, at Tripp Lite's discretion, to refund the purchase price paid by you for the Software on the defective media, or to replace the Software on new media. Tripp Lite makes no warranty or representation that its Software will meet your requirements, will work in combination with any hardware or application software products provided by third parties, that the operation of the software products will be uninterrupted or error free, or that all defects in the Software will be corrected.

TRIPP LITE DISCLAIMS ANY AND ALL OTHER WARRANTIES, WHETHER EXPRESS OR IMPLIED, INCLUDING WITHOUT LIMITATION, ANY IMPLIED WARRANTIES OF MERCHANTABILITY OR FITNESS FOR A PARTICULAR PURPOSE. OTHER THAN AS STATED HEREIN, THE ENTIRE RISK AS TO SATISFACTORY QUALITY, PERFORMANCE, ACCURACY, AND EFFORT IS WITH YOU. ALSO, THERE IS NO WARRANTY AGAINST INTERFERENCE WITH YOUR ENJOYMENT OF THE SOFTWARE OR AGAINST INFRINGEMENT. IF YOU HAVE RECEIVED ANY WARRANTIES REGARDING THE DEVICE OR THE SOFTWARE, THOSE WARRANTIES DO NOT ORIGINATE FROM, AND ARE NOT BINDING ON, TRIPP LITE.

NO LIABILITY FOR CERTAIN DAMAGES. EXCEPT AS PROHIBITED BY LAW, TRIPP LITE SHALL HAVE NO LIABILITY FOR COSTS, LOSS, DAMAGES OR LOST OPPORTUNITY OF ANY TYPE WHATSOEVER, INCLUDING BUT NOT LIMITED TO, LOST OR ANTICIPATED PROFITS, LOSS OF USE, LOSS OF DATA, OR ANY INCIDENTAL, EXEMPLARY SPECIAL OR CONSEQUENTIAL DAMAGES, WHETHER UNDER CONTRACT, TORT, WARRANTY OR OTHERWISE ARISING FROM OR IN CONNECTION WITH THIS EULA OR THE USE OR PERFORMANCE OF THE SOFTWARE. IN NO EVENT SHALL TRIPP LITE BE LIABLE FOR ANY AMOUNT IN EXCESS OF THE LICENSE FEE PAID TO TRIPP LITE UNDER THIS EULA. SOME STATES AND COUNTRIES DO NOT ALLOW THE LIMITATION OR EXCLUSION OF LIABILITY FOR INCIDENTAL OR CONSEQUENTIAL DAMAGES, SO THIS LIMITATION MAY NOT APPLY TO YOU.

JSch License

SDT Connector includes code from JSch, a pure Java implementation of SSH2. JSch is licensed under BSD style license and is: Copyright (c) 2002, 2003, 2004 Atsuhiko Yamanaka, JCraft, Inc. All rights reserved.

Redistribution and use in source and binary forms, with or without modification, are permitted provided that the following conditions are met:

1. Redistributions of source code must retain the above copyright notice, this list of conditions and the following disclaimer.
2. Redistributions in binary form must reproduce the above copyright notice, this list of conditions and the following disclaimer in the documentation and/or other materials provided with the distribution.
3. The names of the authors may not be used to endorse or promote products derived from this software without specific prior written permission.

THIS SOFTWARE IS PROVIDED ``AS IS'' AND ANY EXPRESSED OR IMPLIED WARRANTIES, INCLUDING, BUT NOT LIMITED TO, THE IMPLIED WARRANTIES OF MERCHANTABILITY AND FITNESS FOR A PARTICULAR PURPOSE ARE DISCLAIMED. IN NO EVENT SHALL JCRAFT, INC. OR ANY CONTRIBUTORS TO THIS SOFTWARE BE LIABLE FOR ANY DIRECT, INDIRECT, INCIDENTAL, SPECIAL, EXEMPLARY, OR CONSEQUENTIAL DAMAGES (INCLUDING, BUT NOT LIMITED TO, PROCUREMENT OF SUBSTITUTE GOODS OR SERVICES; LOSS OF USE, DATA, OR PROFITS; OR BUSINESS INTERRUPTION) HOWEVER CAUSED AND ON ANY THEORY OF LIABILITY, WHETHER IN CONTRACT, STRICT LIABILITY, OR TORT (INCLUDING NEGLIGENCE OR OTHERWISE) ARISING IN ANY WAY OUT OF THE USE OF THIS SOFTWARE, EVEN IF ADVISED OF THE POSSIBILITY OF SUCH DAMAGE.

APPENDIX F: End User License Agreements

GNU GENERAL PUBLIC LICENSE

Version 2, June 1991

Copyright (C) 1989, 1991 Free Software Foundation, Inc.
51 Franklin Street, Fifth Floor, Boston, MA 02110-1301, USA

Everyone is permitted to copy and distribute verbatim copies of this license document, but changing it is not allowed.

GNU GENERAL PUBLIC LICENSE

TERMS AND CONDITIONS FOR COPYING, DISTRIBUTION AND MODIFICATION

0. This License applies to any program or other work which contains a notice placed by the copyright holder saying it may be distributed under the terms of this General Public License. The “Program”, below, refers to any such program or work, and a “work based on the Program” means either the Program or any derivative work under copyright law: that is to say, a work containing the Program or a portion of it, either verbatim or with modifications and/or translated into another language. (Hereinafter, translation is included without limitation in the term “modification”.) Each licensee is addressed as “you”.

Activities other than copying, distribution and modification are not covered by this License; they are outside its scope. The act of running the Program is not restricted, and the output from the Program is covered only if its contents constitute a work based on the Program (independent of having been made by running the Program). Whether that is true depends on what the Program does.

1. You may copy and distribute verbatim copies of the Program’s source code as you receive it, in any medium, provided that you conspicuously and appropriately publish on each copy an appropriate copyright notice and disclaimer of warranty; keep intact all the notices that refer to this License and to the absence of any warranty; and give any other recipients of the Program a copy of this License along with the Program.

You may charge a fee for the physical act of transferring a copy, and you may at your option offer warranty protection in exchange for a fee.

2. You may modify your copy or copies of the Program or any portion of it, thus forming a work based on the Program, and copy and distribute such modifications or work under the terms of Section 1 above, provided that you also meet all of these conditions:

- a) You must cause the modified files to carry prominent notices stating that you changed the files and the date of any change.
- b) You must cause any work that you distribute or publish, that in whole or in part contains or is derived from the Program or any part thereof, to be licensed as a whole at no charge to all third parties under the terms of this License.
- c) If the modified program normally reads commands interactively when run, you must cause it, when started running for such interactive use in the most ordinary way, to print or display an announcement including an appropriate copyright notice and a notice that there is no warranty (or else, saying that you provide a warranty) and that users may redistribute the program under these conditions, and telling the user how to view a copy of this License. (Exception: if the Program itself is interactive but does not normally print such an announcement, your work based on the Program is not required to print an announcement.)

These requirements apply to the modified work as a whole. If identifiable sections of that work are not derived from the Program, and can be reasonably considered independent and separate works in themselves, then this License, and its terms, do not apply to those sections when you distribute them as separate works. But when you distribute the same sections as part of a whole which is a work based on the Program, the distribution of the whole must be on the terms of this License, whose permissions for other licensees extend to the entire whole, and thus to each and every part regardless of who wrote it.

Thus, it is not the intent of this section to claim rights or contest your rights to work written entirely by you; rather, the intent is to exercise the right to control the distribution of derivative or collective works based on the Program.

In addition, mere aggregation of another work not based on the Program with the Program (or with a work based on the Program) on a volume of a storage or distribution medium does not bring the other work under the scope of this License.

APPENDIX F: End User License Agreements

3. You may copy and distribute the Program (or a work based on it, under Section 2) in object code or executable form under the terms of Sections 1 and 2 above provided that you also do one of the following:

- a) Accompany it with the complete corresponding machine-readable source code, which must be distributed under the terms of Sections 1 and 2 above on a medium customarily used for software interchange; or,
- b) Accompany it with a written offer, valid for at least three years, to give any third party, for a charge no more than your cost of physically performing source distribution, a complete machine-readable copy of the corresponding source code, to be distributed under the terms of Sections 1 and 2 above on a medium customarily used for software interchange; or,
- c) Accompany it with the information you received as to the offer to distribute corresponding source code. (This alternative is allowed only for noncommercial distribution and only if you received the program in object code or executable form with such an offer, in accord with Subsection b above).

The source code for a work means the preferred form of the work for making modifications to it. For an executable work, complete source code means all the source code for all modules it contains, plus any associated interface definition files, plus the scripts used to control compilation and installation of the executable. However, as a special exception, the source code distributed need not include anything that is normally distributed (in either source or binary form) with the major components (compiler, kernel, and so on) of the operating system on which the executable runs, unless that component itself accompanies the executable.

If distribution of executable or object code is made by offering access to copy from a designated place, then offering equivalent access to copy the source code from the same place counts as distribution of the source code, even though third parties are not compelled to copy the source along with the object code.

4. You may not copy, modify, sublicense, or distribute the Program except as expressly provided under this License. Any attempt otherwise to copy, modify, sublicense or distribute the Program is void, and will automatically terminate your rights under this License. However, parties who have received copies, or rights, from you under this License will not have their licenses terminated so long as such parties remain in full compliance.

5. You are not required to accept this License, since you have not signed it. However, nothing else grants you permission to modify or distribute the Program or its derivative works. These actions are prohibited by law if you do not accept this License. Therefore, by modifying or distributing the Program (or any work based on the Program), you indicate your acceptance of this License to do so, and all its terms and conditions for copying, distributing or modifying the Program or works based on it.

6. Each time you redistribute the Program (or any work based on the Program), the recipient automatically receives a license from the original licensor to copy, distribute or modify the Program subject to these terms and conditions. You may not impose any further restrictions on the recipients' exercise of the rights granted herein. You are not responsible for enforcing compliance by third parties to this License.

7. If, as a consequence of a court judgment or allegation of patent infringement or for any other reason (not limited to patent issues), conditions are imposed on you (whether by court order, agreement or otherwise) that contradict the conditions of this License, they do not excuse you from the conditions of this License. If you cannot distribute so as to satisfy simultaneously your obligations under this License and any other pertinent obligations, then as a consequence you may not distribute the Program at all. For example, if a patent license would not permit royalty-free redistribution of the Program by all those who receive copies directly or indirectly through you, then the only way you could satisfy both it and this License would be to refrain entirely from distribution of the Program.

If any portion of this section is held invalid or unenforceable under any particular circumstance, the balance of the section is intended to apply and the section as a whole is intended to apply in other circumstances.

It is not the purpose of this section to induce you to infringe any patents or other property right claims or to contest validity of any such claims; this section has the sole purpose of protecting the integrity of the free software distribution system, which is implemented by public license practices. Many people have made generous contributions to the wide range of software distributed through that system in reliance on consistent application of that system; it is up to the author/donor to decide if he or she is willing to distribute software through any other system and a licensee cannot impose that choice.

This section is intended to make thoroughly clear what is believed to be a consequence of the rest of this License.

8. If the distribution and/or use of the Program is restricted in certain countries either by patents or by copyrighted interfaces, the original copyright holder who places the Program under this License may add an explicit geographical distribution limitation excluding those countries, so that distribution is permitted only in or among countries not thus excluded. In such case, this License incorporates the limitation as if written in the body of this License.

APPENDIX F: End User License Agreements

9. The Free Software Foundation may publish revised and/or new versions of the General Public License from time to time. Such new versions will be similar in spirit to the present version, but may differ in detail to address new problems or concerns.

Each version is given a distinguishing version number. If the Program specifies a version number of this License which applies to it and “any later version”, you have the option of following the terms and conditions either of that version or of any later version published by the Free Software Foundation. If the Program does not specify a version number of this License, you may choose any version ever published by the Free Software Foundation.

10. If you wish to incorporate parts of the Program into other free programs whose distribution conditions are different, write to the author to ask for permission. For software which is copyrighted by the Free Software Foundation, write to the Free Software Foundation; we sometimes make exceptions for this. Our decision will be guided by the two goals of preserving the free status of all derivatives of our free software and of promoting the sharing and reuse of software generally.

NO WARRANTY

11. BECAUSE THE PROGRAM IS LICENSED FREE OF CHARGE, THERE IS NO WARRANTY FOR THE PROGRAM, TO THE EXTENT PERMITTED BY APPLICABLE LAW. EXCEPT WHEN OTHERWISE STATED IN WRITING THE COPYRIGHT HOLDERS AND/OR OTHER PARTIES PROVIDE THE PROGRAM “AS IS” WITHOUT WARRANTY OF ANY KIND, EITHER EXPRESSED OR IMPLIED, INCLUDING, BUT NOT LIMITED TO, THE IMPLIED WARRANTIES OF MERCHANTABILITY AND FITNESS FOR A PARTICULAR PURPOSE. THE ENTIRE RISK AS TO THE QUALITY AND PERFORMANCE OF THE PROGRAM IS WITH YOU. SHOULD THE PROGRAM PROVE DEFECTIVE, YOU ASSUME THE COST OF ALL NECESSARY SERVICING, REPAIR OR CORRECTION.

12. IN NO EVENT UNLESS REQUIRED BY APPLICABLE LAW OR AGREED TO IN WRITING WILL ANY COPYRIGHT HOLDER, OR ANY OTHER PARTY WHO MAY MODIFY AND/OR REDISTRIBUTE THE PROGRAM AS PERMITTED ABOVE, BE LIABLE TO YOU FOR DAMAGES, INCLUDING ANY GENERAL, SPECIAL, INCIDENTAL OR CONSEQUENTIAL DAMAGES ARISING OUT OF THE USE OR INABILITY TO USE THE PROGRAM (INCLUDING BUT NOT LIMITED TO LOSS OF DATA OR DATA BEING RENDERED INACCURATE OR LOSSES SUSTAINED BY YOU OR THIRD PARTIES OR A FAILURE OF THE PROGRAM TO OPERATE WITH ANY OTHER PROGRAMS), EVEN IF SUCH HOLDER OR OTHER PARTY HAS BEEN ADVISED OF THE POSSIBILITY OF SUCH DAMAGES.

APPENDIX G: Service and Limited Warranty

Service

Your Tripp Lite product is covered by the warranty described in this manual. A variety of Extended Warranty and On-Site Service Programs are also available from Tripp Lite. For more information on service, visit www.tripplite.com/support. Before returning your product for service, follow these steps:

Review the installation and operation procedures in this manual to insure that the service problem does not originate from a misreading of the instructions.

If the problem continues, do not contact or return the product to the dealer. Instead, visit www.tripplite.com/support.

If the problem requires service, visit www.tripplite.com/support and click the Product Returns link. From here you can request a Returned Material Authorization (RMA) number, which is required for service. This simple on-line form will ask for your unit's model and serial numbers, along with other general purchaser information. The RMA number, along with shipping instructions will be emailed to you. Any damages (direct, indirect, special or consequential) to the product incurred during shipment to Tripp Lite or an authorized Tripp Lite service center is not covered under warranty. Products shipped to Tripp Lite or an authorized Tripp Lite service center must have transportation charges prepaid. Mark the RMA number on the outside of the package. If the product is within its warranty period, enclose a copy of your sales receipt. Return the product for service using an insured carrier to the address given to you when you request the RMA.

4-Year Limited Warranty

TRIPP LITE warrants its products to be free from defects in materials and workmanship for a period of two (4) years from the date of initial purchase. TRIPP LITE's obligation under this warranty is limited to repairing or replacing (at its sole option) any such defective products. To obtain service under this warranty, you must obtain a Returned Material Authorization (RMA) number from TRIPP LITE or an authorized TRIPP LITE service center. Products must be returned to TRIPP LITE or an authorized TRIPP LITE service center with transportation charges prepaid and must be accompanied by a brief description of the problem encountered and proof of date and place of purchase. This warranty does not apply to equipment which has been damaged by accident, negligence or misapplication or has been altered or modified in any way.

EXCEPT AS PROVIDED HEREIN, TRIPP LITE MAKES NO WARRANTIES, EXPRESS OR IMPLIED, INCLUDING WARRANTIES OF MERCHANTABILITY AND FITNESS FOR A PARTICULAR PURPOSE. Some states do not permit limitation or exclusion of implied warranties; therefore, the aforesaid limitation(s) or exclusion(s) may not apply to the purchaser.

EXCEPT AS PROVIDED ABOVE, IN NO EVENT WILL TRIPP LITE BE LIABLE FOR DIRECT, INDIRECT, SPECIAL, INCIDENTAL OR CONSEQUENTIAL DAMAGES ARISING OUT OF THE USE OF THIS PRODUCT, EVEN IF ADVISED OF THE POSSIBILITY OF SUCH DAMAGE. Specifically, TRIPP LITE is not liable for any costs, such as lost profits or revenue, loss of equipment, loss of use of equipment, loss of software, loss of data, costs of substitutes, claims by third parties, or otherwise.

Tripp Lite has a policy of continuous improvement. Specifications are subject to change without notice. Photos and illustrations may differ slightly from actual products.



1111 W. 35th Street, Chicago, IL 60609 USA • tripplite.com/support